



STORMSHIELD

E W I & R E N D E R

E X T E R N A L W A L L
I N S U L A T I O N

A COMPLETE APPLICATION GUIDE





STORMSHIELD

EWI & RENDER

EXTERNAL WALL INSULATION APPLICATION GUIDE

Please read this document in full before commencing any Johnstone's Stormshield External Wall Insulation projects – even if you are an experienced applicator – as it contains the installation and technical advice required to ensure a high quality finish is achieved.

Reference should also be made to Johnstone's Stormshield product data sheets and product packaging information to ensure safe and appropriate use.

Please note that any installation advice contained in this guide is only provided for application guidance. The system installer must satisfy itself that its requirements are met by any recommendations in this guide and if necessary should procure advice from an appropriate engineering, architectural, building and/or other expert as to the appropriate combinations of EWI products.

Johnstone's reserves the right to amend this document where necessary to comply with any applicable statutory, regulatory or safety requirements.

For additional information please contact your Technical Sales Manager or contact PPG using the contact information provided in this guide.

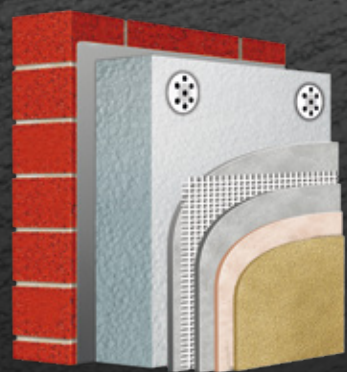

Johnstone's Stormshield Silicone Finish



Johnstone's Stormshield Dash Finish



Johnstone's Stormshield Brick Effect Render



GENERAL STORAGE INFORMATION

- Bagged products such as Johnstone's Stormshield insulation adhesive, basecoat and dash receivers must be stored off the ground and protected from water damage.
- Johnstone's Stormshield powder products contain cement and are highly sensitive to damp. Any damp or moisture ingress to the powders prior to use may make them unsuitable for use.
- Stored under proper conditions, Johnstone's bagged products have a shelf life of 12 months.
- All Johnstone's Stormshield silicone primer and render products must be stored frost free and protected from extreme heat.
- Insulation panels must be protected from rain and physical damage. Factory packaging does not provide a level of protection which would allow the materials to be stored outside.
- Care should be taken in the handling and storage of all Johnstone's Stormshield External Wall Insulation materials in line with the product datasheets.



MIXING PRODUCT

- Correctly mix powder product with suitable equipment in full accordance to the product specification. Always discard materials if there is suspicion of damp or contamination.
- Once material has been mixed if not used immediately do not attempt to add additional water at a later stage to improve the consistency of any Johnstone's Stormshield products.
- When using coloured renders it is always advisable to check the batch numbers are the same and to mix multiple bags or buckets together prior to application to create high levels of colour accuracy. Whilst every attempt is taken to ensure colour consistency in highly controlled factory and tinting operations some colour variances may occur.



SUITABLE WEATHER CONDITIONS

- *  Drying times will vary significantly depending on wind, temperature and humidity and may take longer than specified in adverse conditions.
- Do not work with frosted materials or on frosted substrates.
- Do not apply adhesives, basecoats, dash receiver or renders in temperatures below 5°C or when frost is likely to occur during a period of 24 hours after application.
- In cold weather, if frost is forecast, stop work in time to allow the material to set sufficiently to prevent frost damage.
- Do not work in high temperatures or on surfaces directly exposed to strong sunlight.
- Do not work during rainfall or if rainfall is anticipated during initial set.
- Do not allow rain to strike newly applied material until it has time to set.
- Application in unsuitable conditions may invalidate any Johnstone's Stormshield warranties.



PROTECT AGAINST RAIN & WATER

- Protect Johnstone's adhesive, basecoat, dash receiver and render from rain during their initial setting period. If necessary screen off the surface using appropriate covers to create an enclosed work area.
- Protect surfaces against water damage from gutters or other fittings removed during application by providing appropriate temporary arrangements to divert water away from wall surfaces.
- Artificial enclosures around scaffolding can be formed using tarpaulins, close mesh netting, polythene or other suitable material to overcome adverse weather conditions.

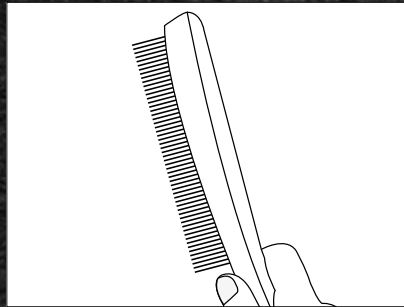

- Always ensure that the surface to be covered is clean and free from dirt

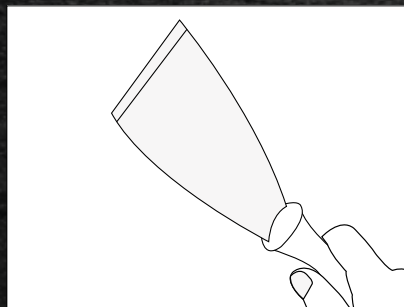

- Previously painted masonry surfaces should be scraped off

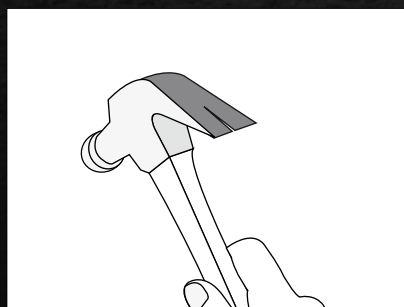

- Use a hammer test to identify areas of defect

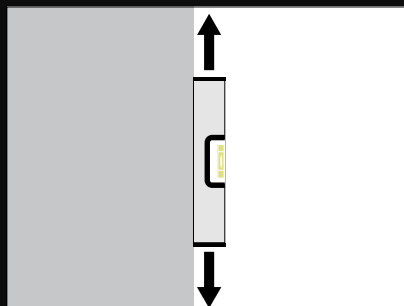

- Ensure wall is level and clear

PREPARATION

Johnstone's Stormshield External Wall Insulation Systems must be applied to a sound, stable and level substrate. It is important that the surface is properly prepared prior to commencing work.

- Always correctly prepare the area before commencing any work.
- Remove all objects attached to the property walls including satellite dishes, downpipes & gates.
- Ensure the area is clear from any plants and all wall surfaces are visible and accessible.

Ensure a clean, stable & level substrate

Always ensure that the surface to be covered is clean and free from dirt, algae and lichen.

- All wall surfaces should be cleaned of any ingrained dirt and dust using suitable equipment.
- On any areas of fungal or algal growth apply a suitable fungicidal wash by hand or spray, leave for the specified time and clean the surface thoroughly.

Additionally the following preparation may be required based on the condition of the substrate, the building height and the specification provided:

- On previously rendered or coated surfaces check to ensure that the substrate is sound. Use a hammer test on suspect wall surfaces and render areas to identify areas of defect.
- Hack off defective areas of wall surface until a solid substrate is achieved and remove any protrusions that are not level to the wall.
- Make good the substrate where required to ensure a suitable and stable base for the application of Johnstone's Stormshield External Wall Insulation.
- When using insulation panel adhesive on friable or flaking masonry substrates it may be necessary to seal and bind the surface with Johnstone's Stormshield Stabilising Solution.
- When using insulation panel adhesive on previously painted masonry surfaces, they should be treated with paint remover and coatings scraped or brushed off prior to application.

PROTECTION

Please take care to thoroughly mask and protect all areas not being rendered. Johnstone's Stormshield products contain highly adhesive materials that may be difficult to remove and cause staining.



Correct positioning of base track above damp proof course

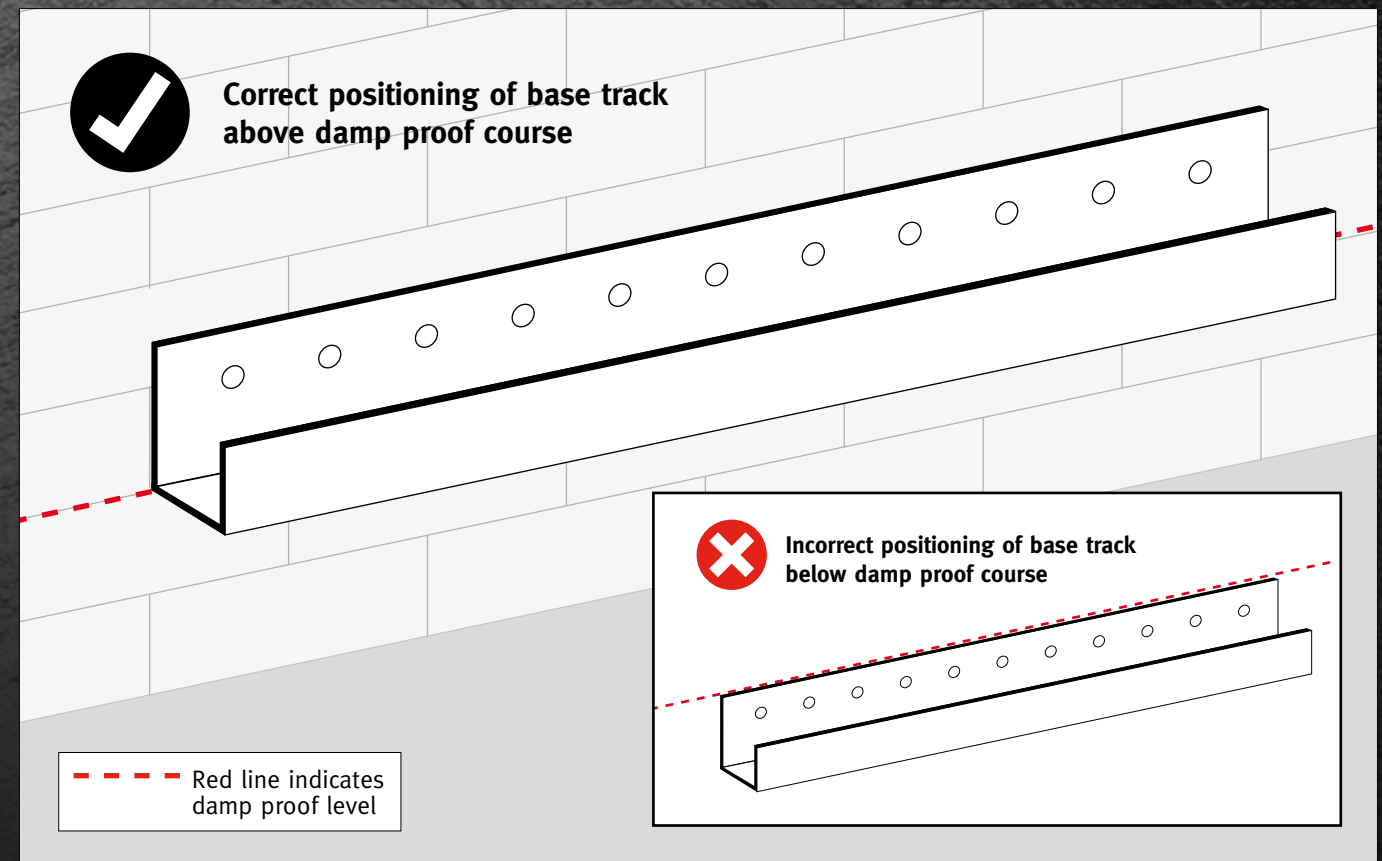

Red line indicates damp proof level

Base track positioning guide



Incorrect positioning of base track below damp proof course

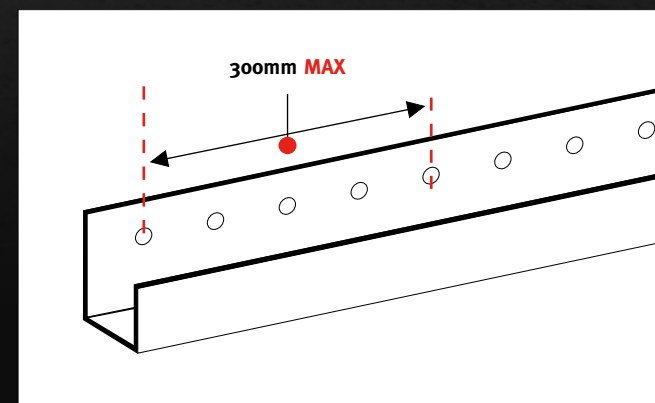
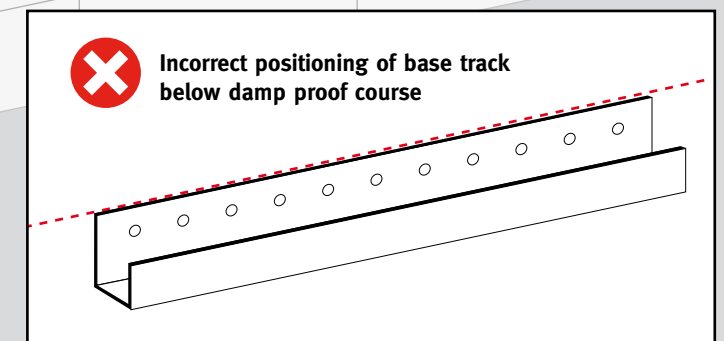

- Typical Base Track installation on masonry substrates requires the specified fixings to be used at a maximum distance of 300mm apart

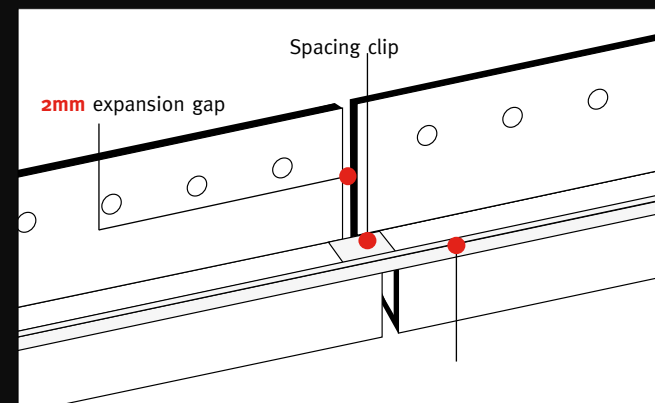

- Clip on plastic nose, placed over joints between each Base Track as a bridge to help reinforce and cover the joint

STEP ONE: APPLYING SYSTEM BASE TRACKS

Always carefully position the base track to the specification provided. Normally base tracks are applied along the top of the property damp proof course. Never bridge a property damp proof course with base track fixings.

Set out the base track along the property in the best configuration to avoid small cuts and always allow for a 2mm gap between each section to accommodate thermal expansion. Install as per the specification document and as appropriate for the substrate.

Typical base track installation on masonry substrates requires the specified fixing to be used at a maximum distance of 300mm apart. When using cut down lengths of base track always ensure each length has the correct number of fixings to support it appropriately.

Where the base track specified incorporates a clip on plastic nose this should be placed over joints between each base track as a bridge to help reinforce and cover the joint. Additionally spacing clips should be used to connect sections of base track.

In the eventuality that there are gaps between the substrate and the base track it will be necessary to pack out the substrate or bed in the base track to level the track and prevent any future system failure.

Avoid warping the base track by fixing into an uneven wall surface. Any gaps between the base track and the substrate should be completely filled and sealed firmly to the wall with a suitable sealant.

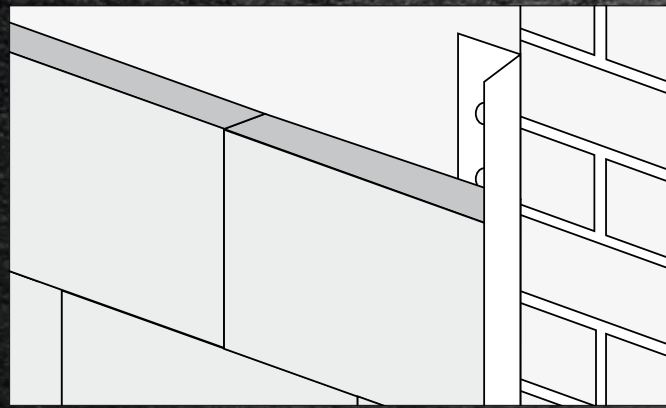

- Stop profiles run vertically, typically along a party wall boundary

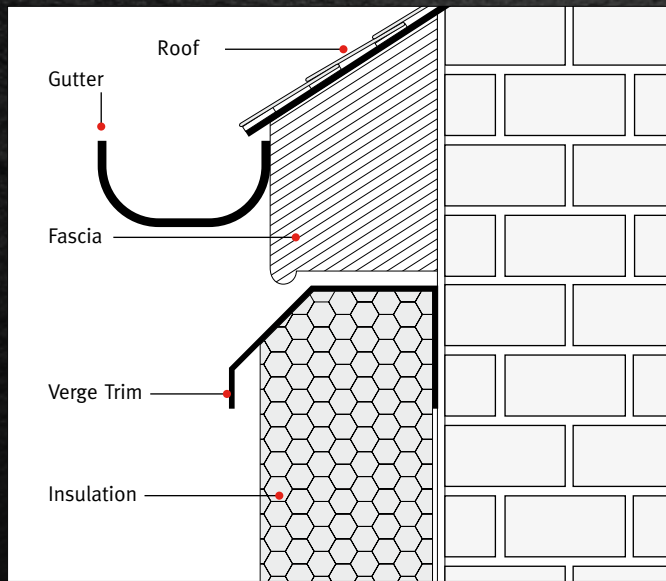

- Verge profiles are designed to protect the system on gable ends and roof lines when the system being applied will extend beyond them

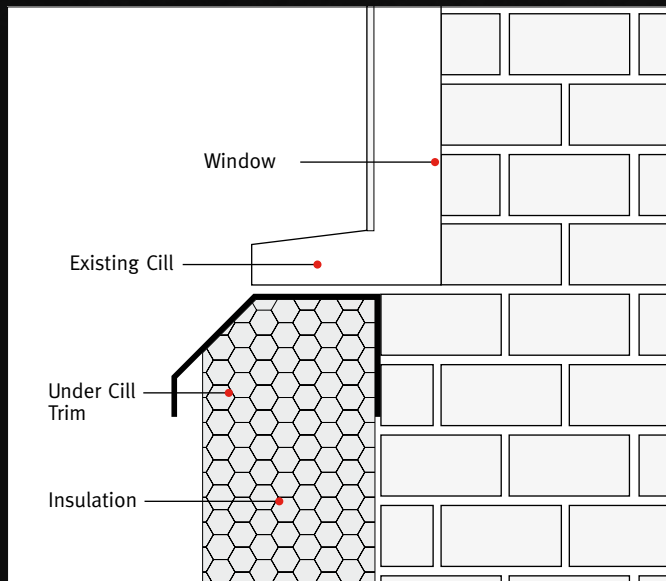

- Under-cill profiles should be used to extend existing window-cills when the system being applied will extend beyond them

STEP TWO :

Applying system stop, verge & under-cill profiles

In addition to base tracks there are typically three other main areas where profiles are required to protect an External Wall Insulation system.

STOP PROFILES ON VERTICAL BOUNDARIES

Stop Profiles are affixed vertically, typically along a party wall boundary or around features such as doors, windows or pipework that must remain exposed (i.e. gas feed).

VERGE PROFILES ON ROOF GABLE ENDS AND ROOF LINES

Verge profiles are designed to protect the system on gable ends and roof lines when the system being applied will extend beyond the depth of the existing gable bargeboard or roofline soffit.

WINDOW-CILL PROFILES

Under-cill profiles should be used in the same way as verge profiles-to extend existing window-cills when the system being applied will extend beyond them.

Set out the profile as per the project specification.

Protection from water ingress

System performance depends on the prevention of water ingress behind the render. When rendering up to any point on the wall where the system stops such as a stop bead, windows, doors, verges, cills etc. a soft joint should always be applied to ensure the render surface is completely sealed flush to the surface it meets. Soft joints can be formed using an appropriate compressible seal or a suitable low modulus silicone sealant.

STEP THREE :

Applying insulation panels

All insulation panels must be handled carefully and stored properly on a level, dry, surface and suitably protected against damage or prolonged wetting.

Each type of insulation has its own health & safety, storage and handling requirements so it is important to refer to the relevant datasheets for each product.

Typically all Johnstone's insulation panels are 1200mm long by 600mm high. Always fix insulation boards to walls from the base track upwards, starting from a corner and finishing at the roof line and always starting from a fixed edge.

Fix all boards with the long axis (1200mm) horizontal unless it is clearly stated otherwise in the specification.

The procedures detailed below must be followed:

- If the substrate is uneven or unstable it must be correctly prepared prior to the installation of any insulation panels.
- Do not use small sections of insulation panel. Never use a piece of insulation smaller than 250mm x 600mm.
- The joints between insulation panels should NOT be in alignment with prominent features such as window and doors as these become stress points on the system - corners around features should be covered with an 'L' shaped

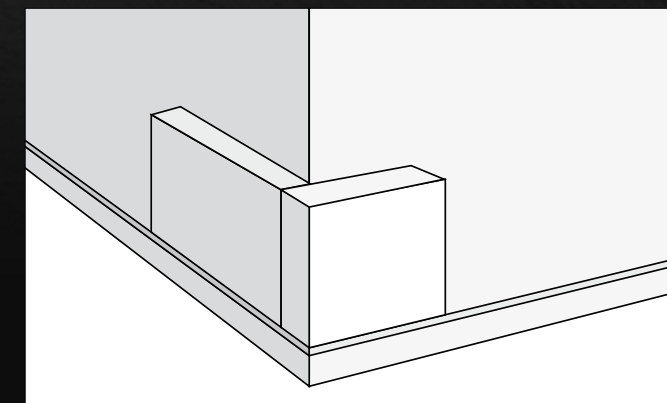

- Always fix insulation boards to walls from the base track upwards, starting from a corner

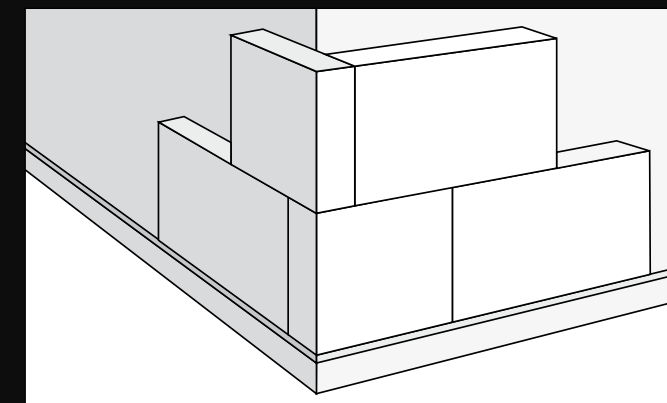

- Insulation Panels should always be butted seamlessly together to ensure no gaps exist between them. Take care to stagger joints at the corners of surfaces being covered

- Boards must be mounted to the substrate in an offset pattern (broken bond) with a minimum gap between the vertical edges (vertical offset) of 250mm.
- It is advisable to use a half board of insulation at the start of the application to allow the flexibility required to avoid using small pieces of insulation panel and to assist in applying panels correctly around feature stress points.
- Insulation panels must always be mounted level. Ensuring the base track is perfectly aligned is critical to this. Failure to start from a good horizontal base could result in future failure and create significant issues.
- Insulation panels should always be butted seamlessly together to ensure no gaps exist between them. This not only contributes to system stability but also to thermal performance.
- Where small gaps cannot be avoided they should never exceed 6mm and must be filled with a suitable PU foam to completely seal the gap (with any 'proud' pieces of foam cut flush to the insulation boards once it has set).
- Always carefully cut insulation panels to fit into place – attempting to force or hit them into place to create a close join will not work.
- Take care to stagger joints at the corners of surfaces being covered. It is possible to apply insulation panels to overhang corners and then straighten them post installation by cutting off the overhang, or to measure, mark, cut and fix insulation panels to the wall edge.
- Always ensure the outward surface of all insulation panels are completely flush prior to applying Johnstone's High Performance Render Basecoat.
- Ensure insulation panels are appropriately bedded and levelled, fill any gaps created by insulation anchors, cut away any protruding foam (after it has been allowed to cure) and remove any raised edges on insulation panel joints where possible. Failure to do so will impair the quality of the finish.
- Where insulation panels are required to go over bolts, brackets or battens that will be used to hold wall features such as satellite dishes and downpipes, insulation panels should be cut away to the desired thickness from the back face of the insulation panel to allow a neat fit over the protrusion. Insulation panels used to cover such protrusions should never be thinner than 30% of the original thickness of the insulation being applied. If in doubt refer to the specification or speak to your Technical Sales Manager.

Always attempt to plan and set out the surface to be panelled before starting application.

Where required, insulation panels should be bedded and levelled by applying either Johnstone's Stormshield High Performance Insulation Adhesive or Johnstone's Stormshield High Performance Basecoat to the back of the insulation panels.

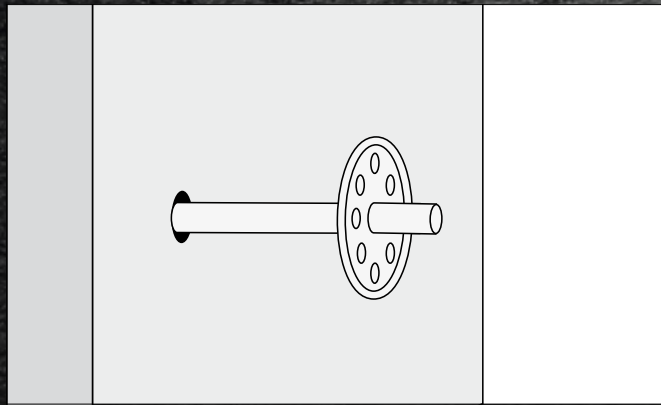

■ Insulation panel anchors

Fixing insulation panels

Please always refer to the specification to ensure the correct panel fixing method is followed. It is always advisable to fix insulation panels with both an adhesive and insulation anchors to achieve the most stable application.

In some cases it is possible to use only insulation panel anchors however this should only be done if a Technical Sales Manager has allowed this in the specification as it depends on building height, location, substrate suitability and the type and thickness of insulation being applied.

Using insulation panel adhesive

Carefully mix Johnstone's Stormshield Insulation Adhesive or Johnstone's Stormshield High Performance Basecoat (both products are suitable for use as an insulation panel adhesive) as per the product instructions.

Once mixed and ready, apply across the whole of the back of the insulation panels using a stainless steel trowel and then prepare 10x12mm ribs across the whole panel using a notched trowel.

Alternatively apply in dabs, ensuring that the dabs are evenly applied to the insulation panel and cover at **least 60%** of its surface. Dabs should not be more than **25mm thick** when the board has been applied to the substrate.

The insulation boards should be moved into position and pressed into place with a twisting and sliding action to achieve full adhesive to substrate transfer. Always ensure outer edges are closely butted and aligned to ensure minimal surface protrusions between panels and a level surface.

Whilst waiting for the adhesive to set insulation panel anchors can be applied to hold the panels in place.



After 24 hours in suitable conditions the adhesive should be set allowing the system application to continue.

Using insulation panel anchors

Please note that Johnstone's only specifies insulation panel anchors from a single partner supplier. All anchors are fully approved for use with Johnstone's systems and are backed up with comprehensive technical support. The specified anchor will be chosen for its performance in relation to the insulation material and the substrate.

Substrate pull tests may be required to ensure the correct anchor is used. The specified anchor must always be used as directed.

Insulation panel anchors are typically applied at 5 per panel unless otherwise specified.

In this typical configuration one fixing should be located in the centre of the board and one in each corner.

On panels that run to the corner or edge of building walls apply an additional 3rd fixing along the outside edge in the middle of the panel to improve strength and prevent possible wind shear.

Corner anchors should be approximately 150mm from the board edge on full insulation panels. **On smaller cut panels this can be reduced to a minimum of 75mm from the insulation panel edge.**

Always follow the application instructions for each type of fixing carefully. Refer to the product datasheet for additional information to that provided below.

Typically the anchors specified will be one of the following:

Hammer in: these anchors are designed to be fitted flush to the top surface of the insulation panel and the protruding pin hammered flush. Pushing the pin in creates the required expansion. These pins also feature the appropriate combination of components to ensure the prevention of thermal bridging.

Screw in: these anchors are designed to be fitted flush to the top surface of the insulation panel and the protruding screw driven flush to provide required expansion. These screws are more suitable for use on more friable and unstable substrates such as no-fines, where hammer fixings may be inappropriate. Again they also feature the appropriate combination of components to ensure the prevention of thermal bridging.

Fixing insulation panels into reveals

It is always advisable to ensure insulation is used on window and door reveals to ensure the thermal performance of the external wall insulation system. Wherever possible this insulation should be of the same thickness as the main wall insulation panels. However, this is not always viable - particularly on existing buildings where the window is fixed and is not to be replaced.

Where a thinner insulation material is necessary always use a minimum thickness of 20mm of the same material as that used on the main wall surfaces.

Use narrow strips of insulation to line the reveal, ensuring that they are a minimum 250mm long.

Reveal insulation sections should be fixed in one of two ways:

- By ensuring the main wall panels overlap the reveal by the depth of the reveal insulation being used and running the reveal insulation flush to it.
- Or by cutting the main wall board on the line of the existing reveal and then installing the reveal board to lap the exposed edge.

Reveal insulation panels should be fixed with Johnstone's Stormshield Insulation Adhesive or High Performance Basecoat and insulation panel anchors at a maximum distance of 300mm apart following the same process at that specified for fixing insulation panels.

Please note that a different sized insulation anchor may be required if the insulation being used is of a different thickness to the main wall panels.

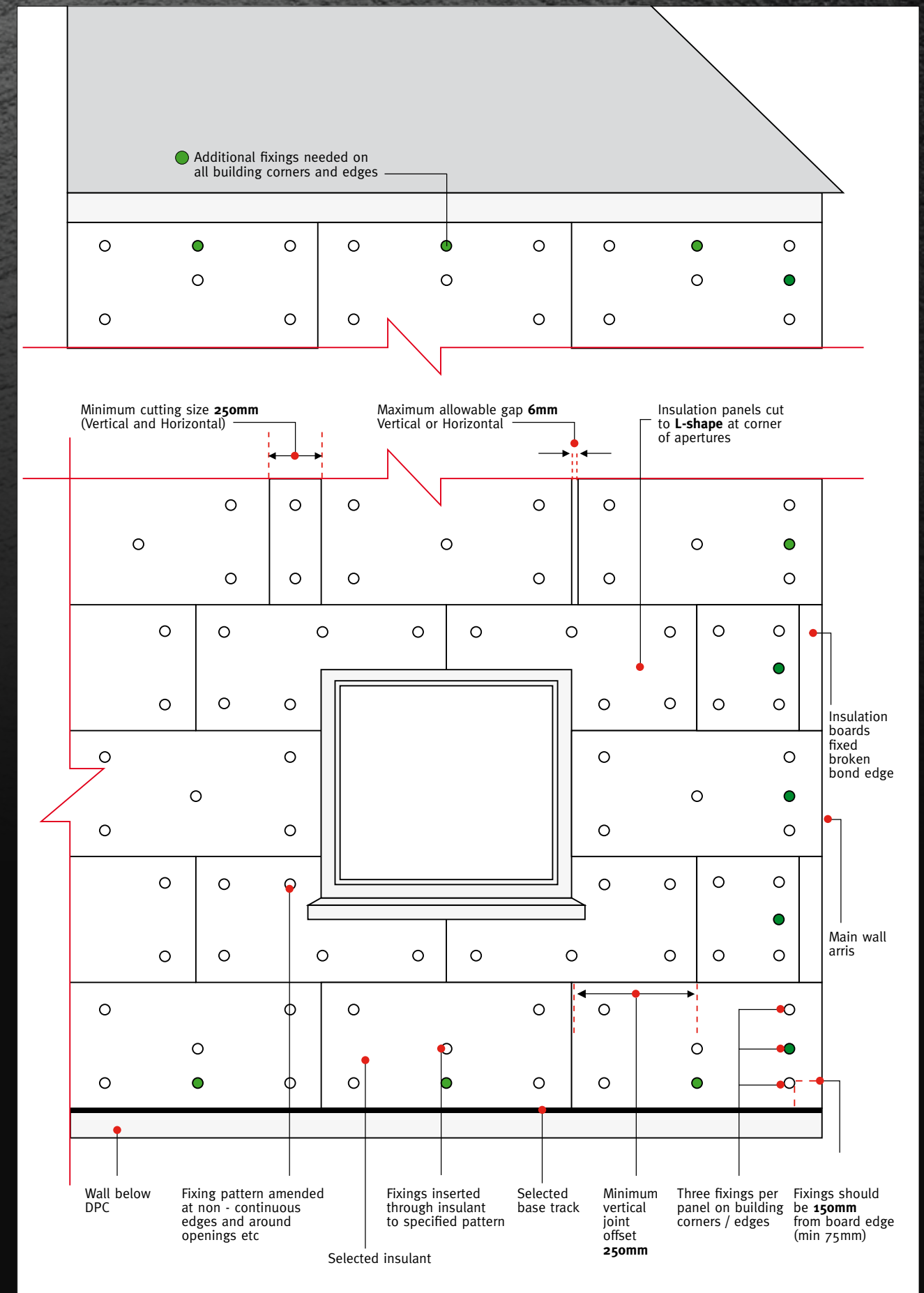

■ Insulation panel pattern guide

STEP FOUR: APPLYING RENDER BEADS

Johnstone's Stormshield offer a broad assortment of render only beads for use with our external wall insulation systems.

All beads and components are supplied to our exact specifications by a partner supplier and specified for use to achieve the highest quality finish.

Johnstone's provide a wide range of surface, stop, movement, drip and corner beads as standard and will also source any additional specific components to meet the needs of the job as required.

- All surface mounted render beads should be carefully cut to the required size and set to one side prior to application.
- Following this a thin coat of Johnstone's Stormshield High Performance Basecoat should be applied to the area the bead is being applied and the bead bedded in.
- Allow to set prior to the main basecoat layer being applied.
- Alternatively, hold profiles in place with plastic plug fixings.
- Make sure all render bead joints are perfectly aligned and avoid knocking or moving the beads during the application of the basecoat layer.
- Check alignment before the bedding has set with a suitable plumb, level and by eye.

Surface beads

Horizontal or vertical surface beads can be used as a means of dividing the wall surface into sections for different colours, textures, as a decorative highlight or as a means to create a 'break' to allow work to be completed in sections.

If a surface bead with a detachable plastic nose is being used always make sure the nose bridges joints between two pieces of beading.

Movement beads

Movement beads are used to express or detail joints that are in the substrate, they can also be used to form day joints. These can be used to break up large panel sizes and used to indicate the boundary lines of attached properties.

Never cover building expansion joints with insulation.

Corner beads

These beads are used mainly to facilitate the formation of a straight arris at main wall corners and in reveals. Angle beads are provided to allow the edge of the corner bead to grin through the finished render to allow for a clean and neat corner profile. These are available with or without a detachable plastic nose. If a corner bead with a detachable plastic nose is being used always make sure the nose bridges joints between two pieces of beading.

Mesh wing corner beads

In situations where corners or reveals are to be formed without a protruding edge Johnstone's supply a mesh winged corner bead. The fibreglass mesh wing allows for these beads to be comprehensively bedded into the system with Johnstone's Stormshield High Performance Basecoat to allow for maximum strength on system stress points. Always ensure that the mesh is fully covered by basecoat and is not visible (no 'grin through') and that the main mesh or scrim cloth wall covering overlaps the corner bead mesh.

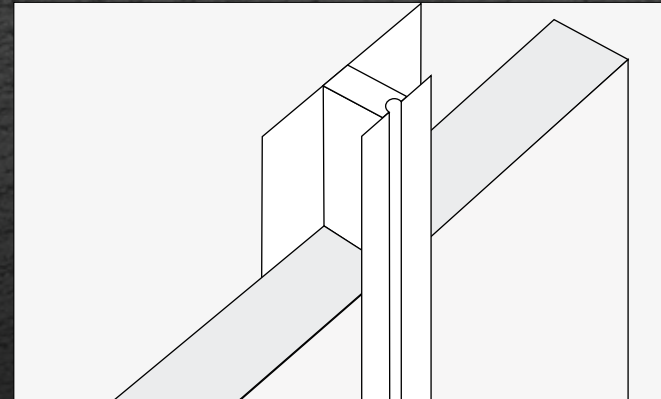

■ Movement bead

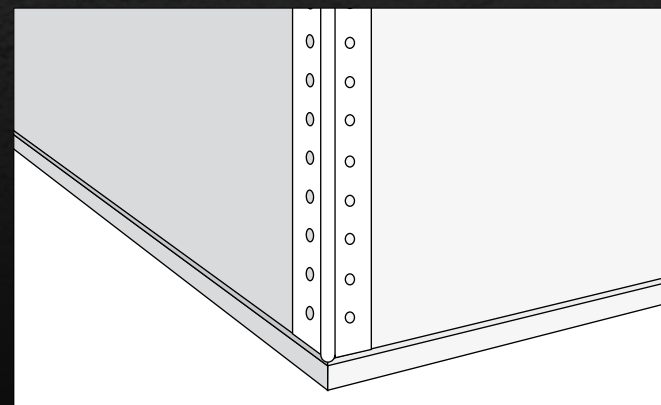

■ Protruding angle corner bead

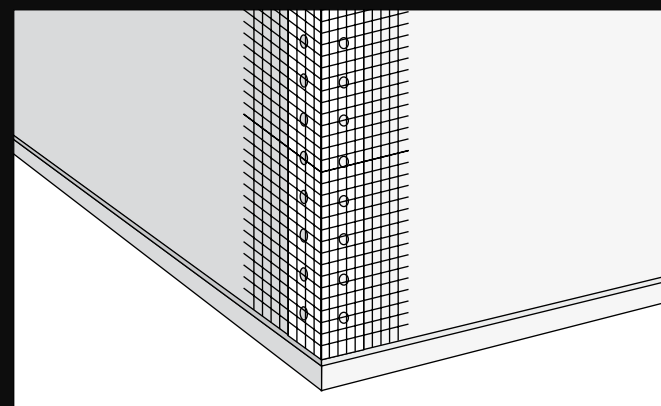

■ Mesh wing corner bead

STEP FIVE: APPLYING BASECOAT & MESH/SCRIM CLOTH

Initial basecoat layer

Prepare Johnstone's Stormshield Basecoat as per the product instructions and apply to fully fixed and prepared insulation panels using a **stainless steel float to a depth of c.3-4mm**.

When applied, use a notched trowel to create horizontal lines in the basecoat prior to the application of Johnstone's Stormshield render reinforcing mesh cloth (scrim cloth).

Applying mesh/scrim cloth

The mesh should be applied to the wet basecoat using the roll vertically. It is easier to apply if used in manageable sized pieces rather than trying to roll large sections down a section of wall. Cut the fibreglass mesh with scissors or a sharp knife and handle carefully in accordance with the product datasheet. Always ensure that any joints between pieces of fibreglass mesh cloth overlap each other by a minimum of 100mm.

Bed the fibreglass mesh firmly into the basecoat using a stainless steel float, always working from the top of the piece downwards.

Take care to form corners tightly to avoid the fibreglass mesh from bulging out and pulling away from the basecoat. Offcuts can be used as reinforcing pieces (see later).

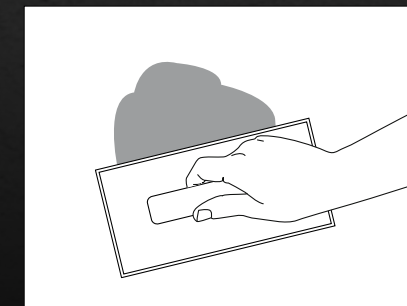

■ Apply basecoat to fully prepared insulation panels using a stainless steel float to a depth of c.3-4mm

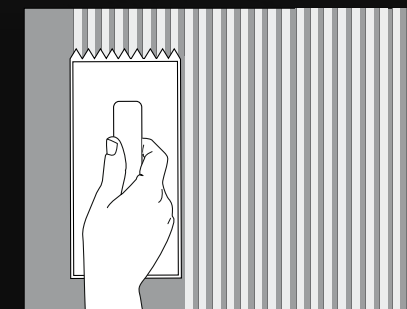

■ Use a notched trowel to create vertical lines in the basecoat prior to the application

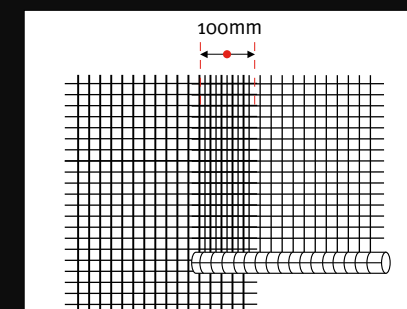

■ Ensure mesh overlaps by 100mm

Using heavy duty mesh/scrim cloth

Where a high impact heavy-duty mesh cloth is required, this must be applied and bedded into the first layer of wet basecoat in the same way as the standard mesh, however **DO NOT** overlap the edges of pieces - but them closely together to form a continuous layer.

When the first pass of basecoat has set, apply a second pass of basecoat and bed standard fibreglass mesh into this layer covering the heavy duty mesh. No traces of the fibreglass mesh should be visible through the second layer.

Reinforcing stress points/ corners

All corners to reveals constitute significant stress points and must be reinforced with an additional patch of Johnstone's Stormshield reinforcing mesh. These patches **should be cut into 200-300mm squares or rectangles** and placed on all corners diagonally to create lateral strength in the system and form a reinforcing patch.

Reinforcing patches must be applied in addition to the main application of reinforcing mesh and should be applied after the main mesh has been bedded into the first pass of basecoat.

Offcuts and pieces of mesh cloth left over from the main application can be used as long as they are suitably sized, clean and undamaged.

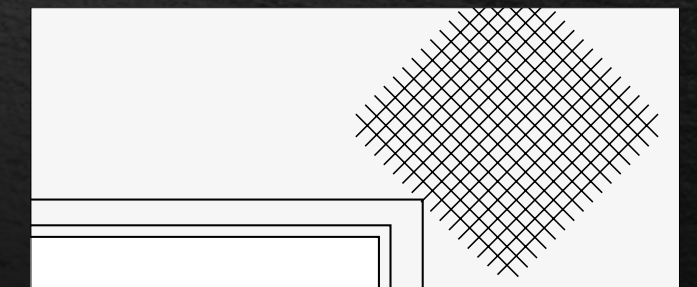

■ Reinforcing mesh patches should be cut into **200-300mm squares or rectangles** and applied to all stress points.

Final basecoat layer

Once this initial set of basecoat and mesh has taken up apply a second coat of Johnstone's High Performance Basecoat **to a depth of c. 3mm** over the first to form a 'sandwich' for the fibreglass mesh.

The total thickness of the basecoat layer should be 6mm and no traces of the fibreglass mesh should be visible through the second layer.

Exposed render beads should be cleaned down immediately following application with a damp paint brush or cloth. Avoid allowing the basecoat to set on exposed surfaces as it can be difficult to remove and can cause staining.

Finish the basecoat in one of two ways

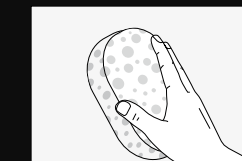

- If the chosen finish is Johnstone's Stormshield Silicone Render prepare the basecoat with a suitable sponge float to ensure a lightly textured flat surface.

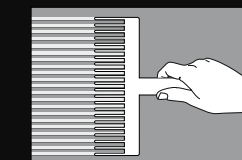

- If Johnstone's Stormshield Dash or Brick Effect Render is being applied lightly scratch the basecoat before it sets with a spiked float or comb to provide a key.



Allow the Basecoat to fully set and cure before applying the specified Johnstone's Stormshield finish.

STEP SIX: APPLYING YOUR SELECTED JOHNSTONE'S STORMSHIELD RENDER FINISH

After the Johnstone's Stormshield High Performance Basecoat has been applied, finished and allowed to cure, finishing coats can be applied.

General advice for applying a high quality, consistent finish

When applying Johnstone's Stormshield render finishes it is always advisable to apply the product across a single continuous surface maintaining a constant wet edge. Failure to apply across a single elevation in one application may result in visible differences in the finish.

Always therefore ensure you have suitable access and enough product available to complete a single elevation or to a natural or installed break to avoid unsightly imperfections in the finish.

Movement joints, stop beads and elevation edges are natural points to render to, however decorative render beads can also be utilised to break large surface areas and form natural points to render to in single applications.

Carefully consider the suitability of the access equipment being used – there should be space between any scaffold and the wall to enable a continuous wet edge of material to be maintained across the complete elevation.

Johnstone's Stormshield Silicone Renders

Because the basecoat contains cement a protective layer of silicone render primer must be applied prior to the application of the silicone render.

The primer has a similar consistency to paint and as such can be applied by brush, roller or spray depending on the size of the job.

Johnstone's Stormshield silicone primers are available in a wide range of colours to complement the finished silicone render to improve colour depth and to ensure that any 'grin through' from the silicone render does not reveal a different colour.

It is important to ensure the basecoat is completely covered by primer and that it is allowed to fully dry before the application of silicone render.

Mix the product thoroughly before application, ensure products used on the same elevation are from the same batch and if possible batch multiple containers together to ensure colour consistency across the surface.

Exposed render beads should be cleaned down immediately following application.

Once the silicone primer has been applied and allowed to dry for at least 12 hours Johnstone's Stormshield Silicone Render can be applied.

Mix the product thoroughly before application and when working on a continuous surface always mix multiple containers together to ensure consistency of colour.

Apply the render by stainless steel float to the thickness of the chosen silicone render aggregate, for example on a 1.5mm aggregate silicone render will be applied to the depth of 1.5mm.

Once the render has been applied finish with a plastic float working the material in small circular motions to remove excess material and create a natural random finish.

Different tools as well as different application and finishing methods will create different finishes - always agree an acceptable finished appearance on a sample panel with the client before proceeding on a large scale.

To prevent day joints apply the finish continuously to the surfaces, 'wet on wet' and on very large areas it is advisable to render to a natural break.

Weather conditions for applying and drying Silicone Renders are particularly important. Avoid application in conditions of high humidity, wet or cold conditions or if such conditions are forecast for the following 24 hours after application.



- Always apply silicone primer and render to a sponge finished basecoat

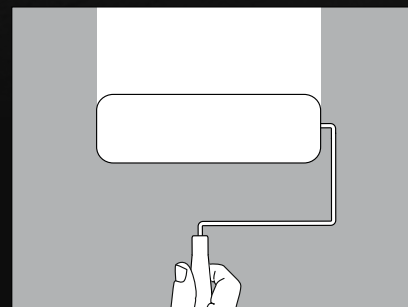

- The primer has a similar consistency to paint and as such can be applied by brush, roller or spray depending on the size of the job

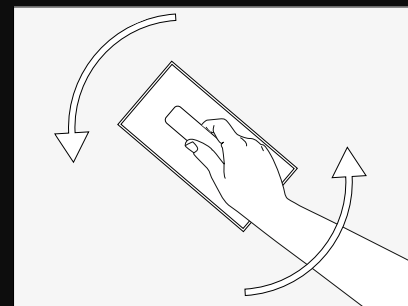

- Work the silicone render in small circular motions to remove excess material and create a natural random finish

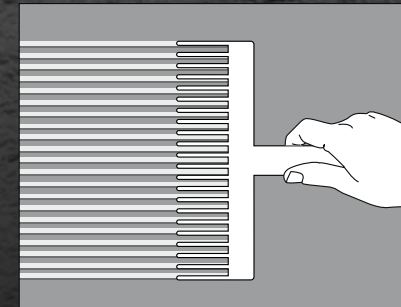

- Ensure that the Stormshield basecoat has been lightly combed

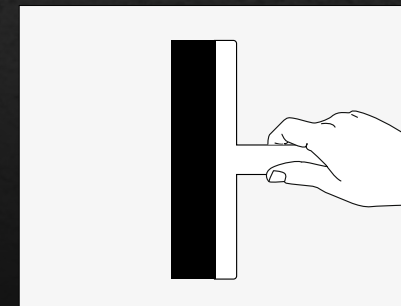

- Level Dash Receiver before applying aggregate

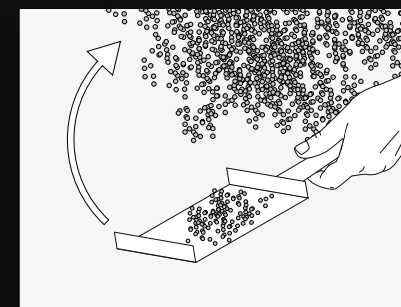

- Dash aggregate must be evenly applied to Dash Receiver of correct consistency

Johnstone's Stormshield Dash Finish

Johnstone's Stormshield Dash Receiver is available in a wide range of factory mixed colours in 25kg sacks. The product can be mixed and applied directly onto the Johnstone's Stormshield Basecoat (there is no need to use a primer).

- Ensure that the Stormshield Basecoat has been lightly combed and is ready to receive Stormshield Dash Receiver Render.

Stormshield High Performance Dash Receiver:

- Mix the powder by adding it to clean water ensuring that all equipment and accessories are clean and free of contaminating render and mix to the specified consistency.
- Apply to the already keyed Stormshield Basecoat to a depth of 6mm, trying to achieve an even coat - straight edges and spatulas may help with this process.
- Use only clean, properly graded aggregates specified by Johnstone's. All Stormshield aggregates are washed and bagged before delivery to site.
- Aggregates should be damp before dashing onto Dash Receiver.
- Aggregates droppings can only be re-used if collected on a proper tray or sheet material, and thoroughly washed in running water over a sieve or screen.
- Dashing must be evenly applied to Dash Receiver of correct consistency. Care must be taken to avoid lift marks or unsightly thickening at beads and arrises.
- Bead nosings must be cleaned down directly following dashing application.
- Care must be taken to maintain a wet edge particularly in warm weather.
- A thicker coat of Dash Receiver may be necessary when using a larger aggregate size to ensure it fully beds into the Dash Receiver.

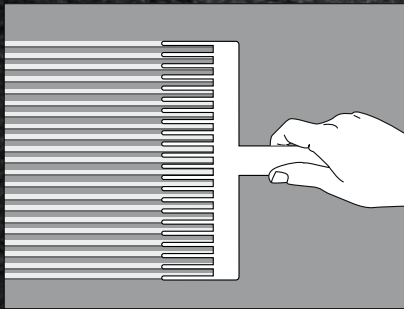

- Ensure that the Stormshield Basecoat has been lightly combed

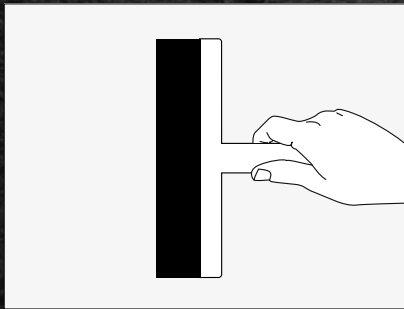

- Carefully level Brick Effect Render

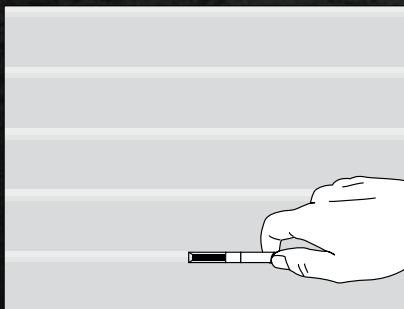

- Cut horizontal lines first

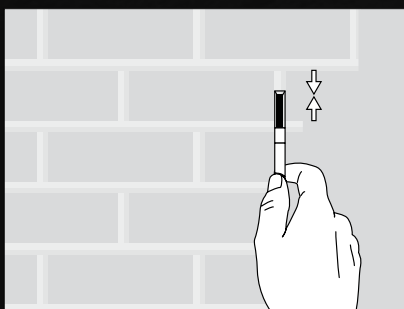

- Cut verticals **TIP** Always cut inwards from corners to avoid broken edges

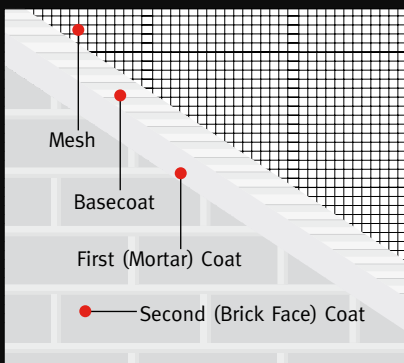

- Mesh
- Basecoat
- First (Mortar) Coat
- Second (Brick Face) Coat

Johnstone's Stormshield Brick Effect Render

Johnstone's Stormshield Brick Effect Render is available in a wide range of factory mixed colours in 25kg sacks. The product can be mixed and applied directly onto the Johnstone's Stormshield Basecoat (there is no need to use a primer).

- Ensure that the Stormshield Basecoat has been lightly combed and is ready to receive Stormshield Brick Effect Render.

Stormshield Brick Effect Render: First (mortar) Coat

- Mix the chosen mortar colour by adding the powder to clean water and leave to stand for 5mins before remixing, to ensure no dry powder remains. Apply to the Stormshield Basecoat to a thickness of 5-6mm in a flat, even coat.

- Take care not to over-trowel the material and ensure the whole elevation is level and even.

Stormshield Brick Effect Render: Second (brick face) Coat

- Mix the chosen brick face colour by adding the powder to clean water and leave to stand for 5mins before remixing, to ensure no dry powder remains.

- Wait until the first (mortar) coat has 'firmed-up', apply the second brick face coat to a thickness of 2-3mm in a flat, even coat.

- The recommended method of creating a brick effect is with a soft bristle brush directly after application.

Do not over work the render or add water to achieve a pattern as this may cause a colour and/or a surface tension problem later on.

Leave the second (brick face) coat to firm up before setting out the surface to the desired design or pattern with the chosen brick face coat. Mark out the horizontal lines first.

- Cut out the horizontal joints using a spirit level and a cutter. Do not cut too deep.

- Mark and cut out the vertical lines, again taking care not to cut too deep or damage the face coat.

- After all joints have been formed, and when the surface is partially cured, (hard but not fully set), remove all traces of cut out material by brushing with a soft bristled brush.

- Add no other materials unless directed.

Constraints

- Floating the brick face with a sponge, trowel or float to a smooth tight finish may have an effect on both colour consistency and product durability, and is therefore not recommended.

- Cutting out will take place after the first coat has formed a skin, and experience and climatic conditions will dictate the moment at which to commence.

- Proceed methodically rather than rushing and making mistakes which will be visible and time consuming to rectify.

- Do no cut too early as this will produce torn edges in the joints.

- Take particular care at corners.

- Keep cutting tools clean.

- Ensure the surface is hard enough before removing the scrapings. If done too early, there is a risk of damage to the surface.

SYSTEM DETAILS

Detail Section: Main Wall

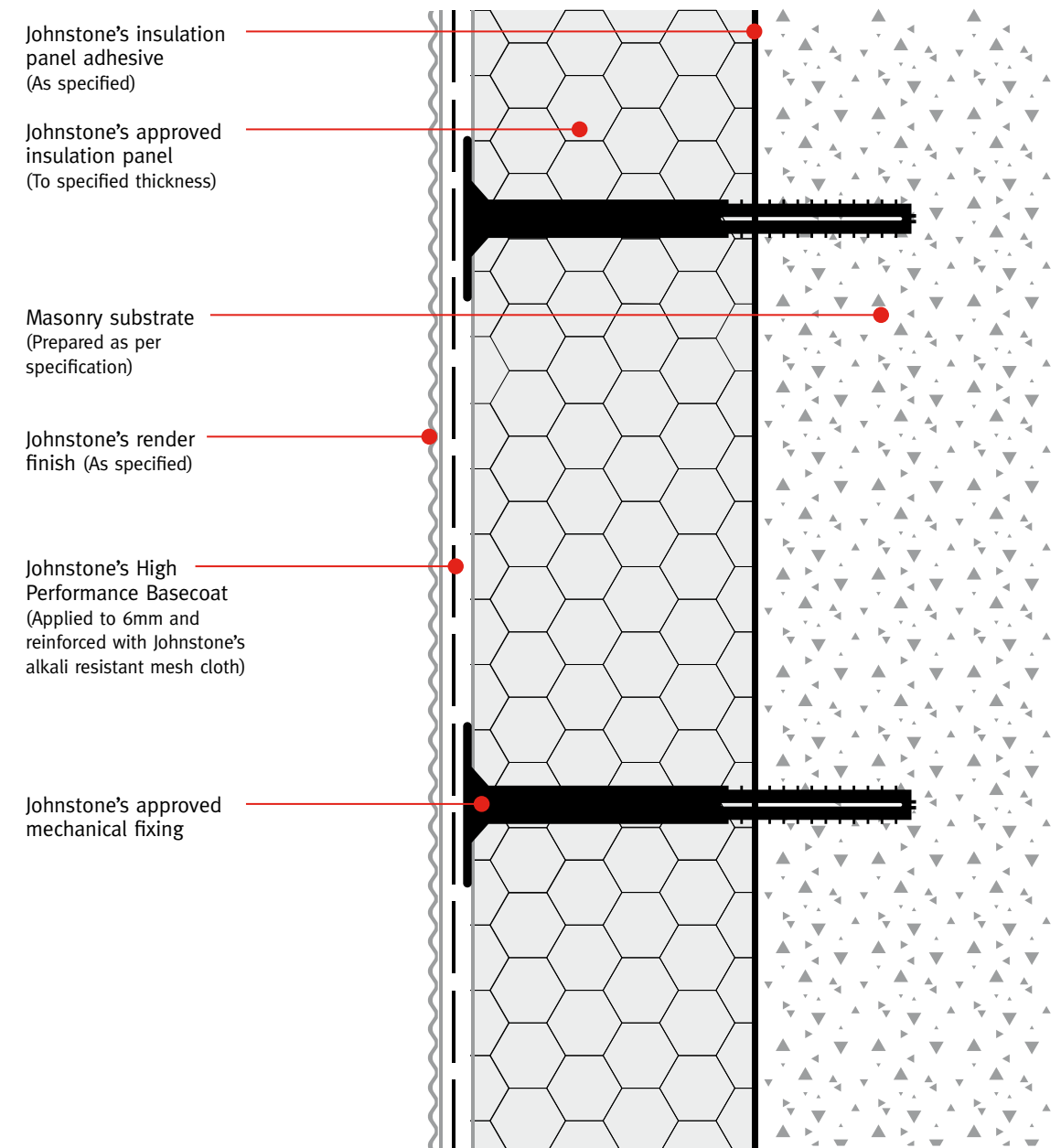

Johnstone's insulation panel adhesive (As specified)

Johnstone's approved insulation panel (To specified thickness)

Masonry substrate (Prepared as per specification)

Johnstone's render finish (As specified)

Johnstone's High Performance Basecoat (Applied to 6mm and reinforced with Johnstone's alkali resistant mesh cloth)

Johnstone's approved mechanical fixing

DRAWING: Standard Detail | DATE: NOV 2013 | REF: JS 1 | NO: 1

Detail Section: Base Track

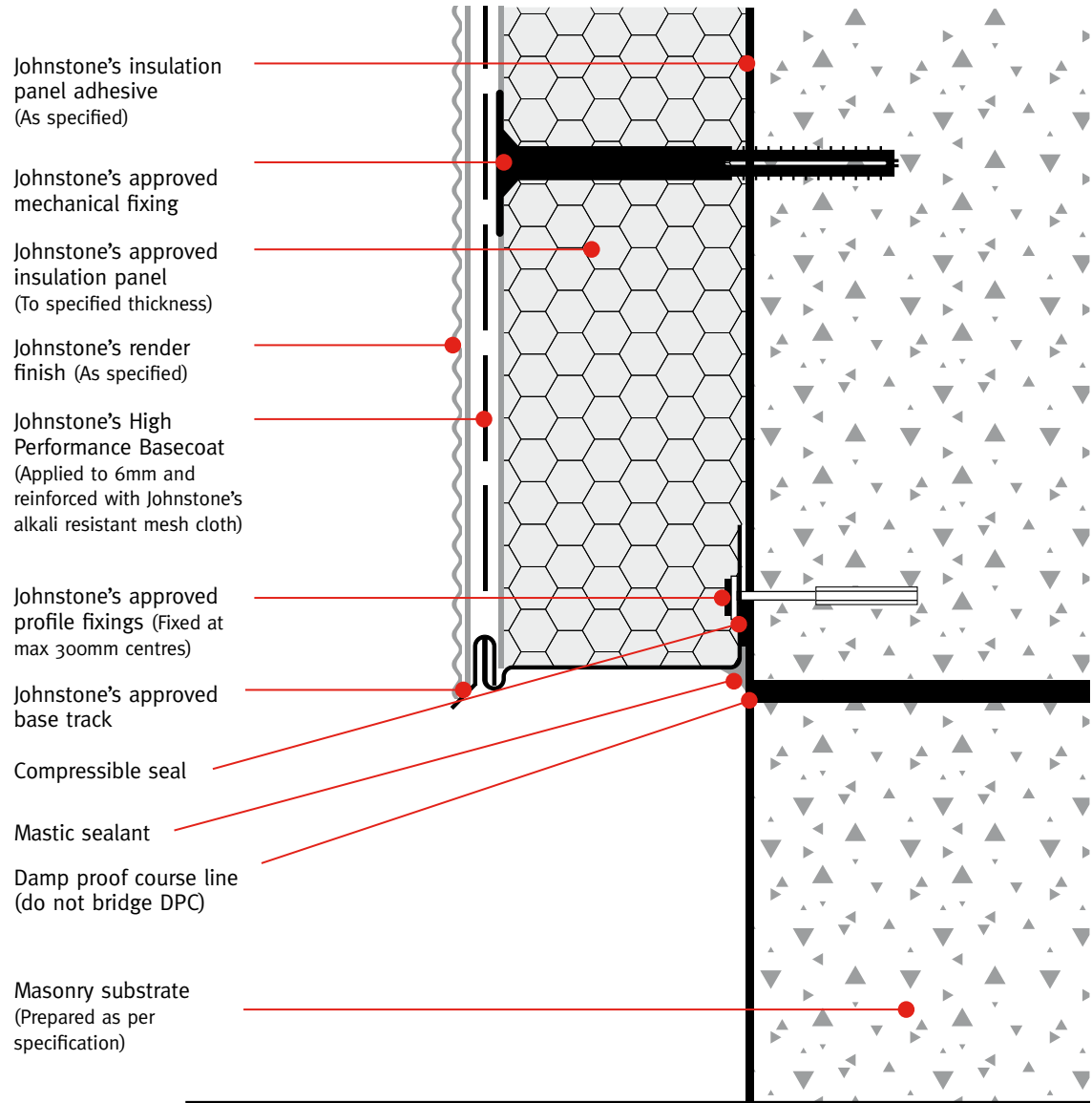

PAS 2030
Performance Indicator

✓	■	■
Standard	Improved	Excellent

DRAWING: Standard Detail | DATE: NOV 2013 | REF: JS 2 | NO: 2

Detail Section: External Corner

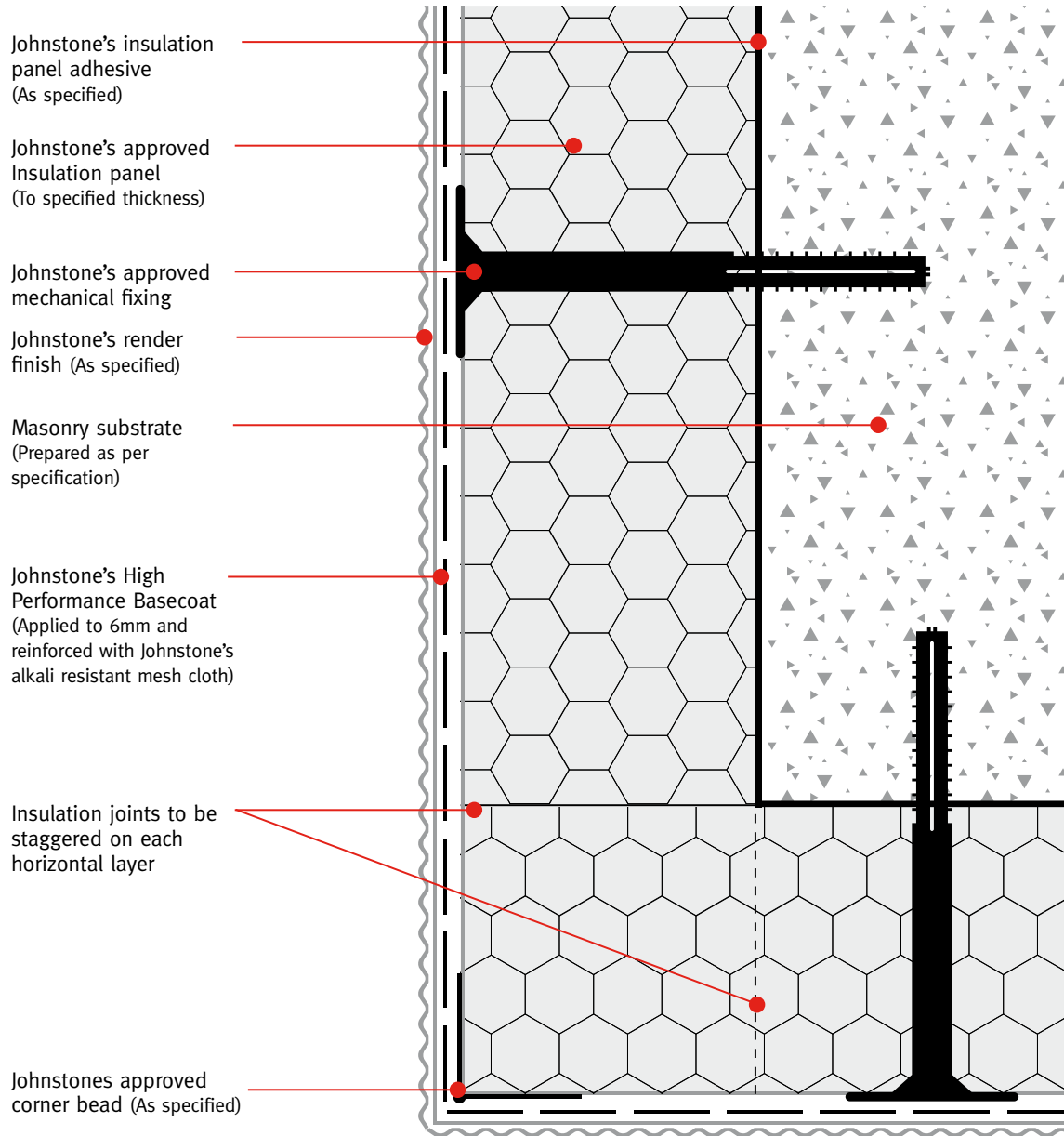

DRAWING: Standard Detail | DATE: NOV 2013 | REF: JS 3 | NO: 3

Detail Section: Internal Corner

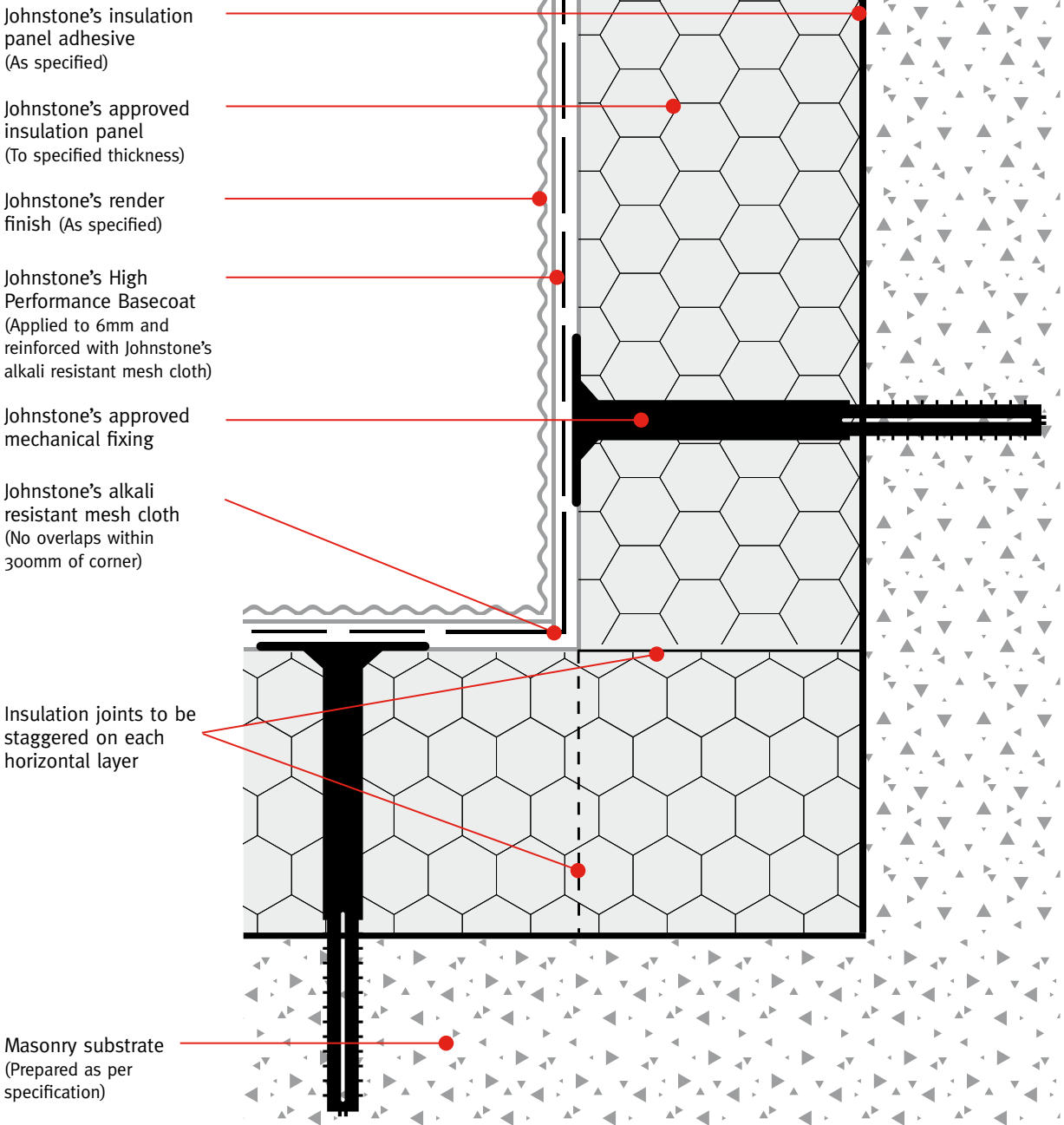

DRAWING: Standard Detail | DATE: NOV 2013 | REF: JS 4 | NO: 4

Detail Section: Existing Cill

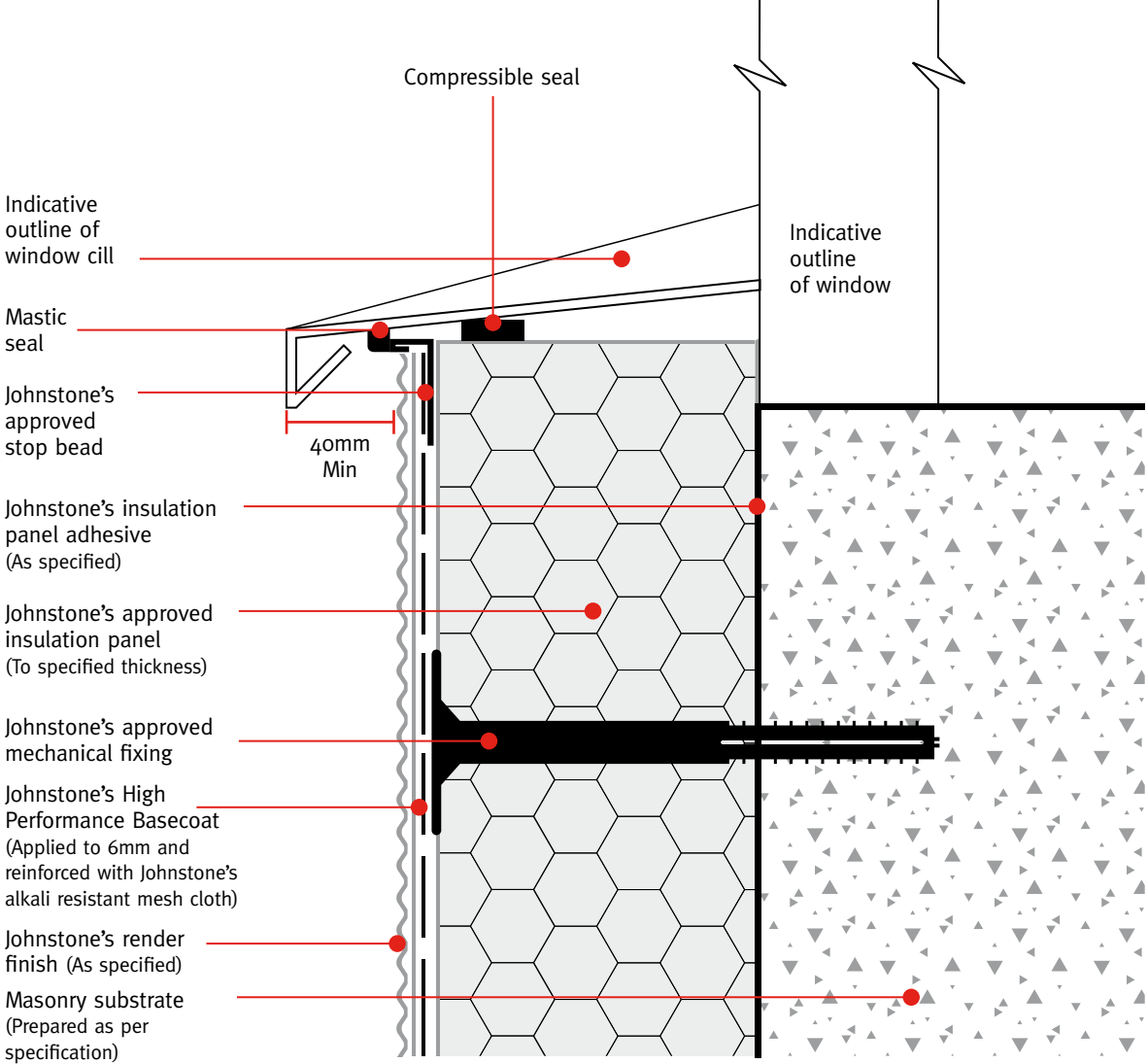

DRAWING: Standard Detail | DATE: NOV 2013 | REF: JS 5 | NO: 5

Detail Section: Undercill

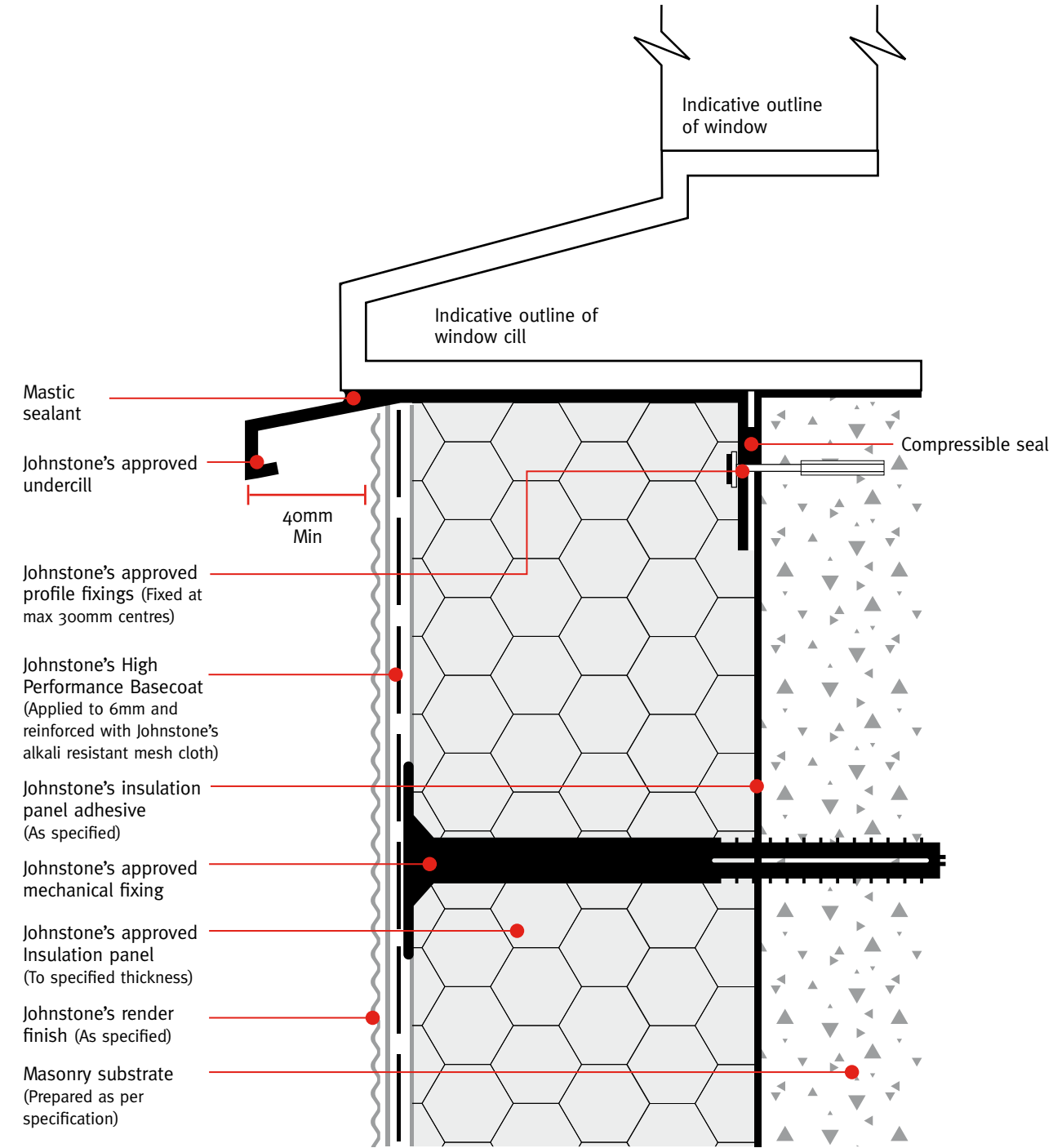

DRAWING: Standard Detail | **DATE:** NOV 2013 | **REF:** JS 6 | **NO:** 6

Detail Section: Overcill

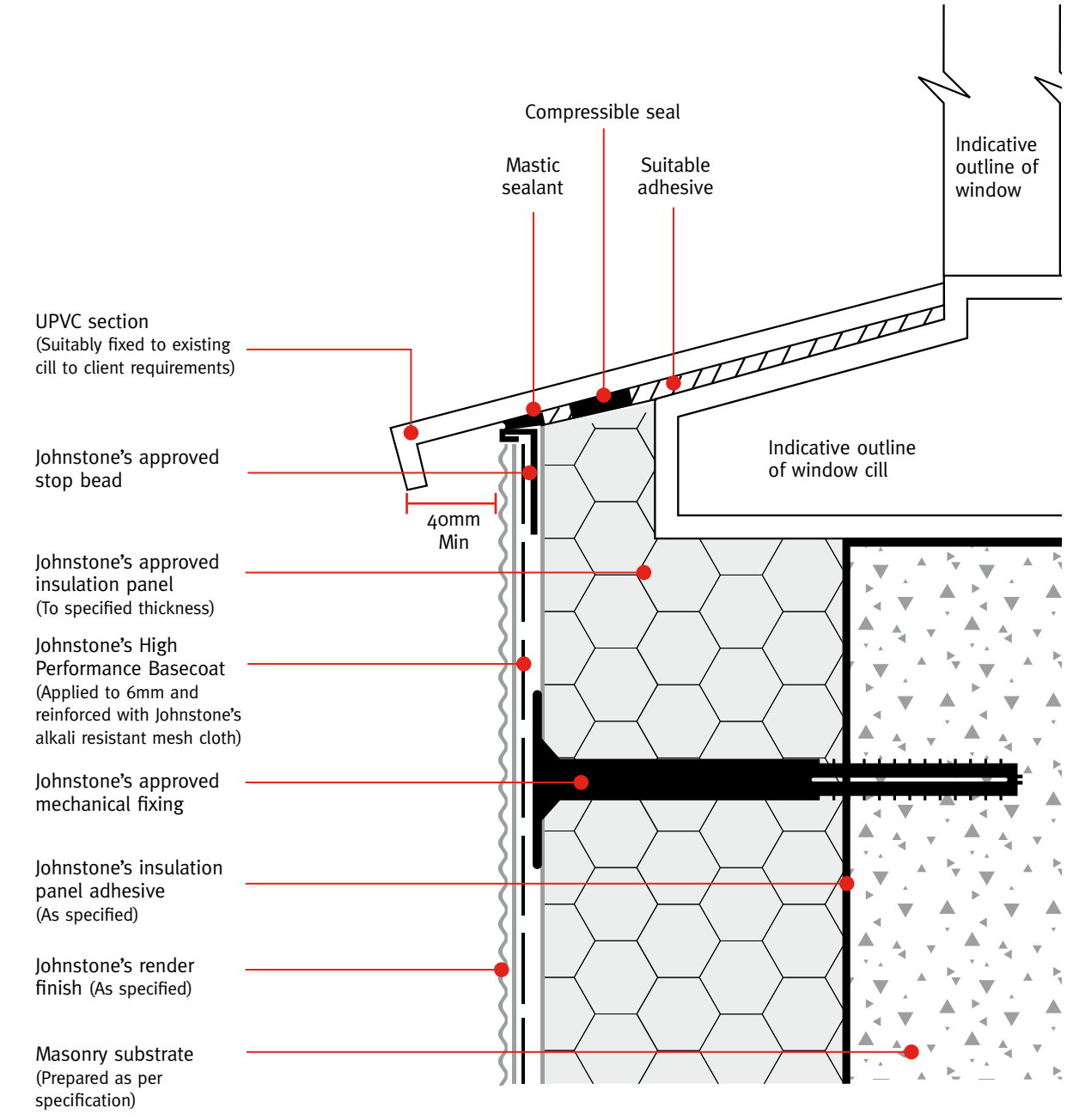

DRAWING: Standard Detail | **DATE:** NOV 2013 | **REF:** JS 7 | **NO:** 7

Detail Section: Reveal Detail 1 (Insulating into reveals)

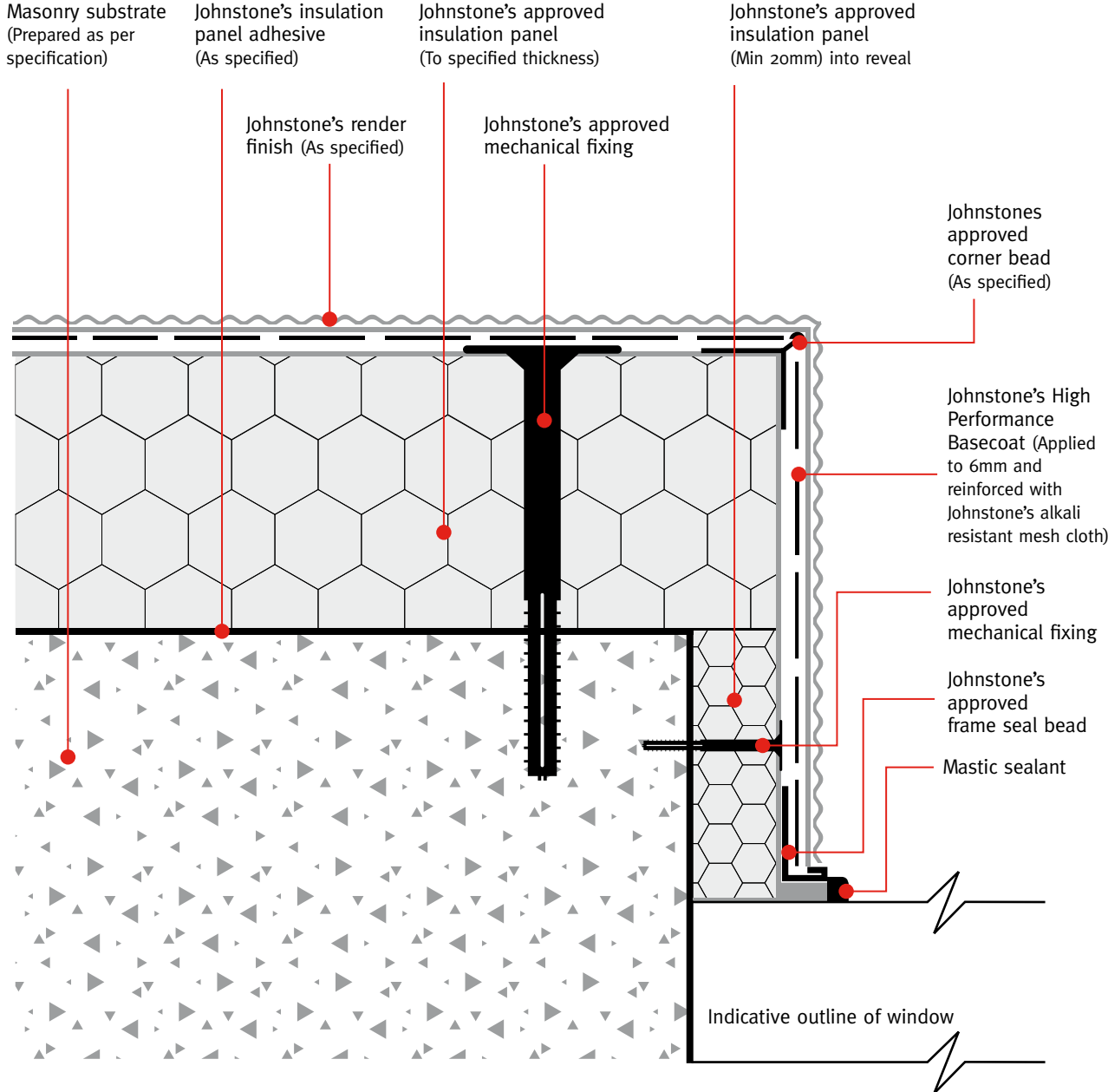

PAS 2030
Performance Indicator

		✓
Standard	Improved	Excellent

DRAWING: Standard Detail | DATE: NOV 2013 | REF: JS 8 | NO: 8

Detail Section: Reveal Detail 2 (Rendering into reveals)

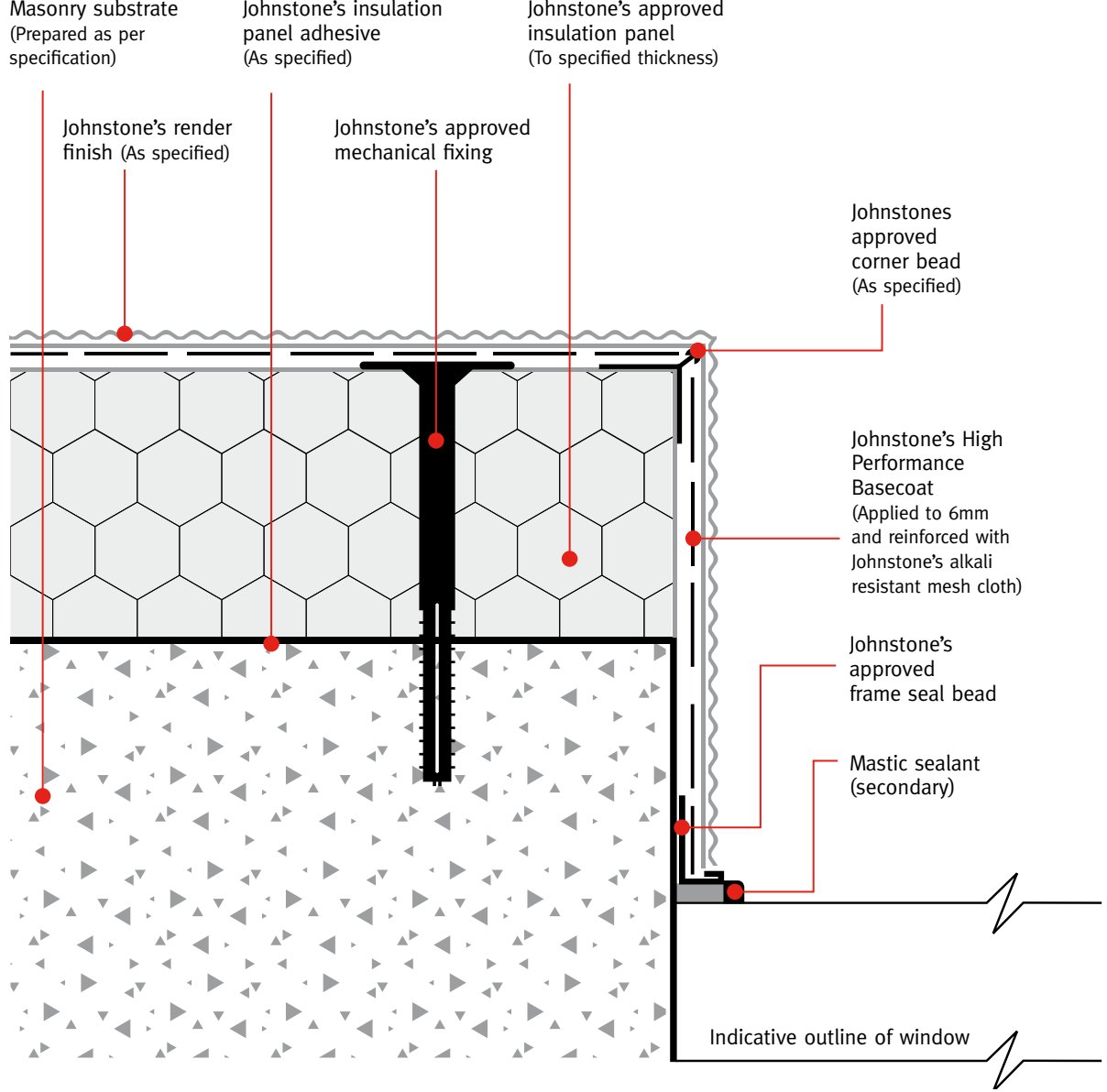

PAS 2030
Performance Indicator

✓		
Standard	Improved	Excellent

DRAWING: Standard Detail | DATE: NOV 2013 | REF: JS 9 | NO: 9

Detail Section: Reveal Detail 3 (No masonry reveal)

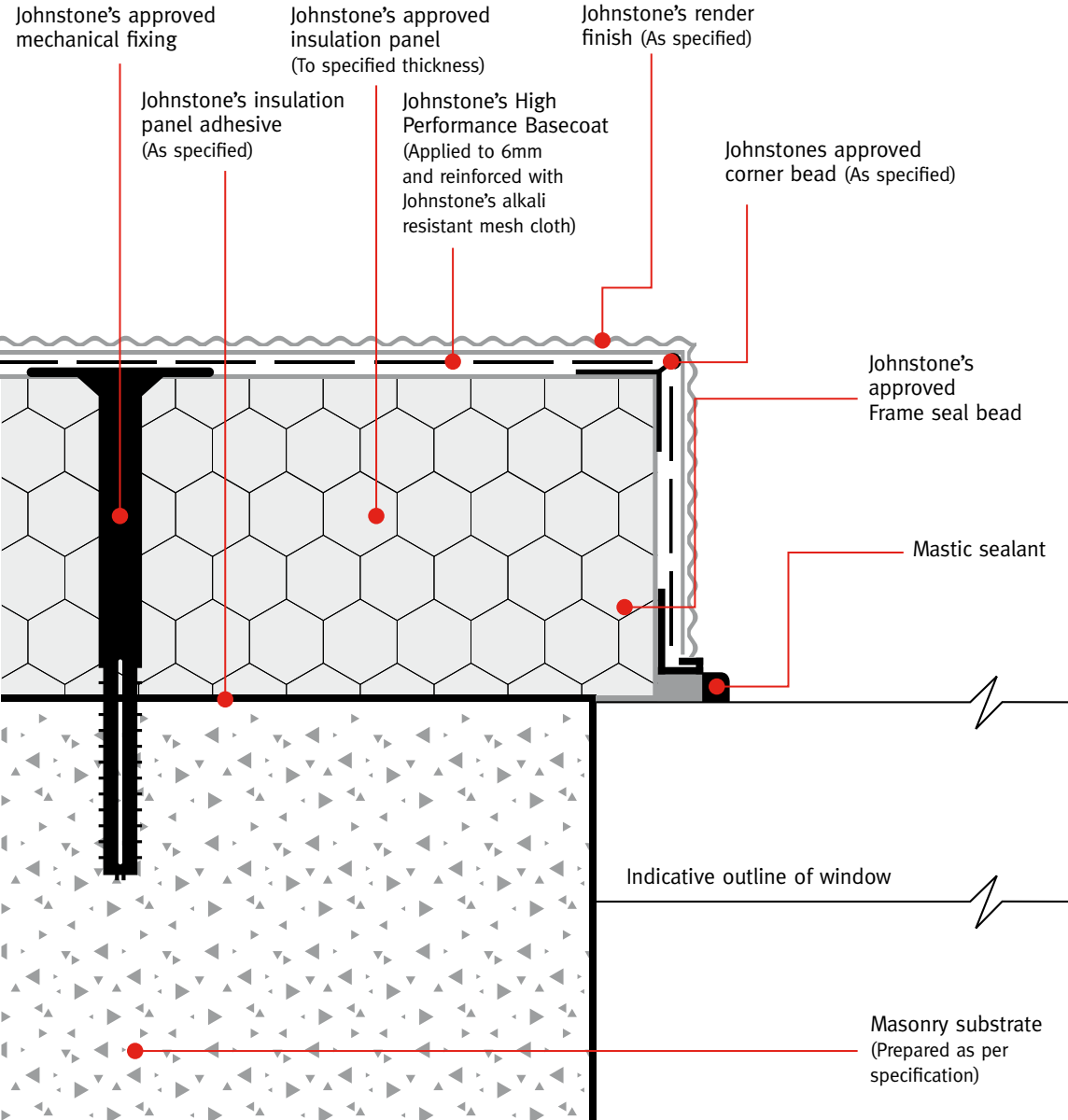

PAS 2030
Performance Indicator

		✓
Standard	Improved	Excellent

DRAWING: Standard Detail | DATE: NOV 2013 | REF: JS 10 | NO: 10

Detail Section: Vertical Stop 1 (Render to vertical stop)

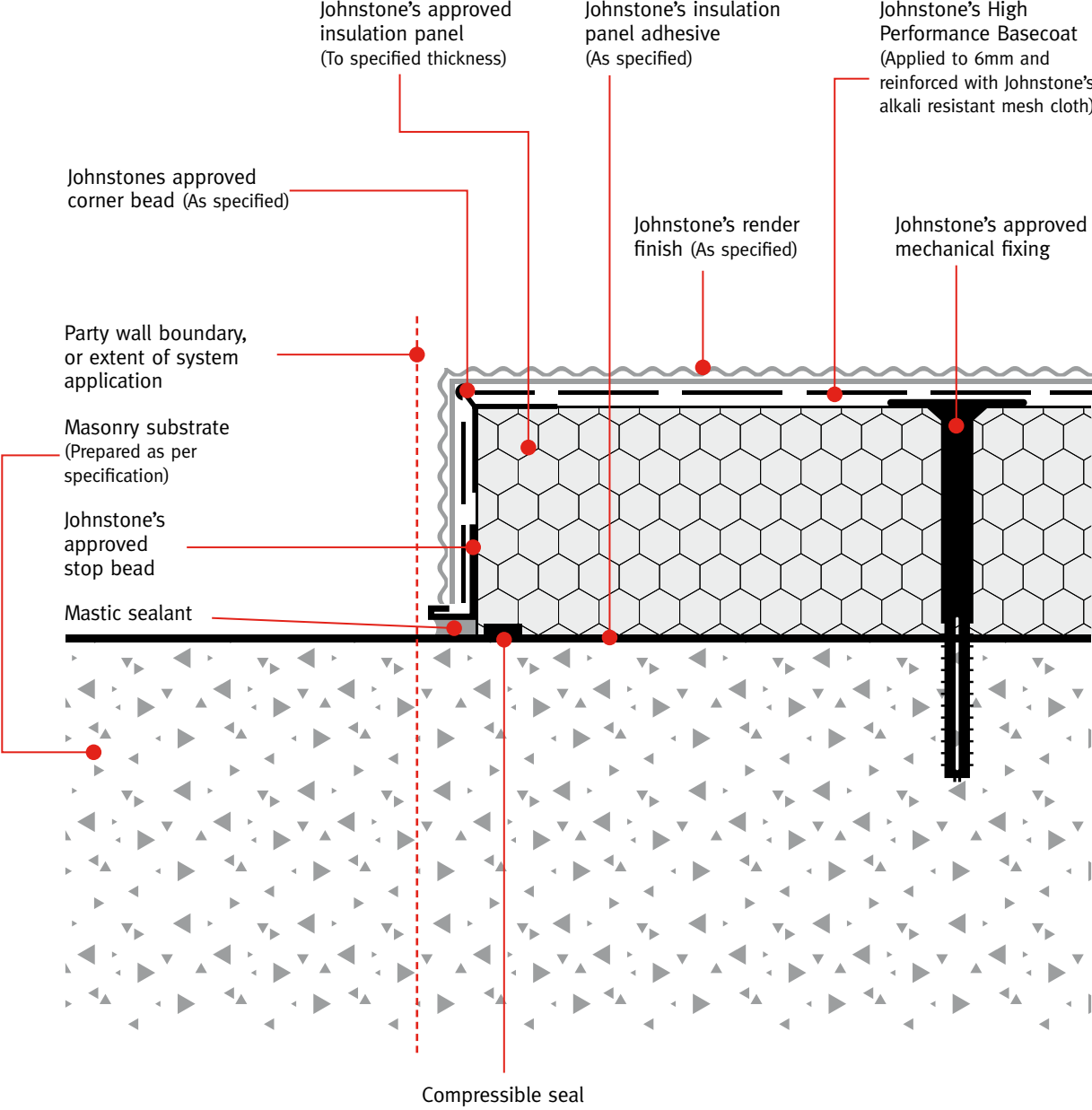

DRAWING: Standard Detail | DATE: NOV 2013 | REF: JS 11 | NO: 11

Detail Section: Vertical Stop 2 (System stop profile)

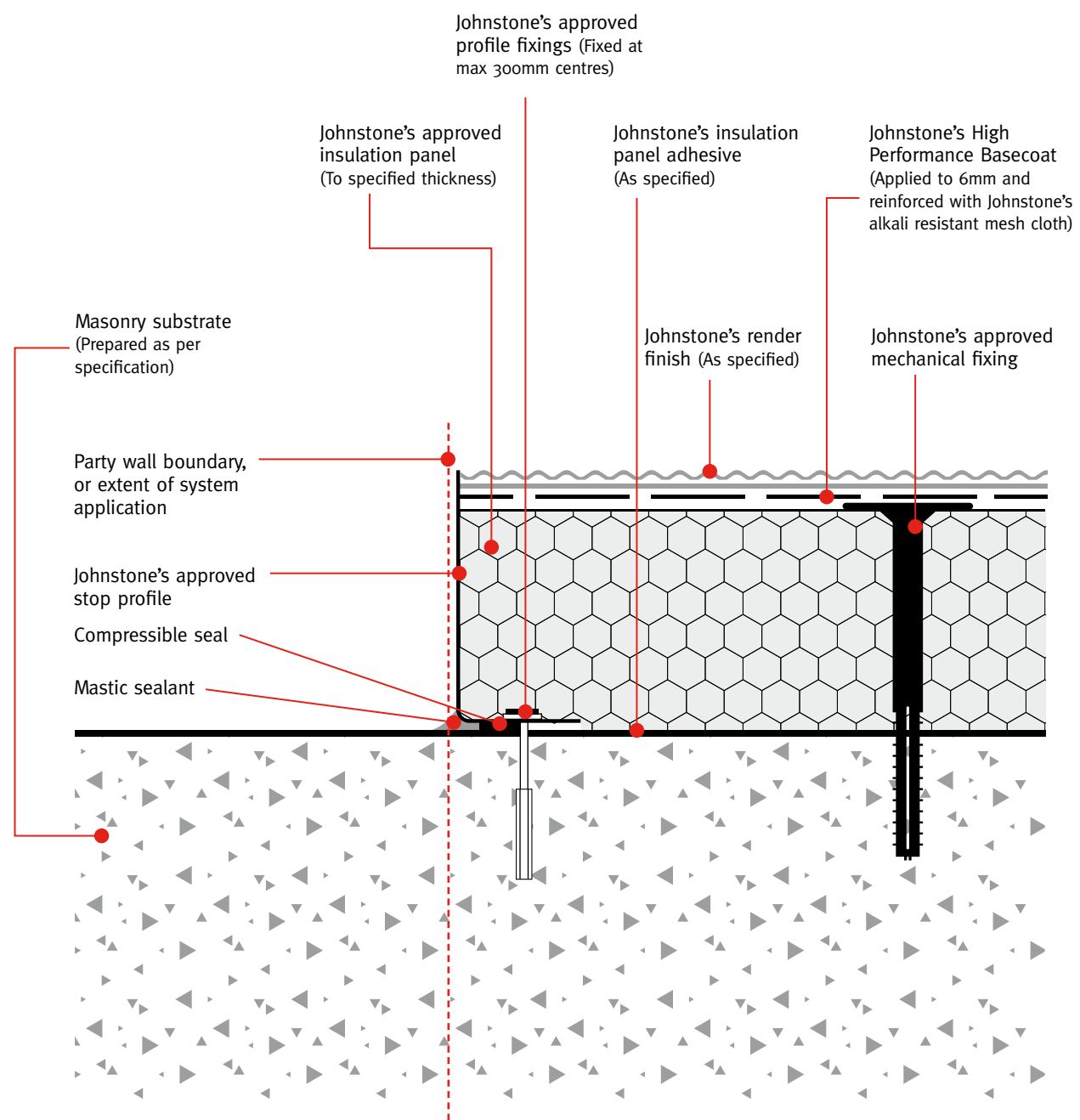

DRAWING: Standard Detail | DATE: NOV 2013 | REF: JS 12 | NO: 12

Detail Section: Movement Joint 1 (Render expansion bead)

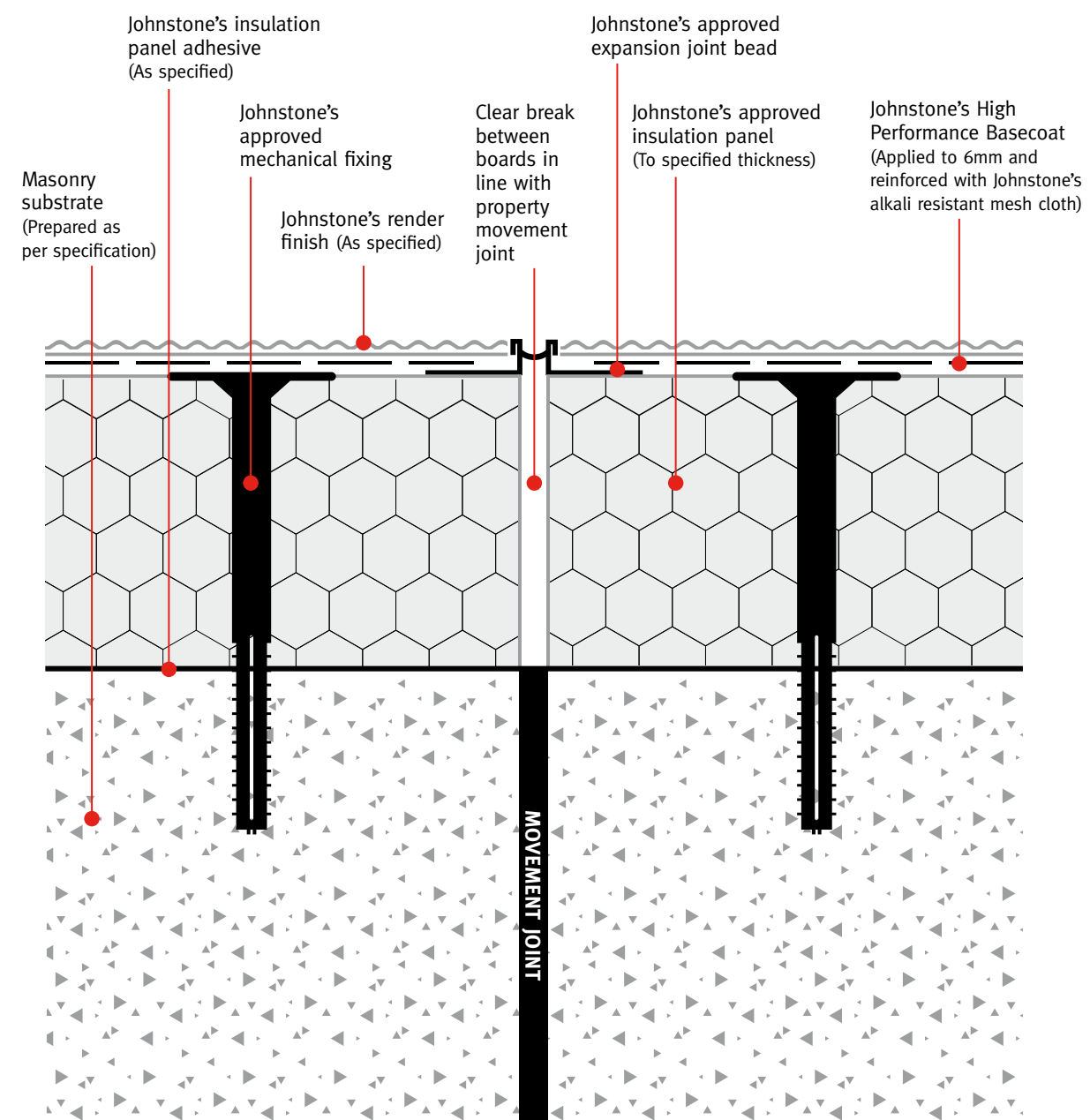

DRAWING: Standard Detail | DATE: NOV 2013 | REF: JS 13 | NO: 13

Detail Section: Movement Joint 2 (Stop profile)

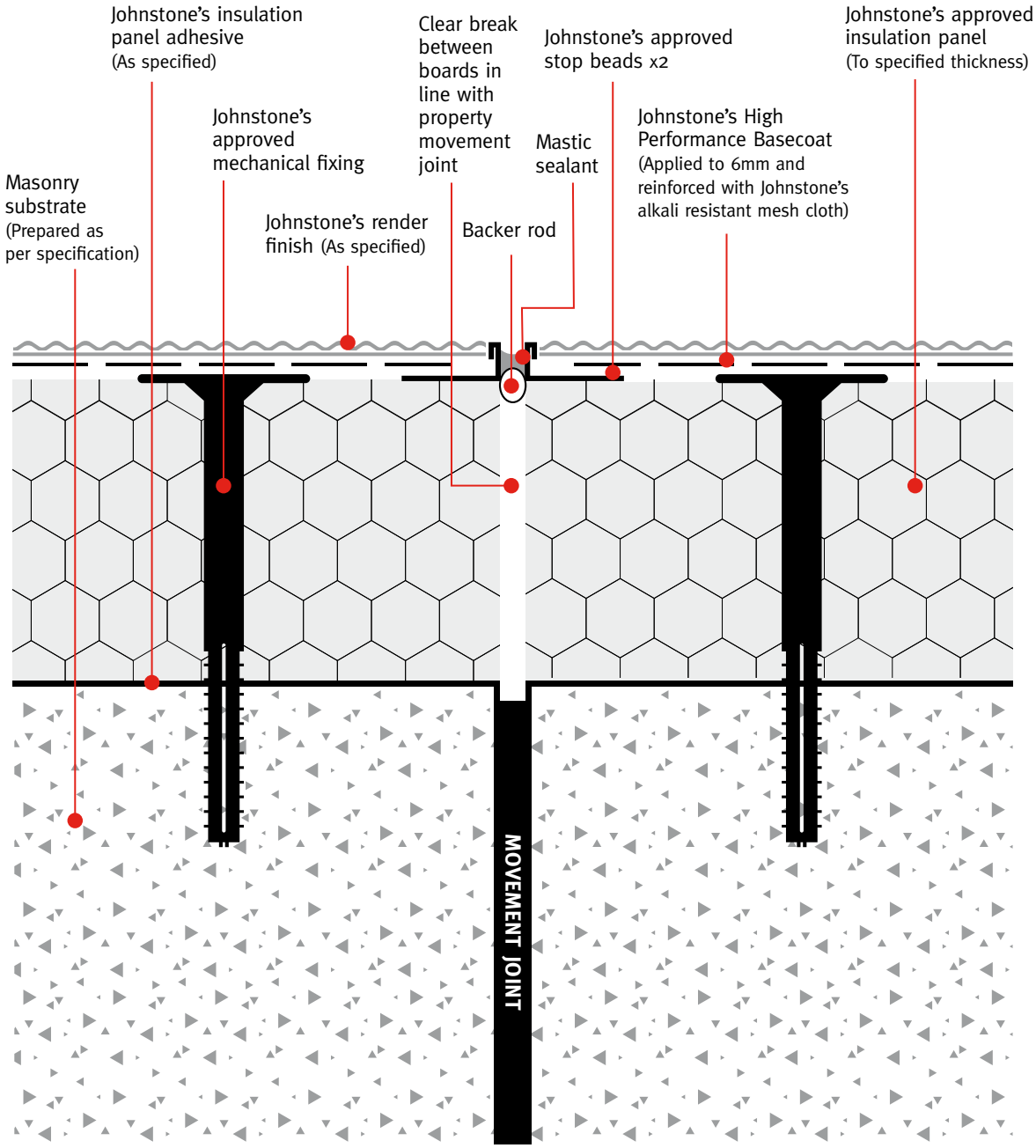

DRAWING: Standard Detail | DATE: NOV 2013 | REF: JS 14 | NO: 14

Detail Section: Roof Eaves / Soffit

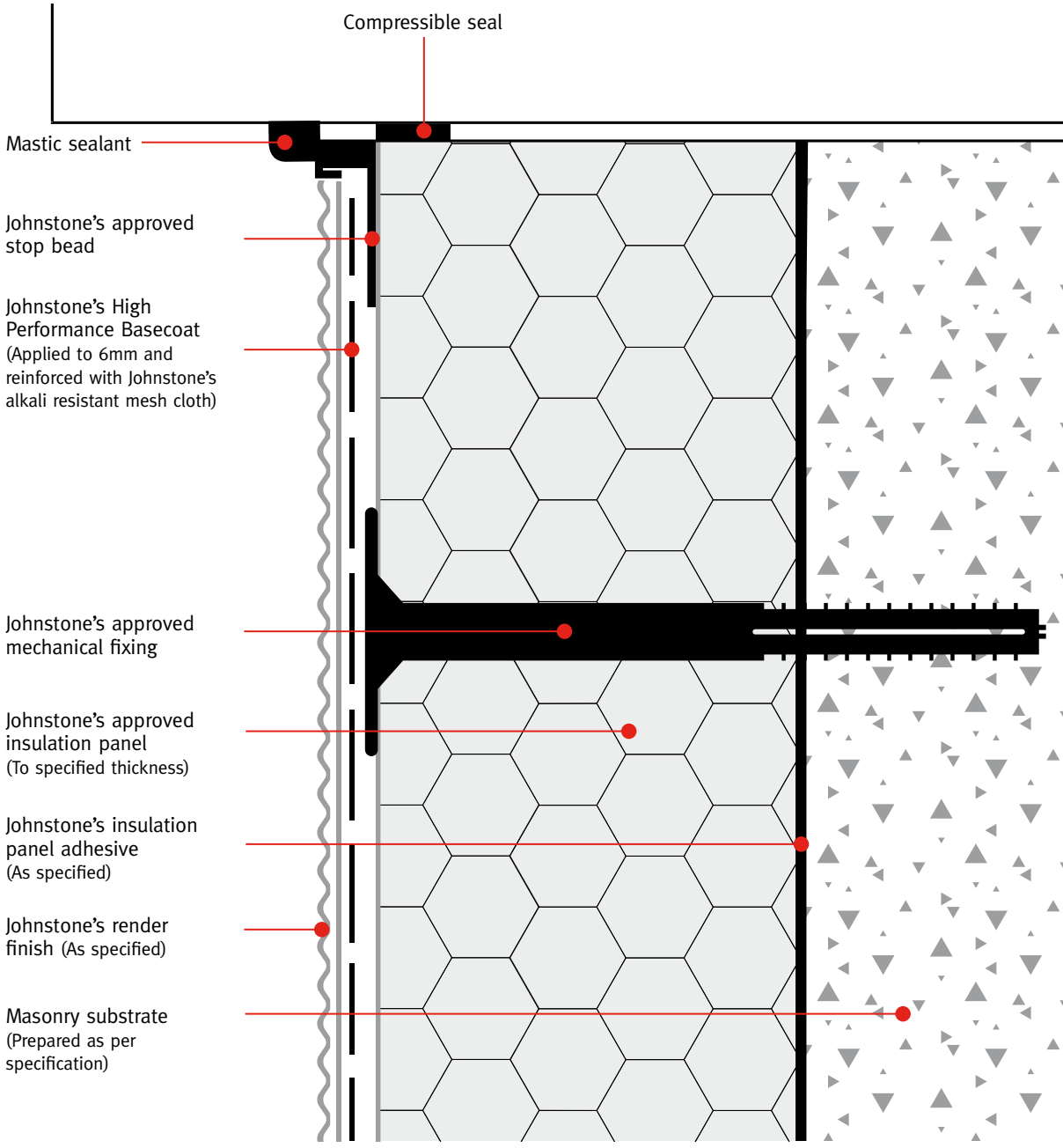

DRAWING: Standard Detail | DATE: NOV 2013 | REF: JS 15 | NO: 15

Detail Section: Verge Trim

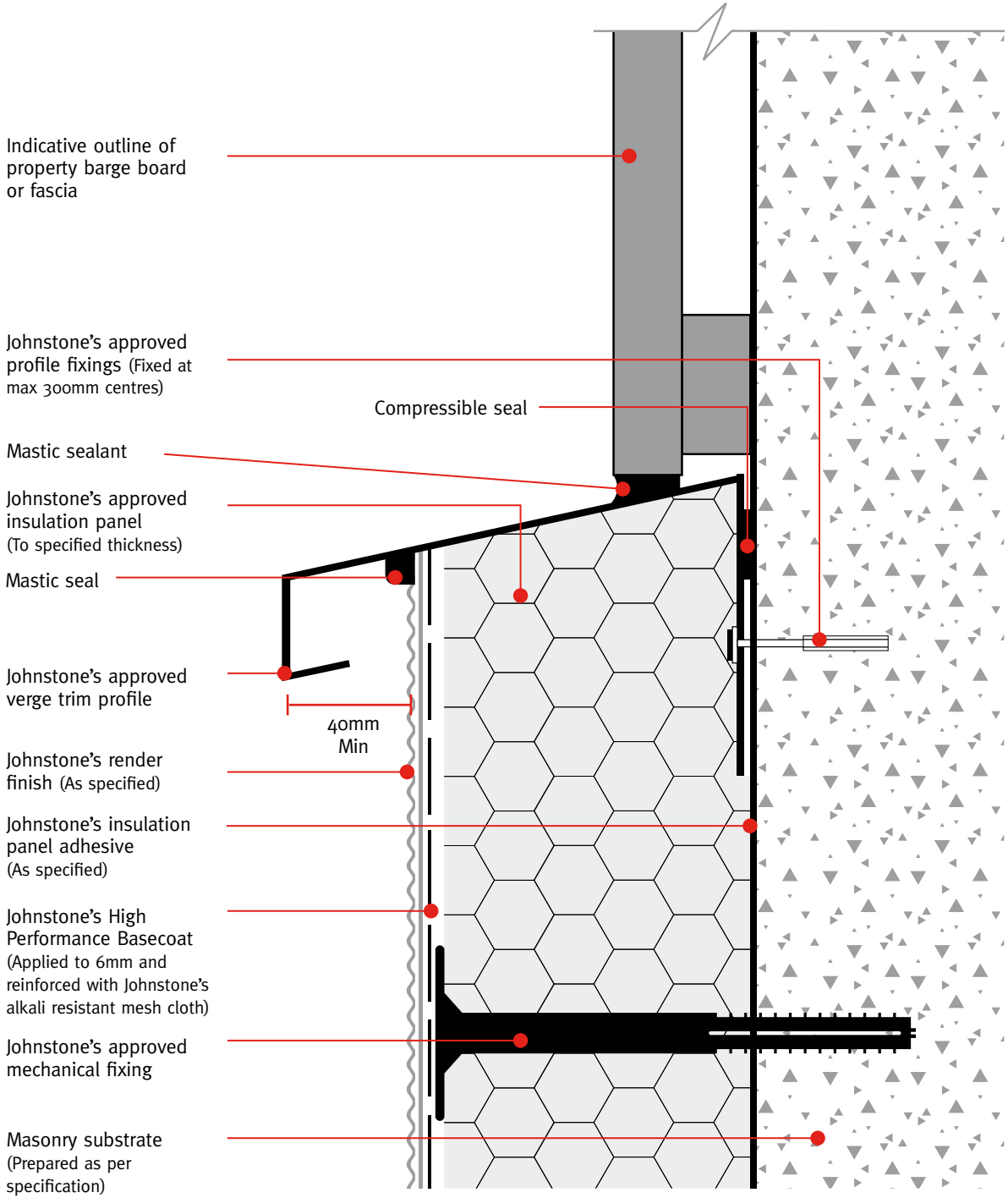

DRAWING: Standard Detail | DATE: NOV 2013 | REF: JS 16 | NO: 16

Detail Section: Roof Junction

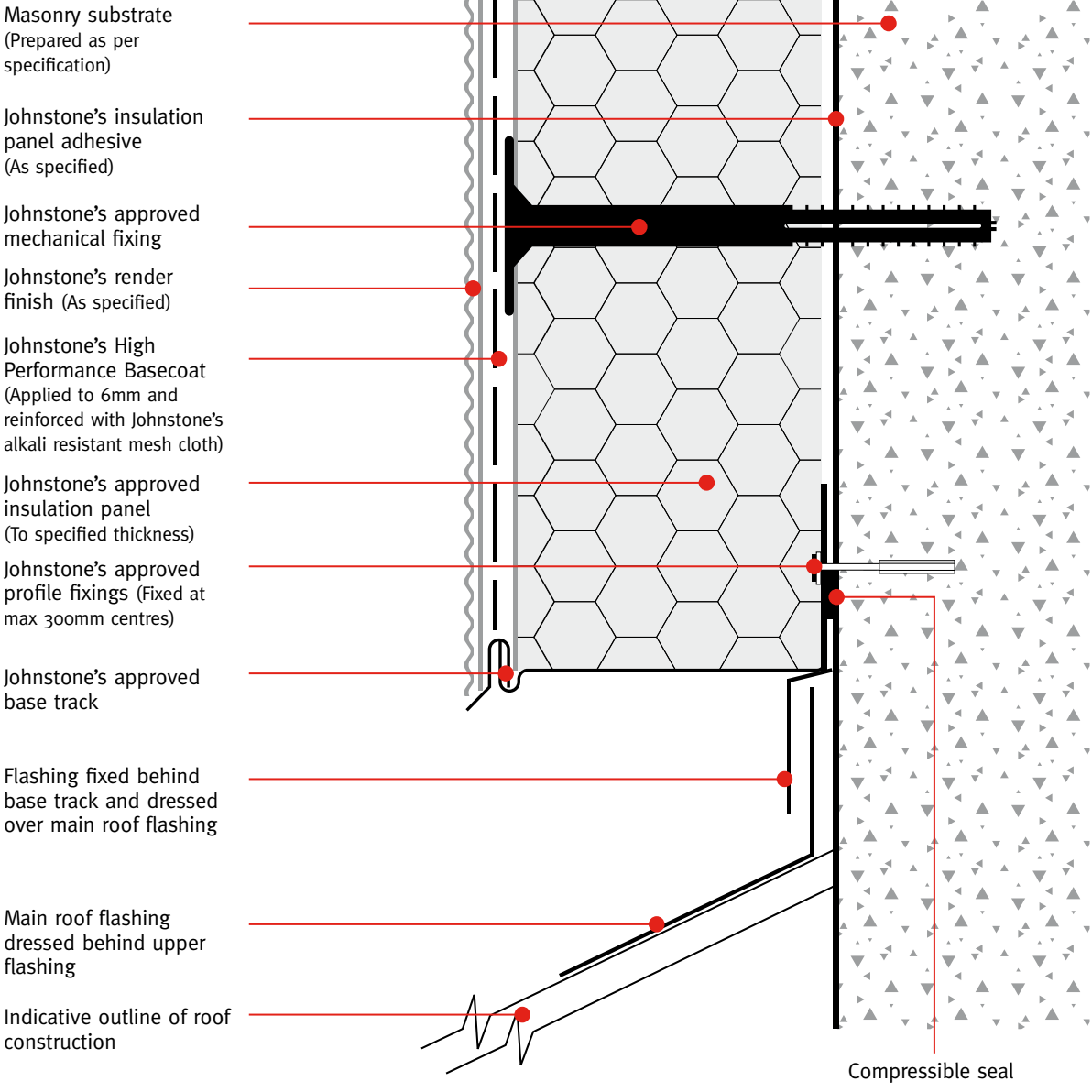

DRAWING: Standard Detail | DATE: NOV 2013 | REF: JS 17 | NO: 17

Detail Section: Coping

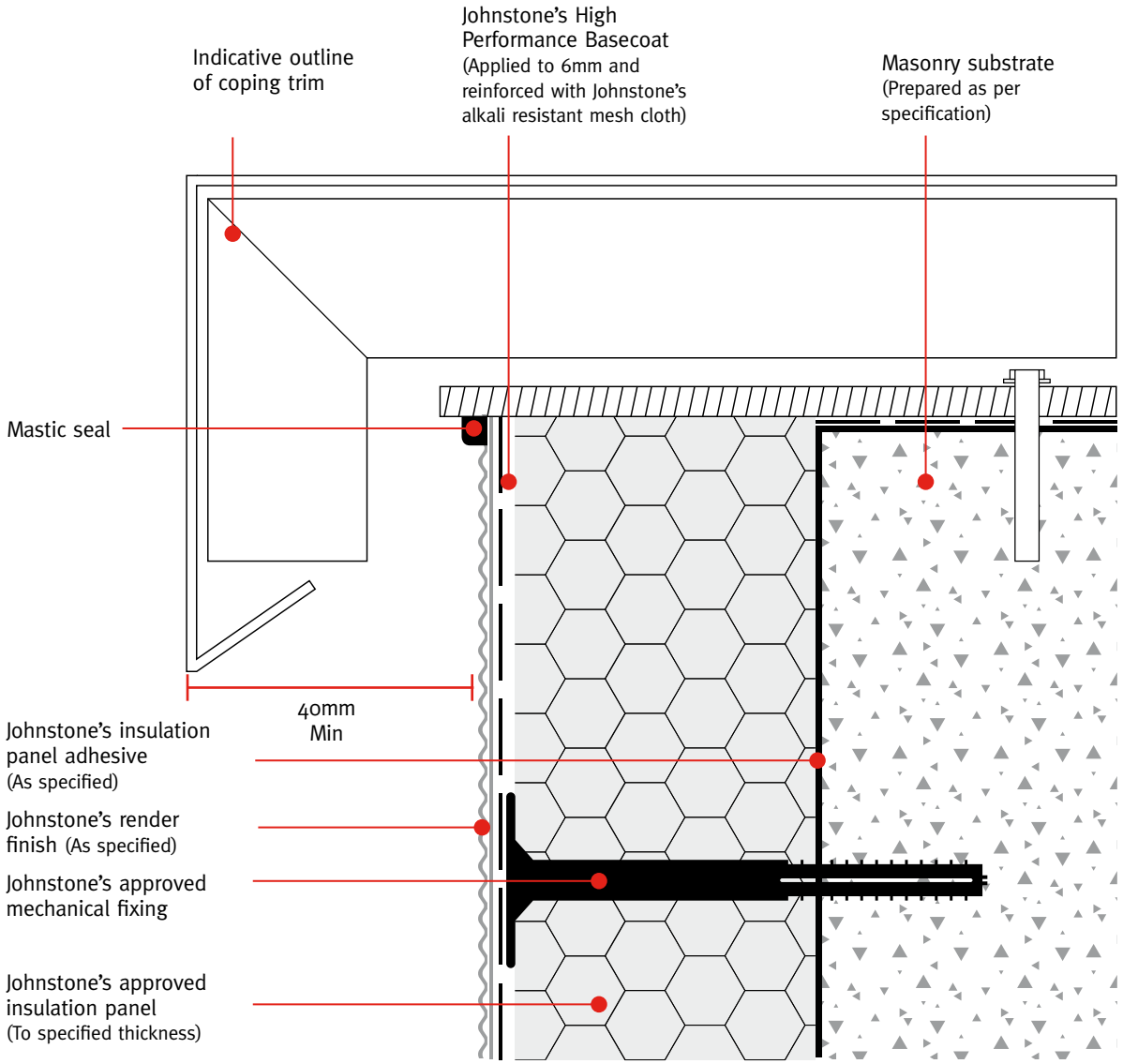

DRAWING: Standard Detail | DATE: NOV 2013 | REF: JS 18 | NO: 18

Detail Section: Fire Break

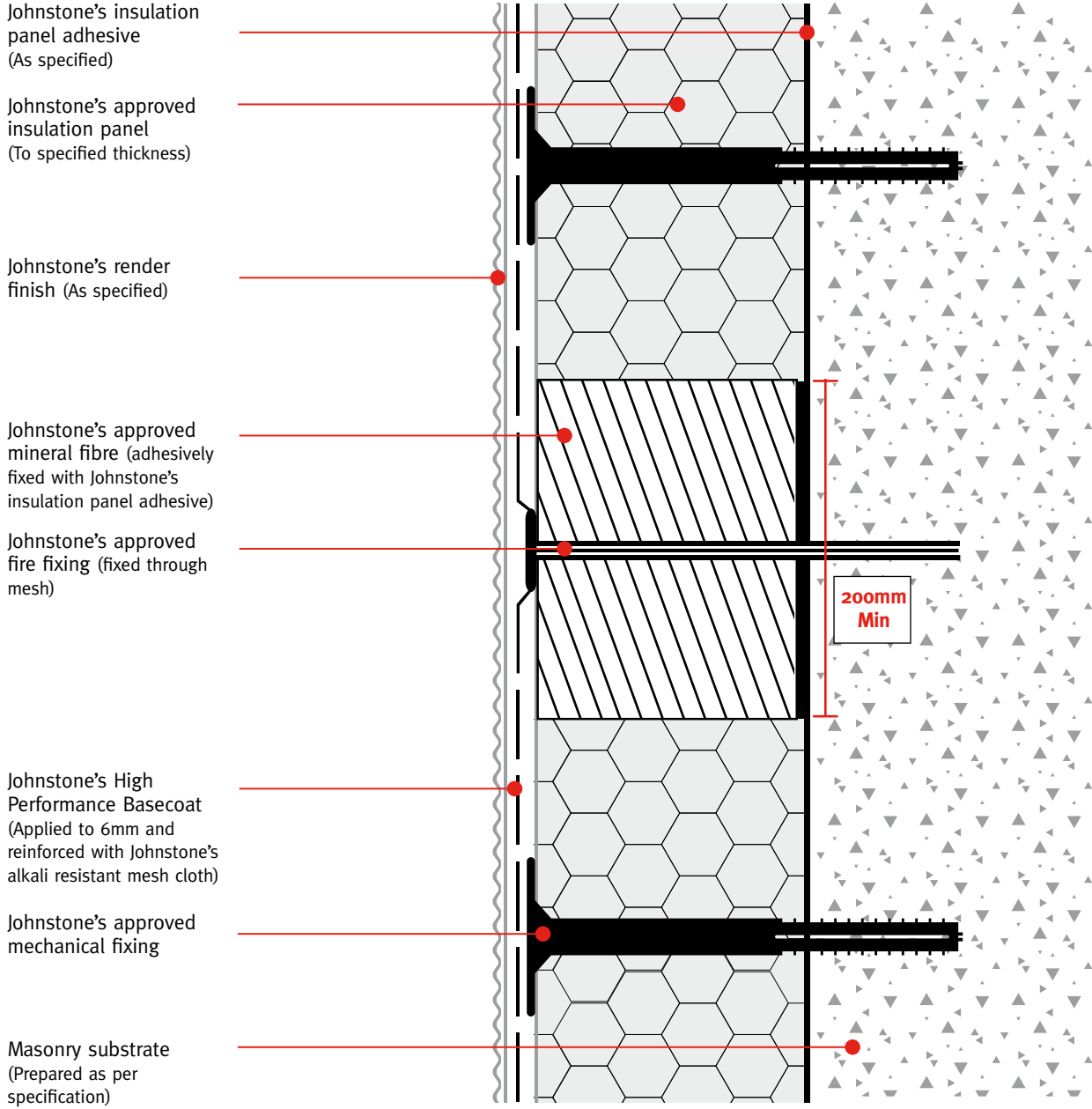

DRAWING: Standard Detail | DATE: NOV 2013 | REF: JS 19 | NO: 19

Detail Section: Timber Pattress (Light to general load bearing)

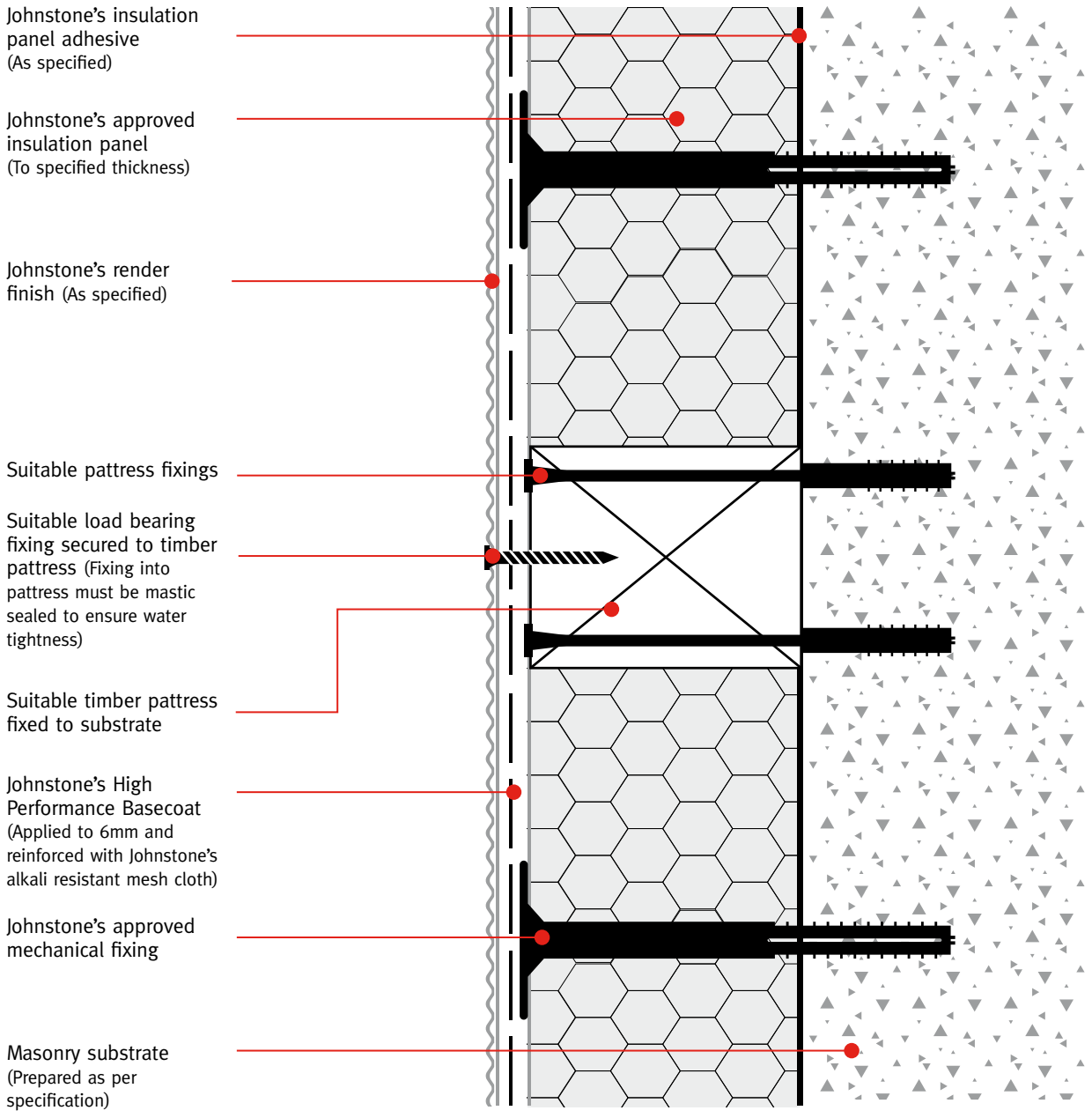

- Johnstone's insulation panel adhesive (As specified)
- Johnstone's approved insulation panel (To specified thickness)
- Johnstone's render finish (As specified)
- Suitable pattice fixings
- Suitable load bearing fixing secured to timber pattice (Fixing into pattice must be mastic sealed to ensure water tightness)
- Suitable timber pattice fixed to substrate
- Johnstone's High Performance Basecoat (Applied to 6mm and reinforced with Johnstone's alkali resistant mesh cloth)
- Johnstone's approved mechanical fixing
- Masonry substrate (Prepared as per specification)

DRAWING: Standard Detail | **DATE:** NOV 2013 | **REF:** JS 20 | **NO:** 20

Detail Section: Fixing Brackets (General to heavy load bearing)

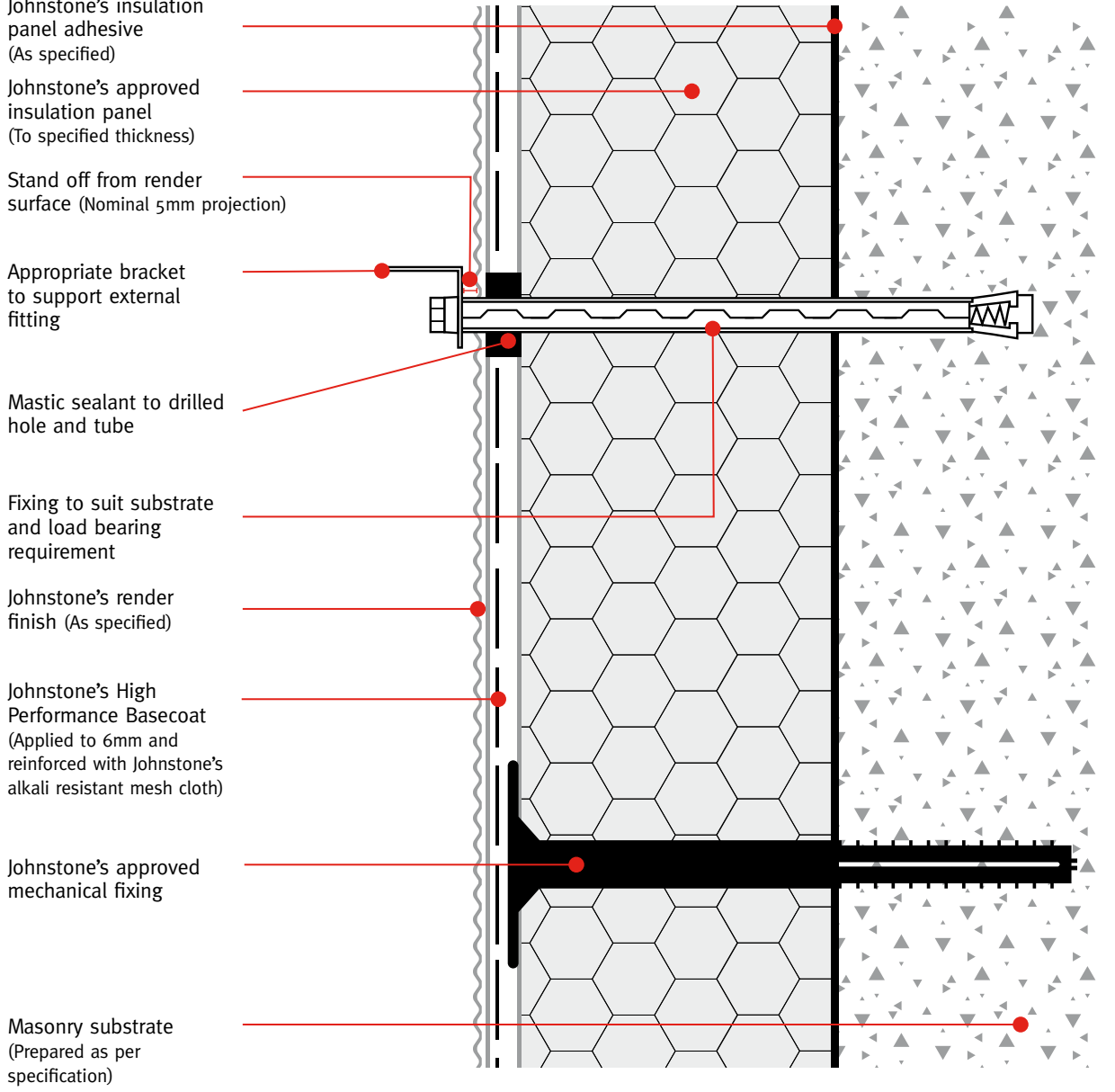

- Johnstone's insulation panel adhesive (As specified)
- Johnstone's approved insulation panel (To specified thickness)
- Stand off from render surface (Nominal 5mm projection)
- Appropriate bracket to support external fitting
- Mastic sealant to drilled hole and tube
- Fixing to suit substrate and load bearing requirement
- Johnstone's render finish (As specified)
- Johnstone's High Performance Basecoat (Applied to 6mm and reinforced with Johnstone's alkali resistant mesh cloth)
- Johnstone's approved mechanical fixing
- Masonry substrate (Prepared as per specification)

DRAWING: Standard Detail | **DATE:** NOV 2013 | **REF:** JS 21 | **NO:** 21

Detail Section: Rain Water Down Pipe Extension

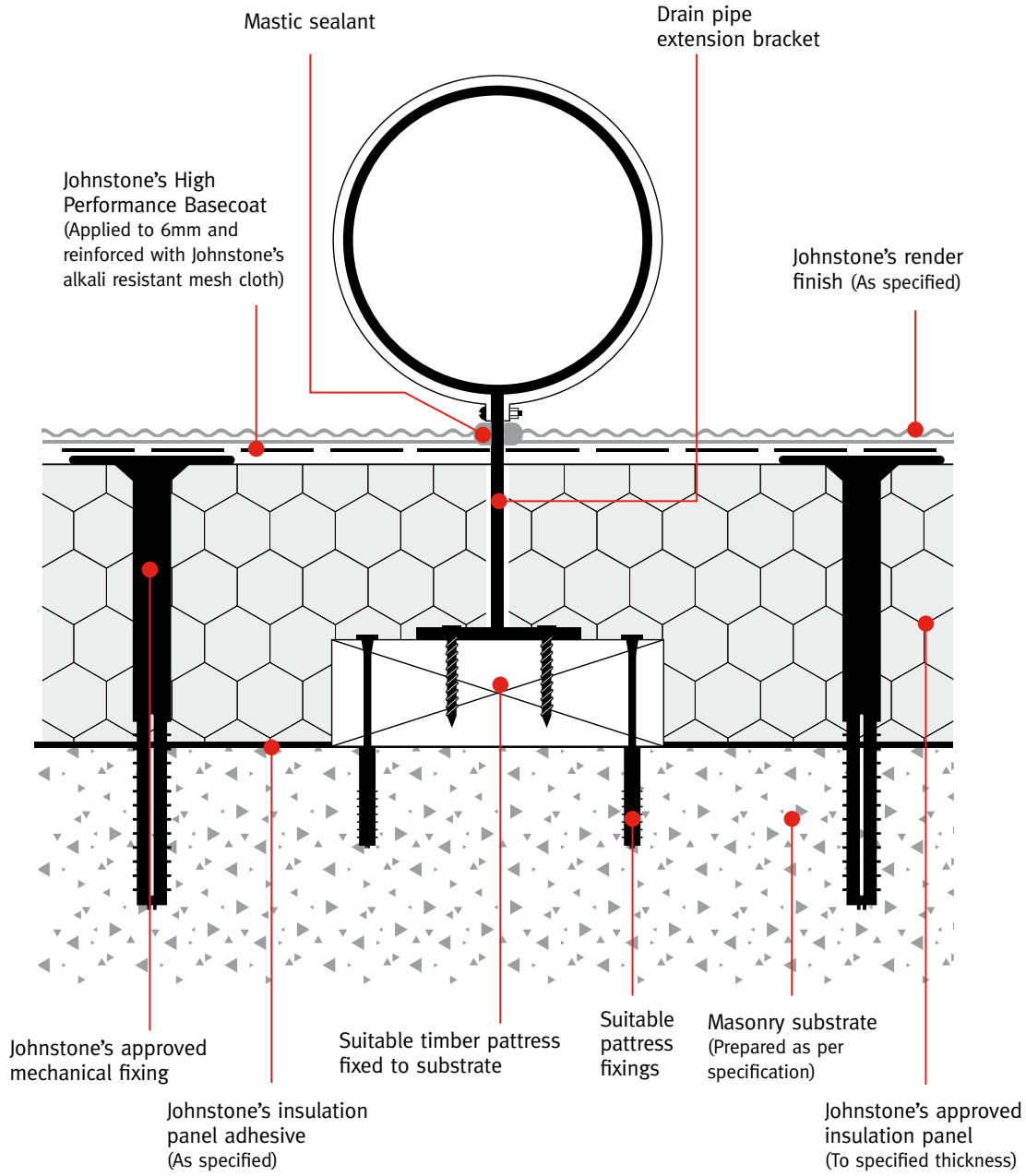

DRAWING: Standard Detail | DATE: NOV 2013 | REF: JS 22 | NO: 22

Detail Section: Service Box

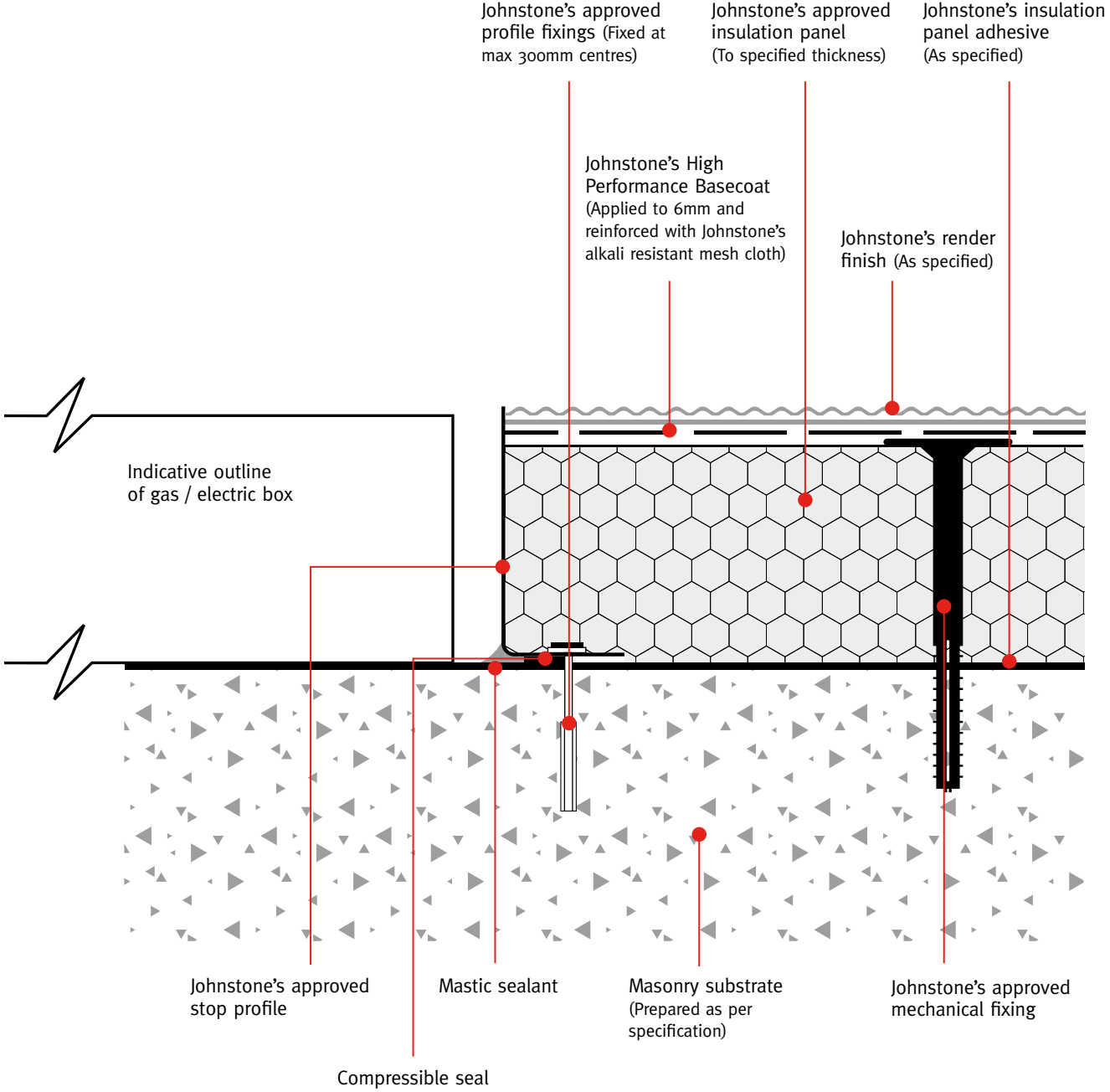

DRAWING: Standard Detail | DATE: NOV 2013 | REF: JS 23 | NO: 23

Detail Section: Gas/Utility Pipe

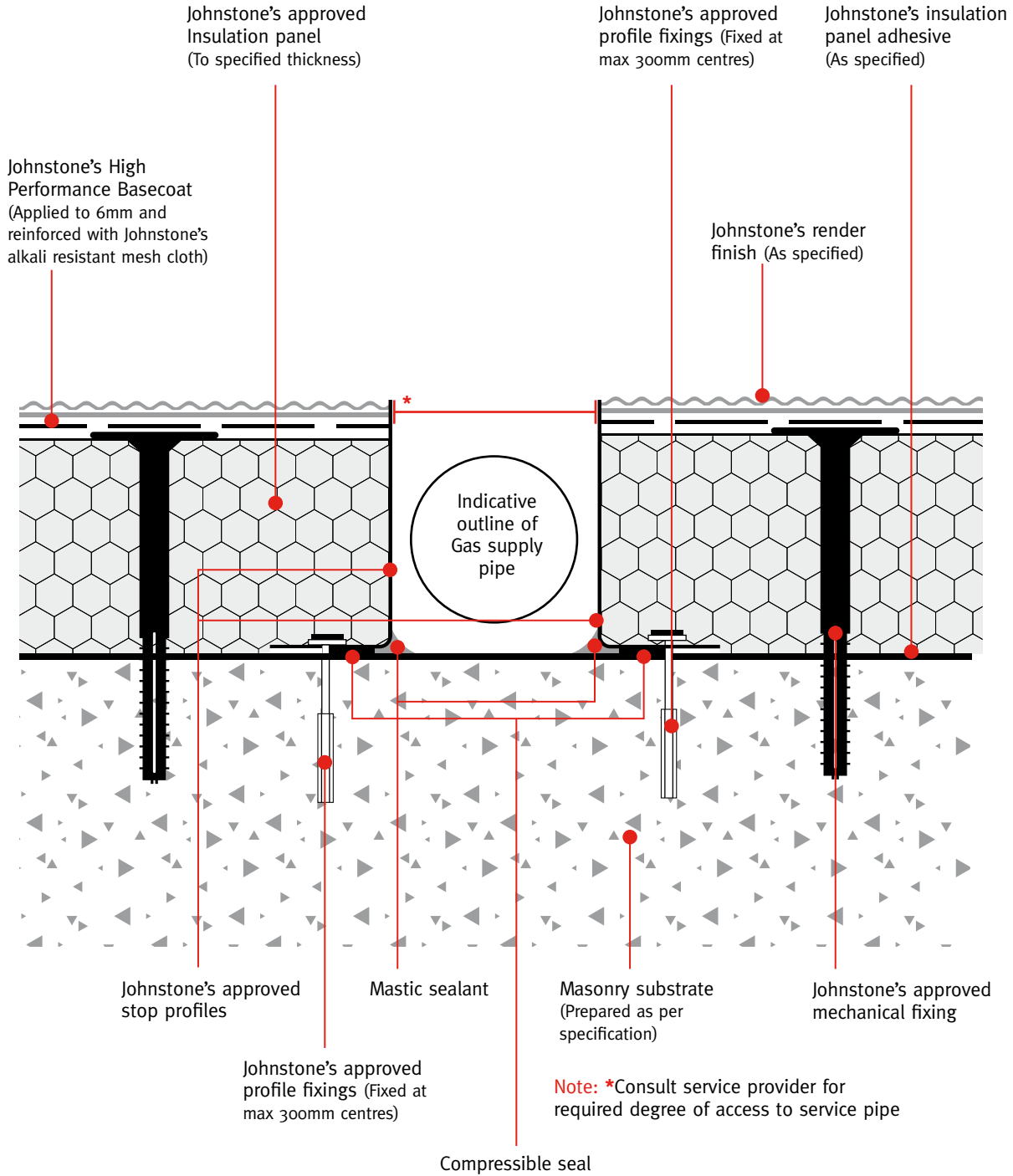

DRAWING: Standard Detail | DATE: NOV 2013 | REF: JS 24 | NO: 24

Detail Section: Pipe Or Cable

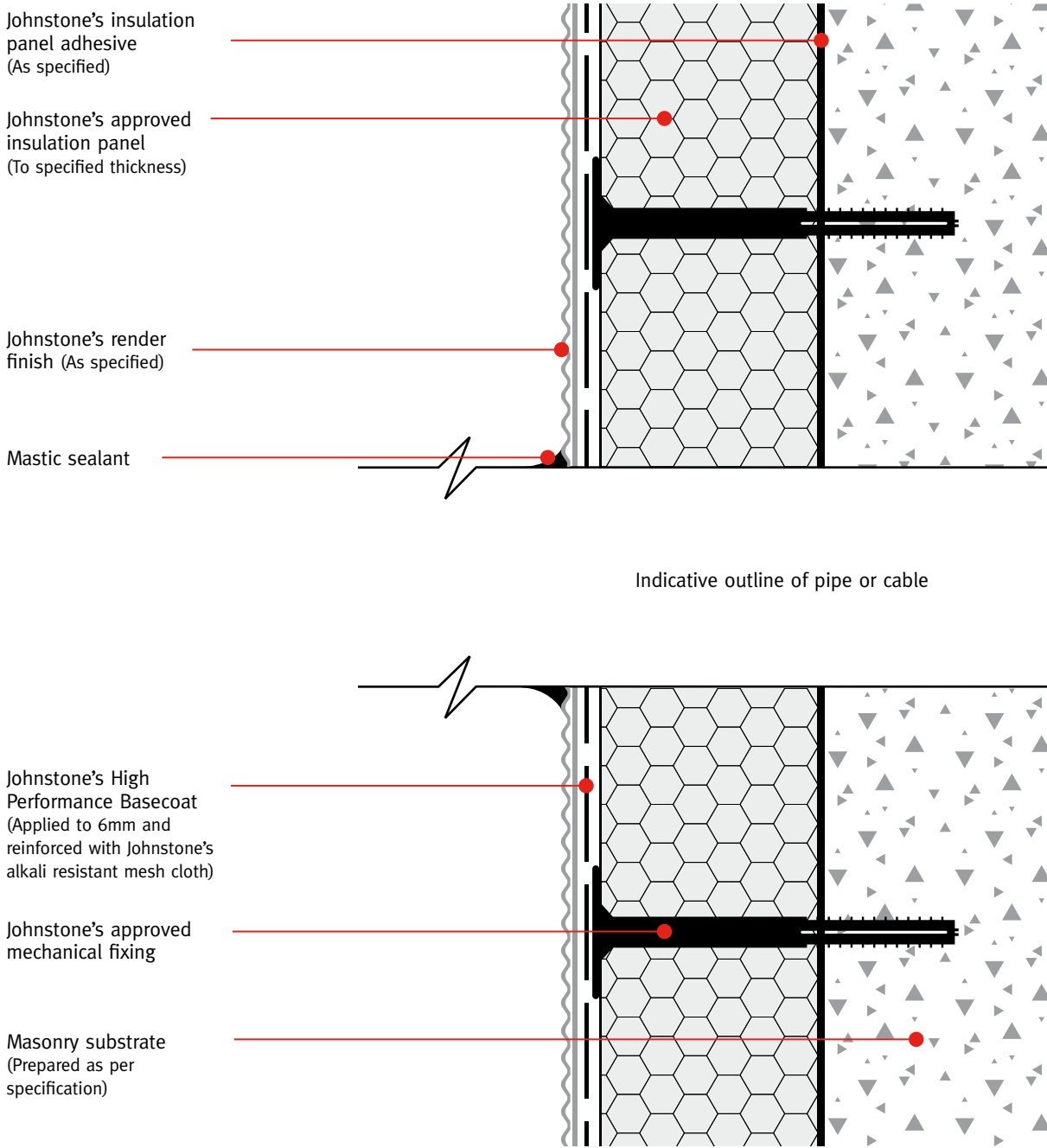

DRAWING: Standard Detail | DATE: NOV 2013 | REF: JS 25 | NO: 25

Detail Section: Heated Flue

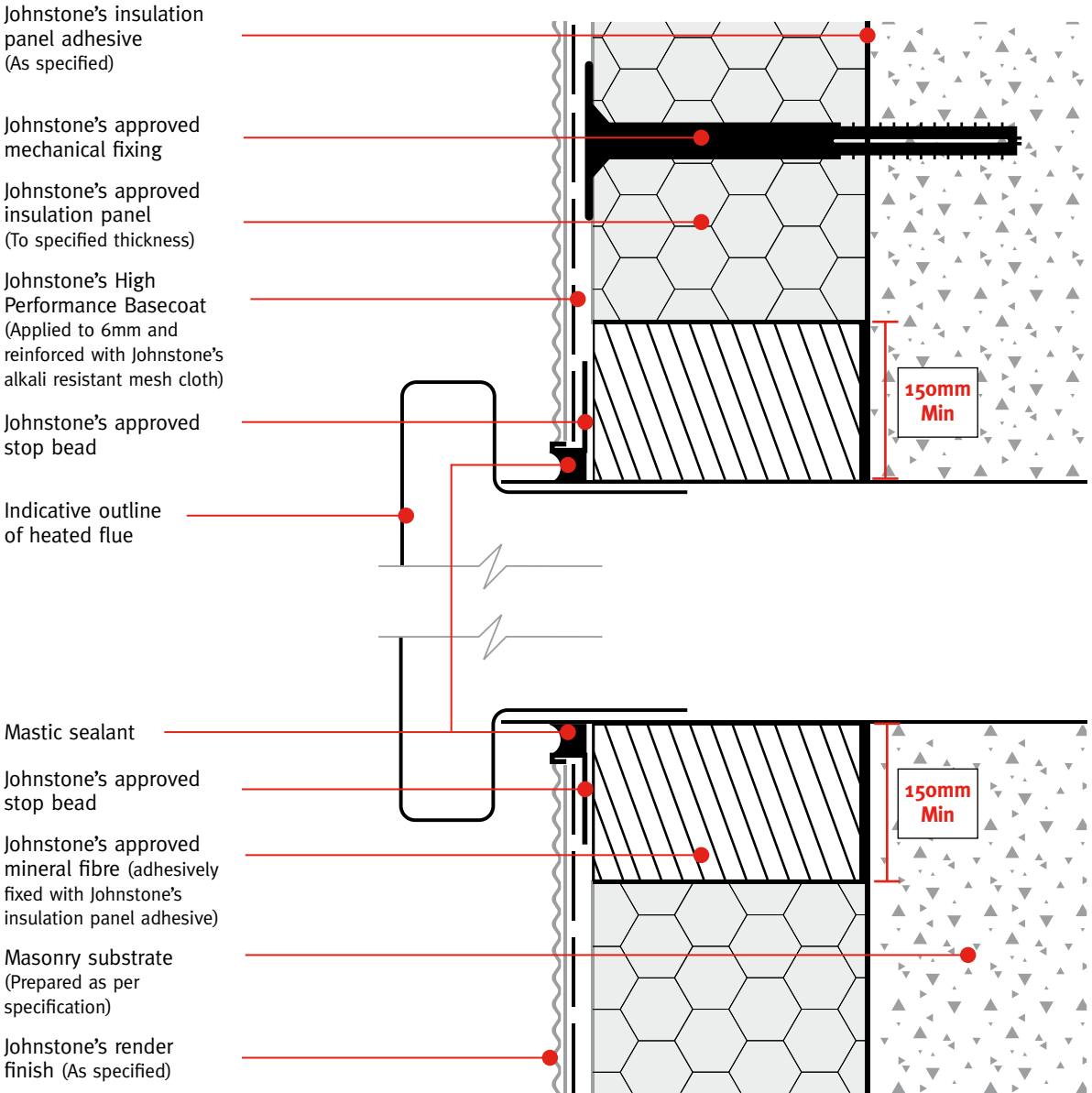

DRAWING: Standard Detail | DATE: NOV 2013 | REF: JS 26 | NO: 26

Detail Section: Service Duct

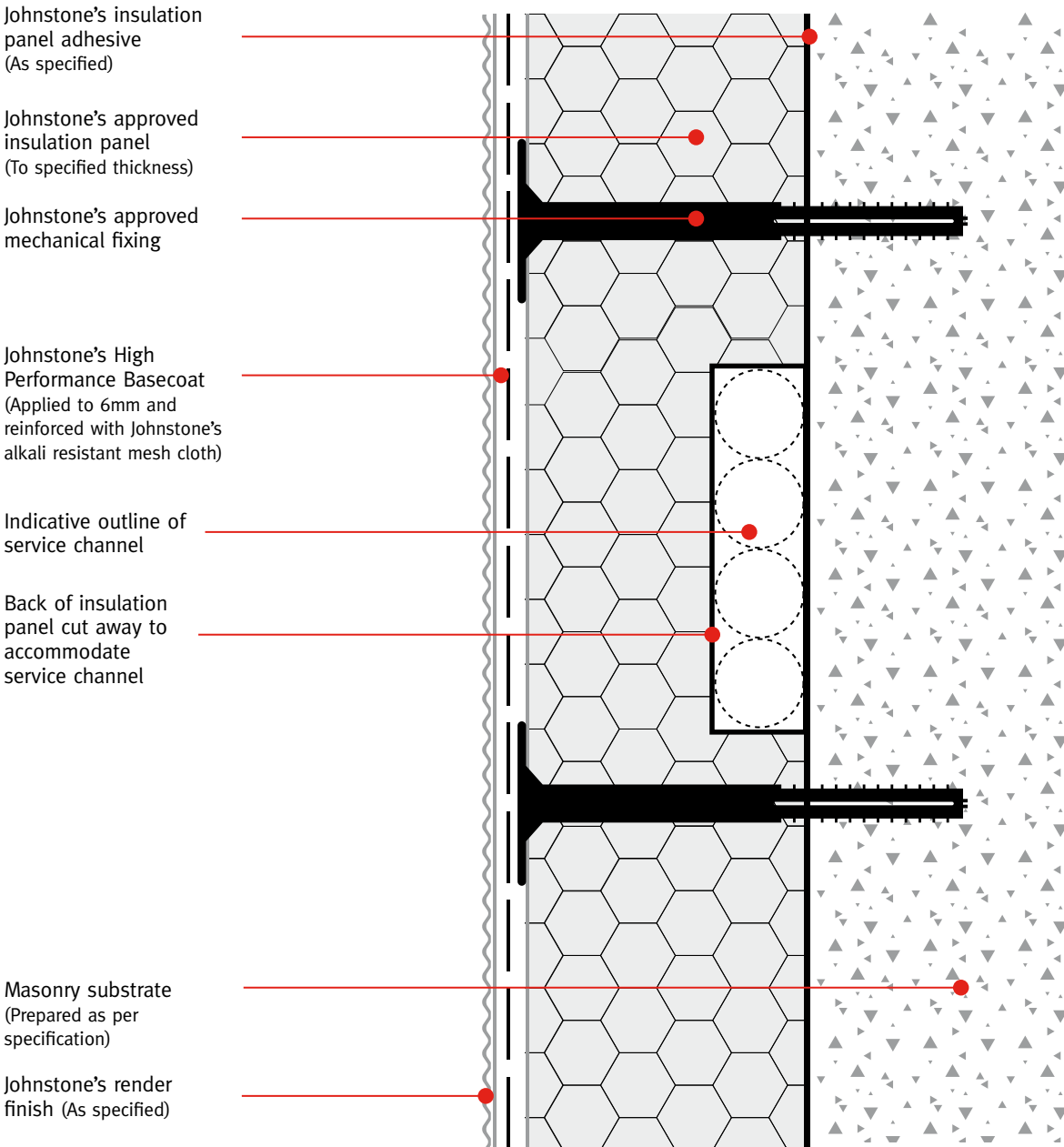

DRAWING: Standard Detail | DATE: NOV 2013 | REF: JS 27 | NO: 27

Detail Section: Base Track (Below D.P.C)

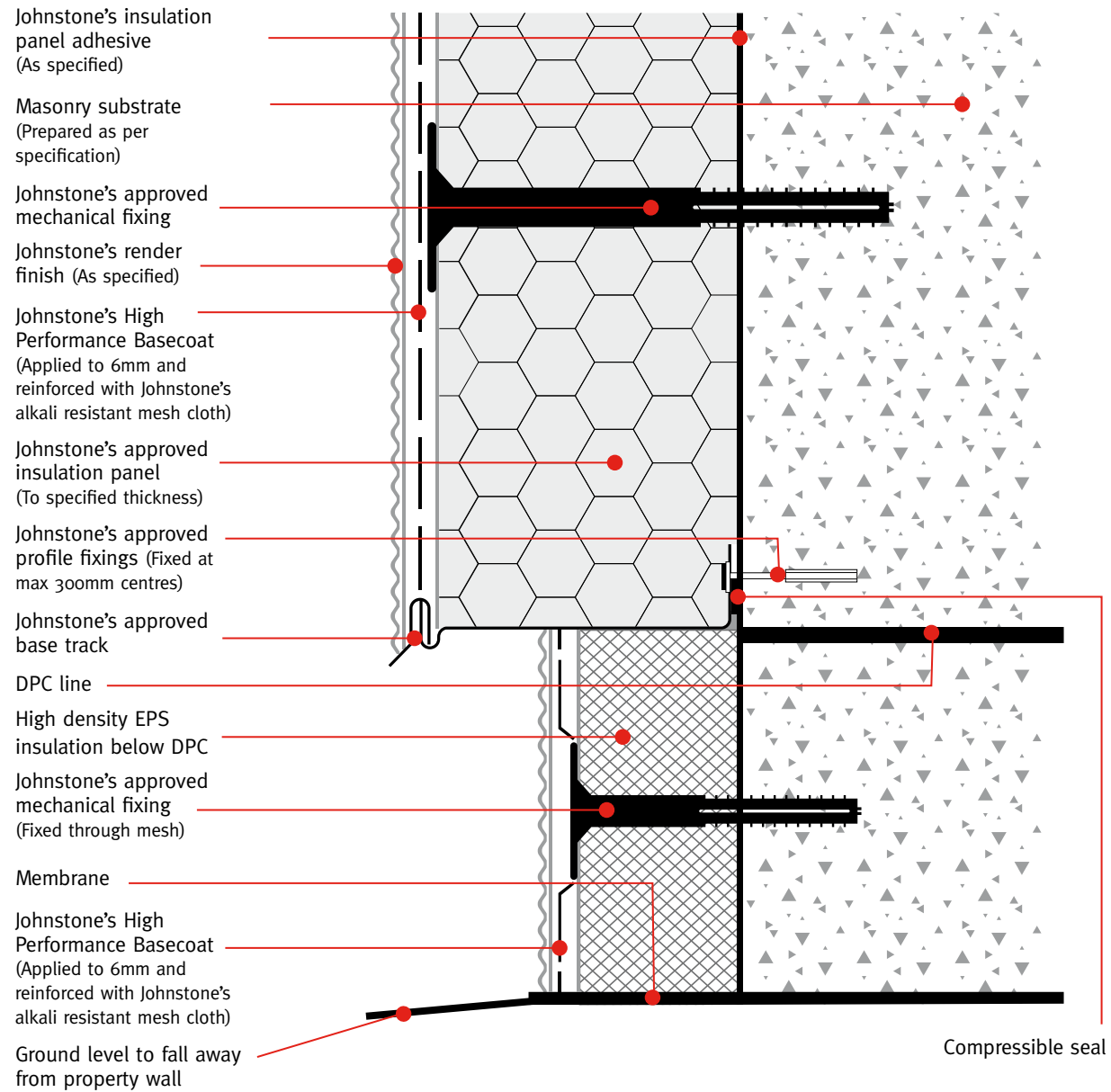

PAS 2030
Performance Indicator

Standard Improved Excellent

Note: Johnstone's do not guarantee any product or system applied below the level of property D.P.C.

DRAWING: Standard Detail | DATE: NOV 2013 | REF: JS 28 | NO: 28

Detail Section: Base Track (Below D.P.C)

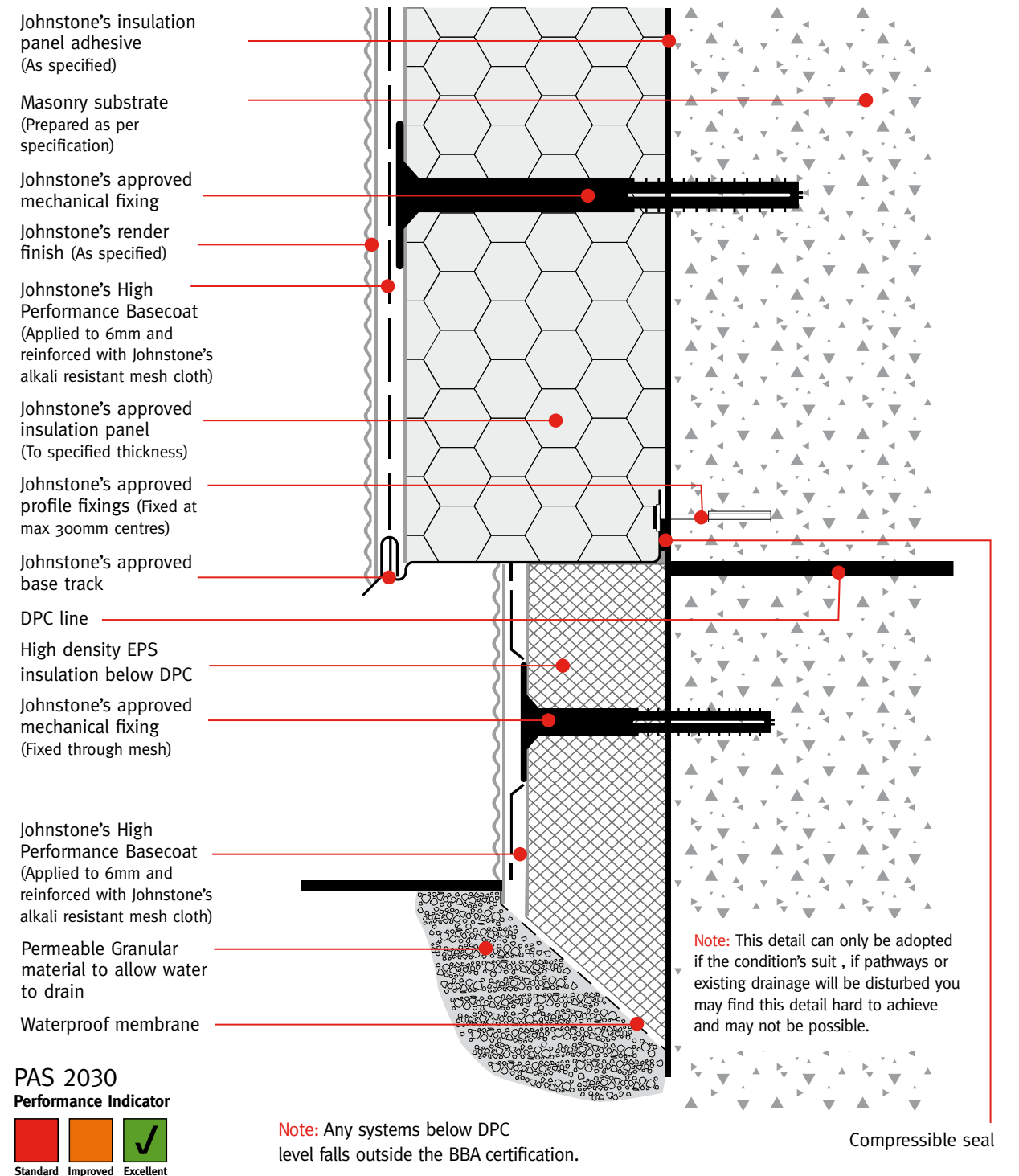

PAS 2030
Performance Indicator

Standard Improved Excellent

Note: Any systems below D.P.C. level falls outside the BBA certification.

DRAWING: Standard Detail | DATE: NOV 2013 | REF: JS 28 | NO: 29

VISIT US AT: WWW.JOHNSTONESTRADE.COM

ANY ENQUIRES PLEASE CONTACT PPG TODAY



STORMSHIELD

E W I & R E N D E R

EMAIL US AT: SPECIFIERS.ACUK@PPG.COM

CALL US ON: **01924 354354**



PPG Architectural Coatings UK Limited
Huddersfield Road, Birstall, Batley,
West Yorkshire WF17 9XA. United Kingdom

15427