

# ACO Water Management: Civils + Infrastructure

Uniclass L2123 + L7315	EPIC J3413
CI/SfB (52.5)	

ACO MultiDrain® MD

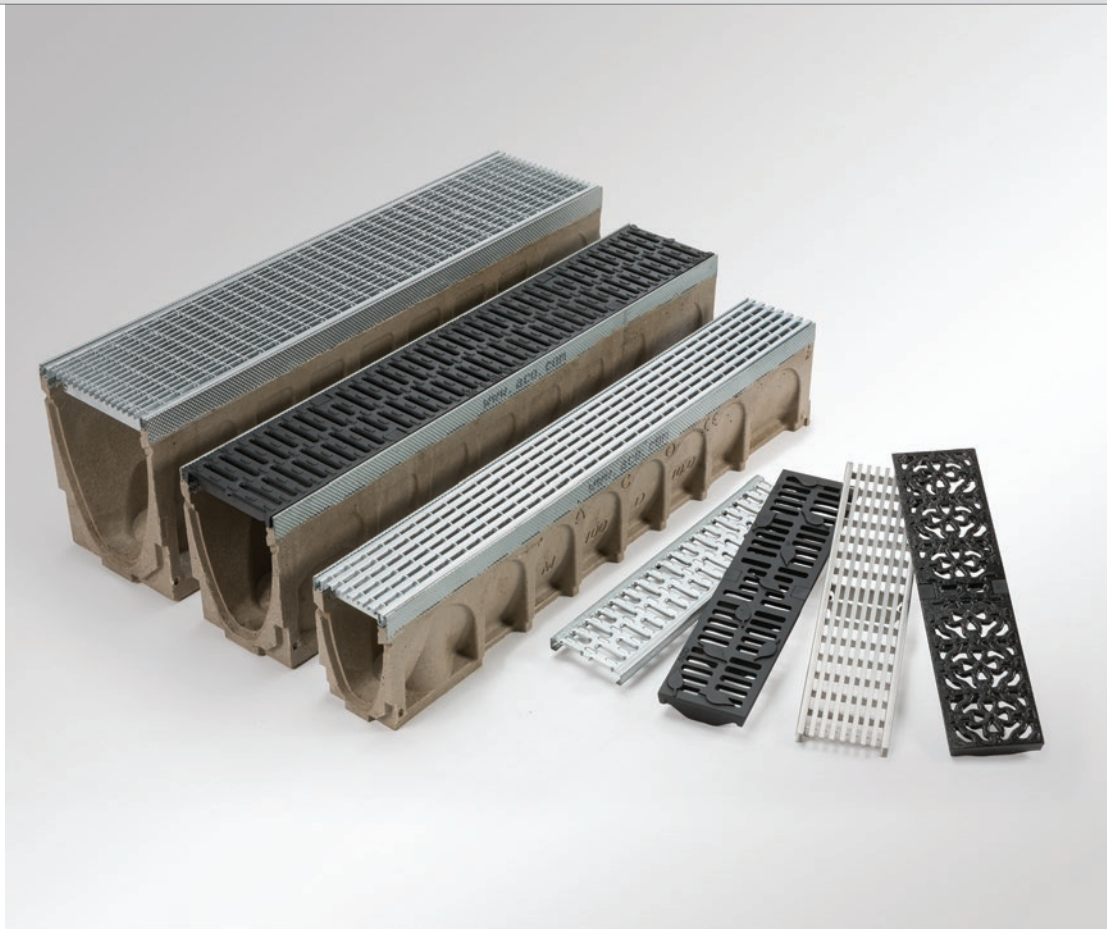

*ACO MultiDrain® MD*

**Medium duty channel drainage system**



# Introduction to the ACO Group

Throughout the world ACO branded drainage and surface water management systems are recognised for their innovative design, high quality manufacture, environmental excellence and industry leading performance.

Today the ACO Group has a research and production base that reaches across four continents. This unmatched resource pioneers the development of solutions that are tailored to individual applications, meeting the need for high performance, sustainable products that deliver optimum value throughout their operational life.

## ACO Technologies plc

ACO operates as ACO Technologies plc in the United Kingdom. Founded over 30 years ago, the company has grown quickly on a reputation for design innovation and customer service.

There are now 2 divisions within ACO Technologies that serve every sector of the construction industry, providing solutions for applications as diverse as rail, highways, airports, landscaping, retail, distribution centres and environmentally sensitive projects.



To help architects, designers and contractors meet the legal requirements that now tightly control the way surface water is managed, ACO has created its unique system chain that combines a 'Surface Water Management Cycle' – Collect, Clean, Hold, Release, with the service support of Train, Design, Support and Care.

These processes enable ACO to offer a combination of product and service expertise necessary for the complete and sustainable management of surface water drainage.



# Contents

Introduction to ACO MultiDrain® MD	4
Channel range layout	6
Features overview	8
Grating styles	10
<hr/>	
<b>Channels with UltraSTEEL™ galvanised edge rails</b>	
ACO M100D channels with UltraSTEEL™ galvanised edge rails	13
ACO M150D channels with UltraSTEEL™ galvanised edge rails	14
ACO M200D channels with UltraSTEEL™ galvanised edge rails	14
Multifunctional endcaps	15
Step connectors	15
ACO Universal Gully	15
ACO Sump units with UltraSTEEL™ galvanised edge rails	16
ACO drain unions and foul air traps	17
ACO Discrete slot drainage	18
ACO M100D gratings compatible with UltraSTEEL™ galvanised edge rails	21
ACO M150D gratings compatible with UltraSTEEL™ galvanised edge rails	24
ACO M200D grating compatible with UltraSTEEL™ galvanised edge rails	26
<hr/>	
<b>Channels with stainless steel edge rails</b>	
ACO M100DS channels with stainless steel edge rails	28
ACO M150DS channels with stainless steel edge rails	29
ACO M200DS channels with stainless steel edge rails	29
Multifunctional endcaps	30
Step connectors	30
ACO Sump units with stainless steel edge rails	31
ACO M100DS gratings compatible with stainless steel edge rails	32
ACO M150DS gratings compatible with stainless steel edge rails	34
ACO M200DS grating compatible with stainless steel edge rails	36
<hr/>	
<b>ACO MultiDrain®: Problem Solving Drainage Solutions</b>	
Channel footpath drainage	38
Downpipe connectors	40
ACO MultiDrain® MD Accessories – features, functions and benefits	41
Design Software	46
Design Support Services	47
Installation detail	48
Chemical Resistance Chart	50
Specification Clause / Recycled Content / CE Conformity	51



# Introduction to ACO MultiDrain® MD

ACO MultiDrain® MD benchmarks a new approach in the planning, delivery and installation of general purpose channel drainage systems. Designed to provide an effective solution for a wide variety of applications, ACO MultiDrain® MD system maximises functionality whilst using the minimum number of components.

## What is ACO MultiDrain® MD?

ACO MultiDrain® MD channel drainage system is manufactured from Vienite®, ACO's sustainable high strength material. It is available in three widths; 100mm, 150mm and 200mm, and has a variety of depths and slopes.

The channel units are certified to BS EN 1433: 2002 Load Class D 400\* and form the main components of the system.

Depending on the load class and application requirement, a wide range of gratings are available to complete the system. You can now choose from a range of traditional and discreet slot drainage gratings, solid covers and cross footpath drainage units to ensure all applications are catered for.

All gratings within the system are fitted with ACO Drainlock™, a bar-less locking device which reduces the risk of blockage and improves hydraulic capacity. The mechanism also provides for easy installation and maintenance of the system.

As standard, channels are manufactured with UltraSTEEL™ protective edge rails. The UltraSTEEL™ rails, with their unique patented design, provide optimum channel protection and improved bonding between channel sides and the surrounding pavement material.



ACO MultiDrain® MD System can provide a channel drainage solution for many applications by simply selecting the appropriate channel depth and grating type. Some of the applications that can be catered for are listed below.

- ▶ Threshold drainage
- ▶ Public landscaping
- ▶ Car parking
- ▶ Light industrial
- ▶ HGV parking
- ▶ Petrol station forecourts
- ▶ SuDS

## Discreet slot drainage

Apply the ACO Brickslot grating to the channel unit to form an unobtrusive drainage system. The off-set grating can be used as a solution for threshold drainage and also against buildings eliminating difficult installations. The gratings are suitable for BS EN 1433: 2002 Load Class C 250 and D 400\* applications.

ACO Brickslot gratings are available for 100mm, 150mm and 200mm wide channels, in both galvanised or stainless steel. See page 18 for further details.

## Services ducts

The ACO MultiDrain® MD System includes a solid cover grating which when applied to the main channel unit provides a secure shallow trench with easy access to services and cabling.

## Cross footpath drainage

Where roof drainage from down pipes is required to cross the footpath into the road gutter, a range of down pipes connectors, kerb outlets and shallow channels are available within the ACO MultiDrain® MD System range. See page 38 for further details.

**This system is only available in the ACO MultiDrain® M100D System.**

## Threshold drainage

The ACO MultiDrain® MD System can be used to provide unobtrusive drainage around building entrances, compliant with the building regulations (England and Wales Part M, Scotland Section 4, Northern Ireland Part R). Simply select the appropriate grating to meet your aesthetic requirements.

# Why choose ACO MultiDrain® MD?

## Made from sustainable materials

ACO MultiDrain® MD channel elements are manufactured from Vienite®. Vienite® is ACO's new high strength sustainable material that meets environmental and sustainability targets for construction products.

Vienite® utilises high levels of post consumer recycled waste, but unlike some recycled materials does not compromise on strength or long term performance.

Vienite's high strength characteristics means the material is four times stronger than traditional concrete and has a low water absorption rate. It is also resistant to freeze thaw attack and has excellent chemical resistance.

At the end of the products operational life, Vienite® can be collected, processed and returned to production as a raw material.



## System benefits

- ▶ Provides an efficient drainage solution for a wide variety of applications
- ▶ Range of constant, sloped and shallow depth channels
- ▶ Caters for a range of catchment areas
- ▶ Strong and robust channel design
- ▶ Patented UltraSTEEL™ channel edge rail for improved strength and durability
- ▶ CE Marked and BS EN 1433: 2002 certificated to Load Class D 400\*
- ▶ Extensive choice of gratings and accessories for many applications
- ▶ Choice of outlet options, gullies, sumps or channel knockouts
- ▶ Unique ACO Drainlock™ grating fixing improves hydraulic capacity
- ▶ Lightweight design is simple and fast to install
- ▶ 100% recyclable
- ▶ Ideal for use against building facades or as a Part M threshold drainage solution when used with ACO MultiDrain® Brickslot grating



## NEW ACO Hydraulic Design Software

Register online for our free, secure online design software:

- ▶ All designs are securely stored and easily accessed online
- ▶ Data always up-to-date
- ▶ Proven calculation methodology - more accurate and efficient designs
- ▶ Flexible catchment design
- ▶ Integrated rainfall data
- ▶ Automated product optimisation
- ▶ PDF summary documents



**Register Now - It's Free**

[www.aco.co.uk/quad-hydraulic-design-2.0](http://www.aco.co.uk/quad-hydraulic-design-2.0)

\*Not suitable for carriageways of public roads or motorways



# ACO MultiDrain® MD range layout

To support a wide variety of catchment depths, hydraulic capacities and applications, the system is available in three channel widths, 100mm, 150mm and 200mm and has a range of constant depths, shallow depth and sloping depth channels to suit the drainage design.

The layout below illustrates the channels and accessories available within the ACO MultiDrain® MD range and to aid product selection, a summary of the function and feature of each component is provided.

All ACO MultiDrain® MD channels can be purchased with galvanised or stainless steel edge rails.

Further details can be found on pages 13 – 37 of this brochure.

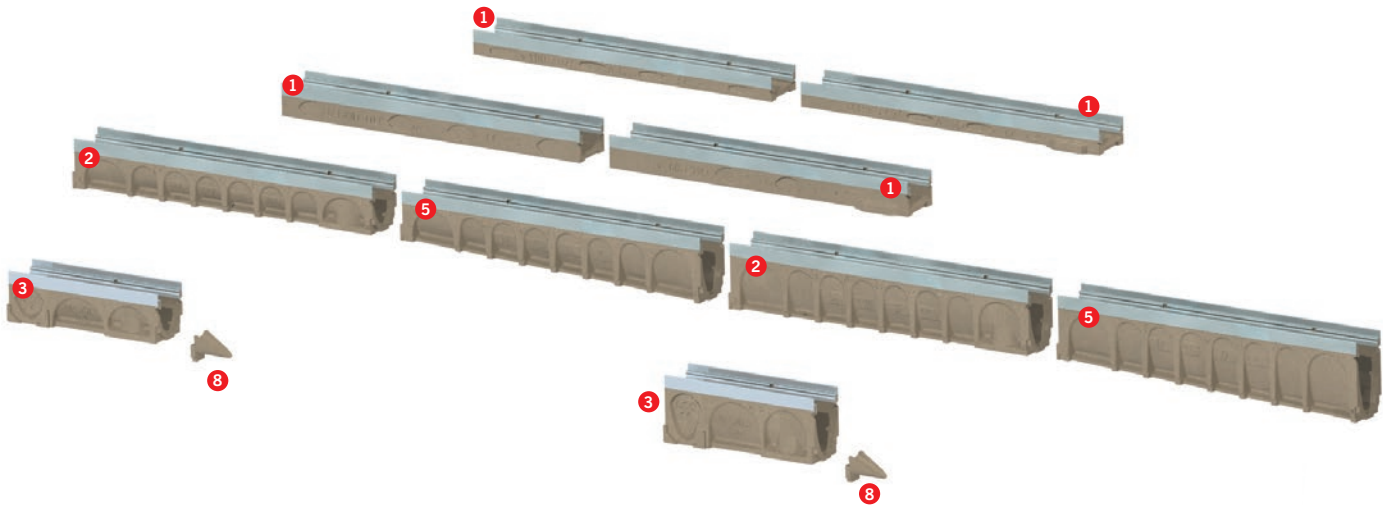

## 1 Shallow depth channels

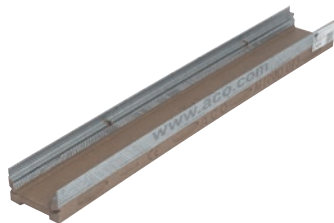

- ▶ **100mm wide bore:** Four shallow channel units are available in 1m lengths with an overall depth of 75mm or 100mm.
- ▶ **150mm wide bore:** One shallow channel unit is available in 1m length with an overall depth of 100mm.
- ▶ **200mm wide bore:** One shallow channel unit is available in 1m lengths with an overall depth of 100mm.

Standard option available includes vertical cast-in TPE seal for connection to Ø110mm pipework.

## 2 Constant depth channels



- ▶ **100mm wide bore:** Four constant depth channel units are available in 1m lengths with overall depths ranging from 150mm to 300mm.
- ▶ **150mm wide bore:** Three constant depth channel units are available in 1m lengths with overall depths ranging from 210mm to 310mm.
- ▶ **200mm wide bore:** Three constant depth channel units are available in 1m lengths with overall depths ranging from 265mm to 365mm.

These channels include a vertical knockout for connection to Ø110mm (100mm wide bore channels) or Ø160mm (150mm and 200mm wide bore channels) pipework.

## 3 Constant depth channels – 0.5m



- ▶ **100mm wide bore:** Four 0.5m constant depth channel units are available with overall depths ranging from 150mm to 300mm.
- ▶ **150mm wide bore:** Three 0.5m constant depth channels with overall depths ranging from 210mm to 310mm.
- ▶ **200mm wide bore:** Three 0.5m constant depth channels with overall depths ranging from 265mm to 365mm.

These channels include vertical knockout for connection to Ø110mm (100mm wide bore) or Ø160mm (150mm and 200mm wide bore) pipework and side knockout for 90° channel connections.

**4 Universal Sump**



Each system width has one 0.5m universal sump for connection to all channels. Outlet options for Ø110mm and Ø160mm pipes and foul air traps. Plastic silt bucket provided with each unit.

**5 Sloping depth channels**



▶ **100mm wide bore:** Twenty 1m sloping channels with 0.5% fall in depths from 150mm to 250mm.

**6 Universal Gully**



One universal gully for all applications and channel widths from Load Class A 15 to D 400. Standard features include ductile cast iron cover, silt bucket and roddable foul air trap for connection to Ø160mm PVC-U pipe.

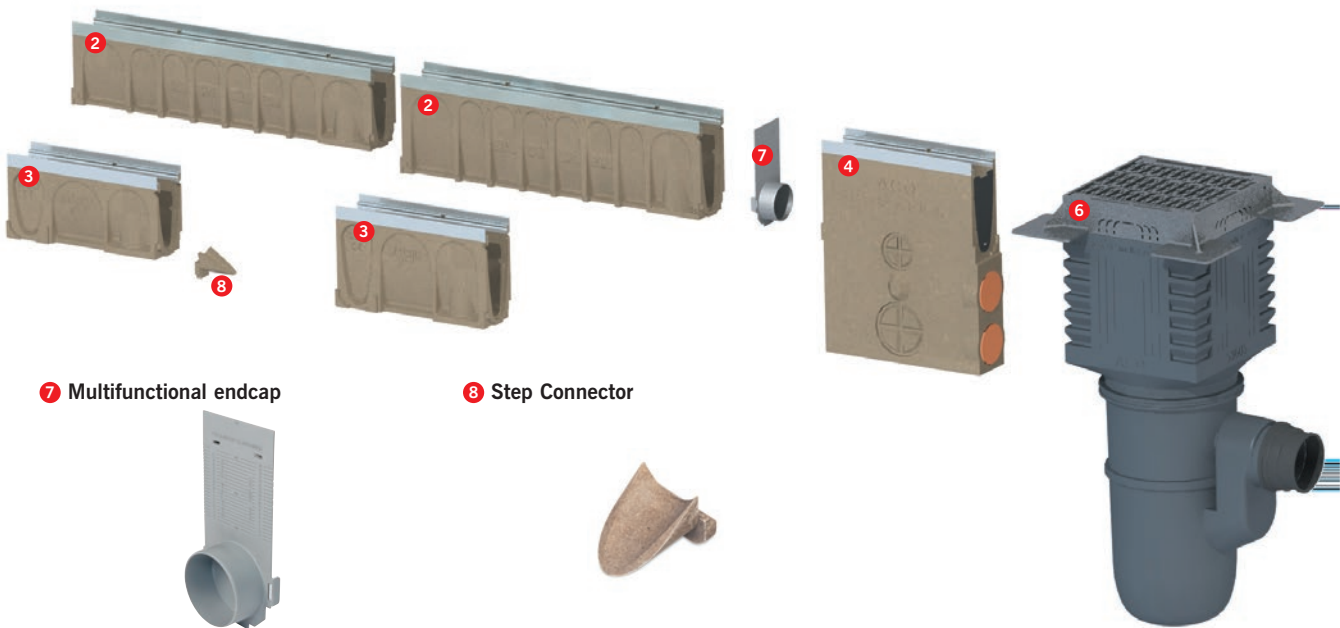

**7 Multifunctional endcap**



One plastic universal endcap for each channel width. Provides a closing or outlet option to Ø110mm (100mm wide bore channels) or Ø160mm (150mm and 200mm wide bore channels) pipes.

**8 Step Connector**



A polymer concrete unit which helps provide smooth water transition between constant depth channels when used in a stepped system design. The step connector is suitable for the 50mm step between each of the constant channel depths.

**Guidance for using the ACO MultiDrain® MD parts tables**

The ACO MultiDrain® MD parts tables are shown on the following pages. The product information is split down by channels widths and further by channel depth and edge rail type. This is to enable quick and simple product identification and selection.

The tables for ACO MultiDrain® MD channels list a number associated with the Invert Type. This number highlights the drainage design which can be achieved when using these channels. The key for the Invert Type is shown opposite.

**Channel invert types**

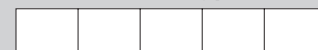

1 Constant Depth Invert

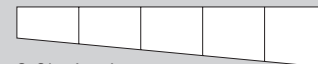

2 Sloping Invert



3 Stepped Invert

ACO MULTIDRAIN® FEATURES OVERVIEW



Anti shunt feature holds grating securely in place



ACO Drainlock™ gratings - this bar-less locking device improves hydraulic capacity and provides for quick and simple installation of gratings

Sealant groove for simple watertight installations

V shaped channel bore improves speed of water flow and promotes self cleansing

Male and female channel connections to aid fast installation.

Improved knockout for connection to Ø110mm (for M100D channels) and Ø160mm (for M150D and M200D channels) PVC-U pipes.



8  
■■■

LOAD CLASSES



**A 15**  
Pedestrian, cycleways, minimally trafficked areas (light domestic vehicles only).



**B 125**  
Pedestrian precincts, light vehicles, private car parks and drives.



**C 250**  
Parking areas, service stations (cars) and slow-moving light commercial vehicles.



**D 400**  
Parking areas for all types of vehicles\*

\* Not suitable for carriageways of public roads or motorways.



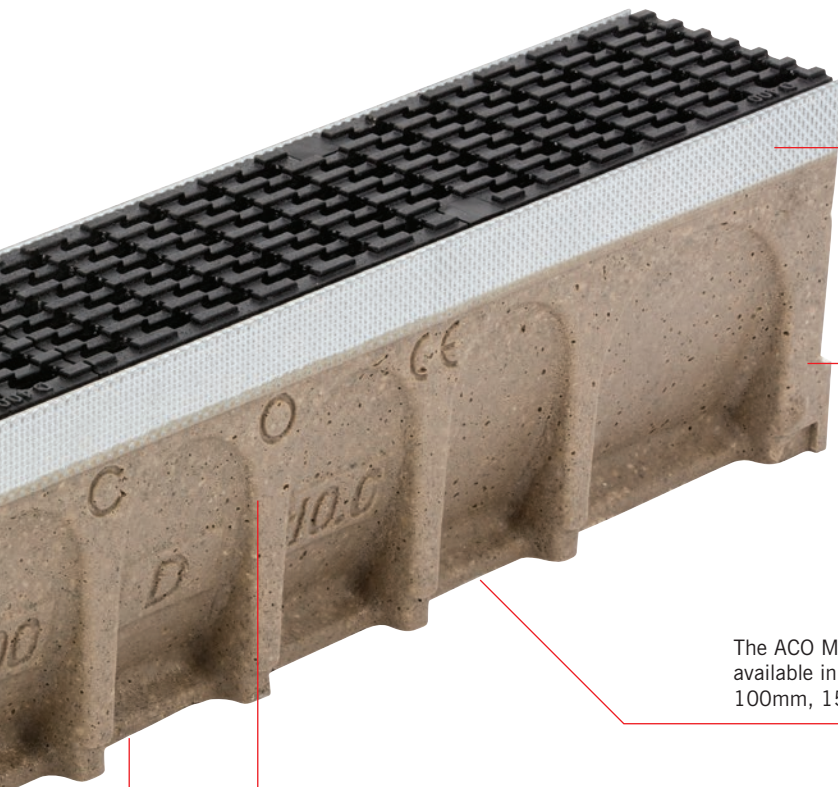

Protective UltraSTEEL™ galvanised edge rails for improved strength and bonding between channel and surface materials. Also available in stainless steel.

Manufactured from Vienite®, a polymeric based recycled material, strong and lightweight design, improves stability and anchors product into concrete surround.



The ACO MultiDrain® MD system is available in three channel widths; 100mm, 150mm and 200mm.

Parking areas for all types of vehicles\*

Internal channel marking for easy identification once installed.

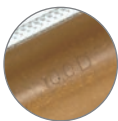

**Gratings**

ACO MultiDrain® MD System has a wide variety of gratings available that include cast iron, stainless steel and plastic slotted gratings, heelguard options (including the new ATec coated heelguard grating), solid covers and brickslot gratings. See pages 10 to 12 for further details.

# EXPLORE THE WORLD'S LARGEST RANGE OF GRATING STYLES

Style, aesthetics, performance and reliability are all important factors when specifying surface water management systems. Globally recognised as the no. 1 choice in managing surface water, ACO provide designers with the widest range of channel and grating styles to choose from.

By using a range of different design options including light, form, texture, material and colour, ACO's grating and channel styles can be used to complement or enhance many landscape designs.

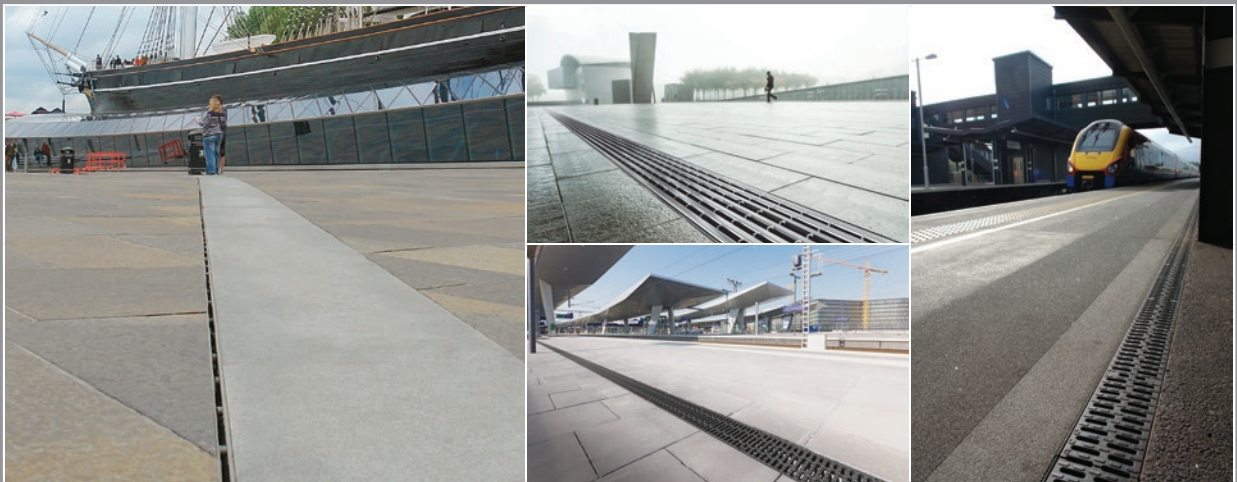

## Multi applications provided for by ACO MultiDrain® MD

The breadth of the ACO MultiDrain® grating range provides designers with a wide choice of styles to complete their surface water drainage system.

Depending on the application requirement, Architects, Designers and Planners can choose from variety of popular, long establish designs in ductile iron, high tech composites, galvanised or stainless steel materials.

For applications which require discreet drainage to blend subtly with the design of the landscape, ACO Brickslot can provide an aesthetically-pleasing finish.

Supplied as standard with ACO Drainlock™ boltless locking, the range of grating styles is available in load classes A 15 – D 400 making them the idea choice for both pedestrian and vehicular applications.

To suit a range of hydraulic requirements, these grating styles are available for use with 100mm, 150mm and 200mm wide channels.



Technical information for these gratings is provided on page 15 onwards



## Lighting & bespoke solutions

### Lighting Solutions

Enhance and add definition to a space - see ACO Lighting Systems brochure for details.

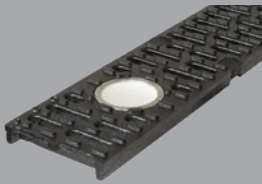

### Bespoke Slot Solutions

Our Brickslot gratings can be provided in a range of bespoke heights and widths. Contact our Design Services Team for details.

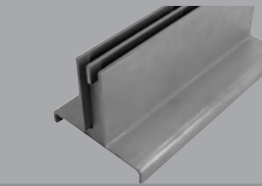

### Bespoke Freestyle Solutions

Realise your own design ideas. ACO Freestyle cast iron gratings offer you individual solutions for every project. Contact our design services team for more details.

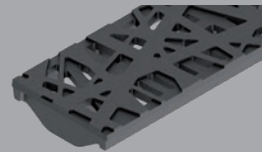

## Surface + Grating Visualiser

A clever, yet easy to use software program that visualises how our range of grating designs could enhance your project.



To make specification easier, the software will suggest our most suitable ranges based on the project requirements. You can then select from the available options and visualise how these may look in different surface finishes. Once a choice is made, a simple, yet detailed specification sheet provides full product information.



To launch the visualiser scan the QR code or visit [www.aco.co.uk/gratingvisualiser](http://www.aco.co.uk/gratingvisualiser)

## New grating styles

A new range of contemporary, elegant designs will add character and style to any landscape project.

### Intercept Profile Stainless steel



High quality linear profile design provides a contemporary, long lasting finish to any prestigious landscaping project.

### Intercept Profile Galvanised steel

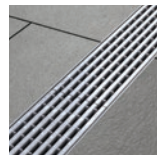

High quality linear profile design provides a stylish option for those looking for an alternative to stainless steel.

### Intercept Bar



The sleek and elegant intercept bar design provides a classic, high end finish to any project.

### Mosaic



The unique pattern of the Mosaic design provides an ideal finish to heritage or traditional landscapes.

### Intercept

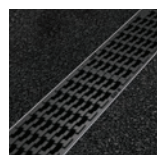

The Intercept D400 grating provides a minimalist and widely appealing design.

### Flag



The unusual character of the Flag design provides a fun alternative to traditional slotted gratings.

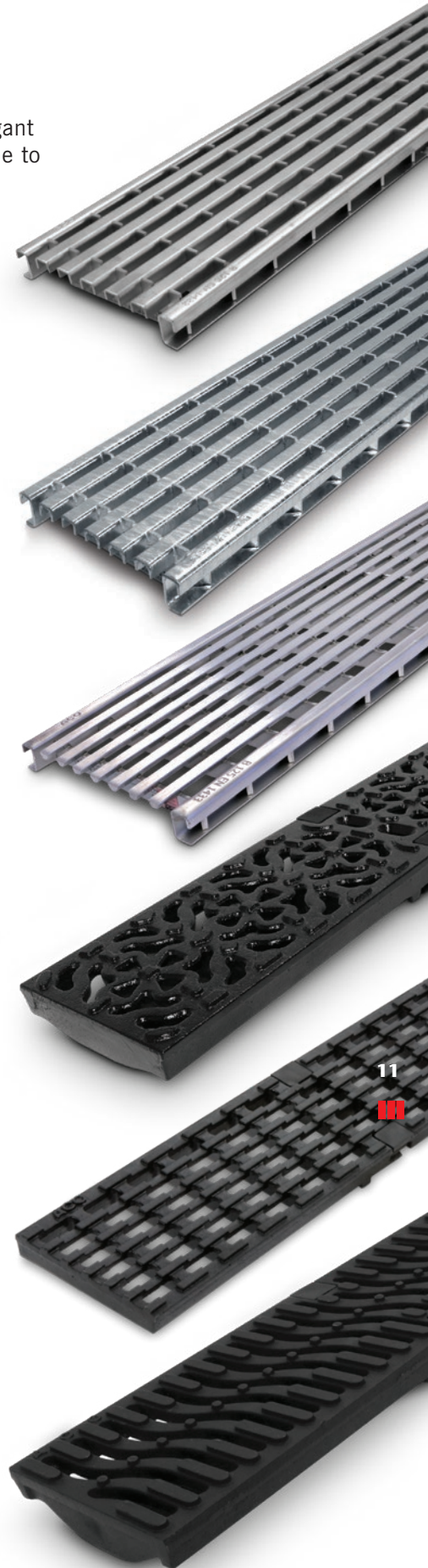

# Surface design detail

## Creating bespoke gratings

MultiDrain MD channels are compatible with a wide range of grating designs including a new bespoke grating service from ACO.

## Introducing the new ACO Freestyle

The ACO Freestyle offering is a unique customer-led grating design solution, which gives you the freedom to create fully bespoke drainage grating designs for the external environment.

## Who is Freestyle for?

Freestyle is relevant for clients who value first impressions – which starts with the approach to the building.

It is for clients who value something new being brought to the table and bespoke drainage gratings are something most clients have not considered. When looking at pedestrian areas with quality paving solutions, Freestyle is a complimentary and functional aesthetic solution.

Clients, who value branding opportunities, will appreciate the possibilities of incorporating their logo into the grating design.

Freestyle also works for those clients who are aiming for a traditional standing or wish to integrate into a historic setting, as the flowing forms of metal translate well when recreating Victorian grandeur.



- ▶ Inspiration can come from many different sources. Your building or landscape may naturally inspire or suggest particular designs. Alternatively you could look towards abstract shapes and patterns to inspire you.
- ▶ With customer design at the heart of the offering, ACO Freestyle begins with a design being submitted to ACO, who then create a design model from this template. Templates are available to download from the ACO website [www.aco.co.uk/freestyle](http://www.aco.co.uk/freestyle) to help in this process.
- ▶ The Freestyle grating is overlaid on a grid design that has been tested for a Load class up to D400, which matches the load class strength of Multiline Sealin channels.
- ▶ With the option to access a number of pre-moulded designs, as well as create something completely unique, which ACO will manufacture for you, Freestyle allows greater creative control of the external landscape.



ACO. The future of drainage.

Download your brochure + design templates: [www.aco.co.uk/freestyle](http://www.aco.co.uk/freestyle)



# ACO MultiDrain® M100D channels with UltraSTEEL™ galvanised edge rails.

ACO MultiDrain® M100D channels are manufactured from Vienite®, ACO's sustainable high strength material, which provides high chemical resistance. The channels are available in constant depth, sloping depth and shallow depth units.

ACO MultiDrain® M100D channels listed below are provided with integral galvanised steel protective edge rails.

For enhanced durability these rails are manufactured from UltraSTEEL™, a unique material that has improved strength over plain steel.

The added benefit of UltraSTEEL™ is that its greater surface area improves the bond between rail and adjacent material where a sealed system is required.

For the ACO MultiDrain® M100D range of gratings to suit these channels please refer to pages 17 and 18.

## Constant and sloping depth channels with UltraSTEEL™ galvanised edge rails

Product code	Description	Length (mm)	Width overall (mm)	Depth overall (mm)	Invert depth (mm)	Invert Type	Weight (kg)
23075	M100D No. 075	1000	135	75	55	1	9.2
23076	M100D No. 075V	1000	135	75*	55	1	8.9
23110	M100D No. 0100	1000	135	100	80	1	11.0
23111	M100D No. 0100V	1000	135	100*	80	1	10.7
23000	M100D No. 0.0*	1000	135	150	130	1/3	12.9
23050	M100D No. 0.1J*	500	135	150	130	1/3	7.6
23001	M100D No. 1	1000	135	150/155	130/135	2	13.5
23002	M100D No. 2	1000	135	155/160	135/140	2	13.8
23003	M100D No. 3	1000	135	160/165	140/145	2	14.1
23004	M100D No. 4	1000	135	165/170	145/150	2	14.4
23005	M100D No. 5	1000	135	170/175	150/155	2	14.7
23006	M100D No. 6	1000	135	175/180	155/160	2	15.0
23007	M100D No. 7	1000	135	180/185	160/165	2	15.3
23008	M100D No. 8	1000	135	185/190	165/170	2	15.6
23009	M100D No. 9	1000	135	190/195	170/175	2	15.9
23010	M100D No.10	1000	135	195/200	175/180	2	16.2
23100	M100D No.10.0*	1000	135	200	180	1/3	15.9
23101	M100D No.10.1J*	500	135	200	180	1/3	9.2
23011	M100D No.11	1000	135	200/205	180/185	2	16.5
23012	M100D No.12	1000	135	205/210	185/190	2	16.8
23013	M100D No.13	1000	135	210/215	190/195	2	17.1
23014	M100D No.14	1000	135	215/220	195/200	2	17.4
23015	M100D No.15	1000	135	220/225	200/205	2	17.7
23016	M100D No.16	1000	135	225/230	205/210	2	18.0
23017	M100D No.17	1000	135	230/235	210/215	2	18.3
23018	M100D No.18	1000	135	235/240	215/220	2	18.6
23019	M100D No.19	1000	135	240/245	220/225	2	18.9
23020	M100D No.20	1000	135	245/250	225/230	2	19.2
23200	M100D No.20.0*	1000	135	250	230	1/3	21.8
23201	M100D No.20.1J*	500	135	250	230	1/3	10.8
23300	M100D No.30.0*	1000	135	300	280	1/3	25.4
23301	M100D No.30.1J*	500	135	300	280	1/3	12.5

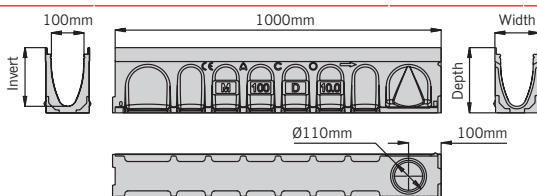

M100D 1m constant depth channel 0.0 to 30.0

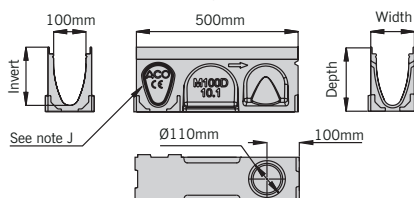

M100D 0.5m constant depth channel

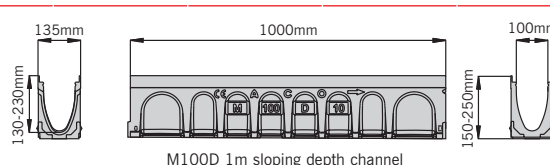

M100D 1m sloping depth channel

**Note:** The constant depth channels have an improved knockout feature, see page 41 for more information.

\* Indicates channels supplied with a preformed Ø110mm knockout for vertical outlet.

J Indicates side knockout for 90° channel connection. Knockout on both sides of the channel.



# ACO MultiDrain® MD components

## M150D Constant depth channels with UltraSTEEL™ galvanised edge rails

Product code	Description	Length (mm)	Width overall (mm)	Depth overall (mm)	Invert depth (mm)	Invert Type	Weight (kg)
23156	M150D No. 0100	1000	185	100	75	1	15.0
23157	M150D No. 0100V	1000	185	100	75	1	14.9
23150	M150D No. 0.0*	1000	185	210	185	1/3	23.4
23153	M150D No. 0.1J*	500	185	210	185	1/3	12.7
23151	M150D No.10.0*	1000	185	260	235	1/3	26.2
23154	M150D No. 10.1J*	500	185	260	235	1/3	14.6
23152	M150D No.20.0*	1000	185	310	285	1/3	30.3
23155	M150D No. 20.1J*	500	185	310	285	1/3	16.4

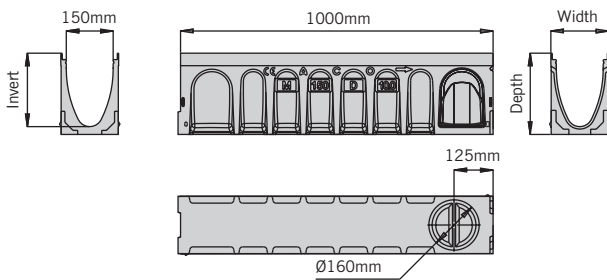

M150D 1m constant depth channel

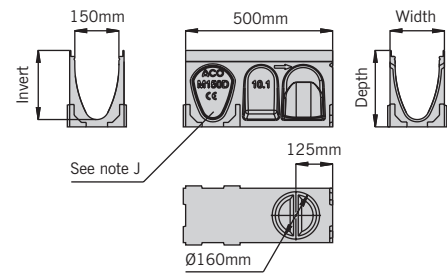

M150D 0.5m constant depth channel

## M200D Constant depth channels with UltraSTEEL™ galvanised edge rails

Product code	Description	Length (mm)	Width overall (mm)	Depth overall (mm)	Invert depth (mm)	Invert Type	Weight (kg)
23216	M200D No. 0100	1000	235	100	75	1	17.5
23217	M200D No. 0100V	1000	235	100	75	1	17.0
23210	M200D No. 0.0*	1000	235	265	240	1/3	33.0
23213	M200D No. 0.1J*	500	235	265	240	1/3	17.9
23211	M200D No.10.0*	1000	235	315	290	1/3	37.4
23214	M200D No. 10.1J*	500	235	315	290	1/3	19.9
23212	M200D No.20.0*	1000	235	365	340	1/3	40.4
23215	M200D No. 20.1J*	500	235	365	340	1/3	21.9

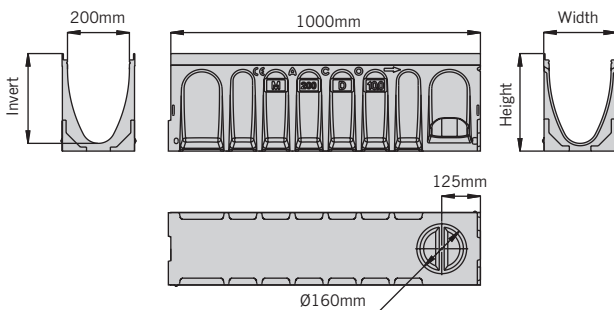

M200D 1m constant depth channel

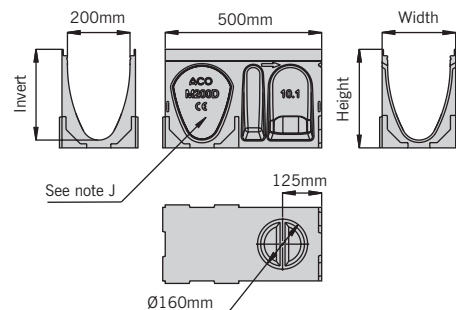

M200D 0.5m constant depth channel

Note: The constant depth channels have an improved knockout feature, see page 41 for more information.

\* Indicates channels supplied with a preformed Ø110mm knockout for vertical outlet.

J Indicates side knockout for 90° channel connection. Knockout on both sides of the channel.

V Indicates channel with cast in TPE triple lipped seals for water tight connection. See page 41 for further information.

† 075V and 0100V channels have a depth overall around the outlet of 80mm (075V) and 105 (0100V).

*These products are subject to weight and dimensional tolerances. The dimensions shown on this page are for guidance purposes only.*



## Multifunctional endcap (closing/inlet/outlet)

Product code	Description	Length (mm)	Width overall (mm)	Depth overall (mm)	Invert depth (mm)	Invert Type	Weight (kg)
23404	M100D No. 306 multifunctional endcap -	135	135	75/300	50	-	0.2
23159	M150D No. 306 multifunctional endcap -	185	185	310/100	75	-	0.3
23219	M200D No. 306 multifunctional endcap -	235	235	365/100	75	-	0.4

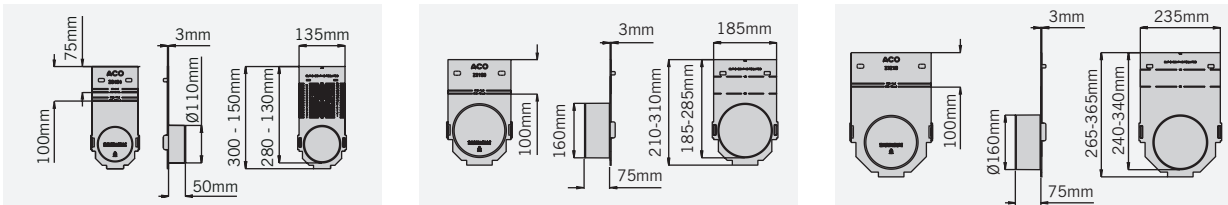

The multifunctional endcap can be cut down to suit all channels. See page 42 for further information.

## Step Connector

Product code	Description	Length (mm)	Width overall (mm)	Depth overall (mm)	Invert depth (mm)	Invert Type	Weight (kg)
12601	M100D 50mm step connector	100	75	50	-	-	0.4
13001	M150D 50mm Step connector	100	98	50	-	-	0.5
13401	M200D 50mm Step connector	100	120	50	-	-	0.6

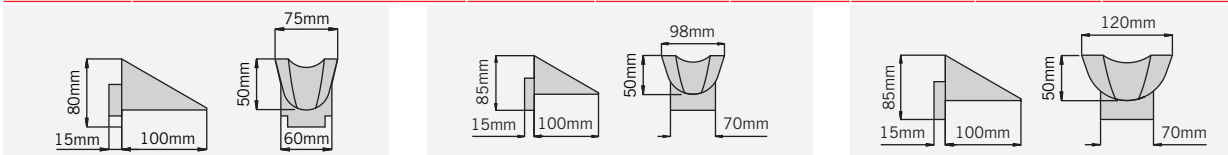

Note: For information on the step connector functionality see page 42.

## Universal gully and components

Product code	Description	Length (mm)	Width overall (mm)	Depth overall (mm)	Invert depth (mm)	Invert Type	Weight (kg)
33401	Gully assembly and bucket 601D	440	440	1315	870	-	52.5
33402	Gully assembly no bucket 602D	440	440	1315	870	-	51.0
33407	Gully top assembly 607D	440	440	655	-	-	45.0
33605	Gully base unit 605	-	Ø375	750	310	-	4.3
33603	Gully intermediate unit 603	440	440	515	-	-	5.1
44355	Gully grating and frame 600D	400*	564††	100	-	-	40.0
7060	Gully connector 615	500	Ø500	40	-	-	7.0
33606	Bucket polyethylene 606	-	Ø275	245	-	-	1.4

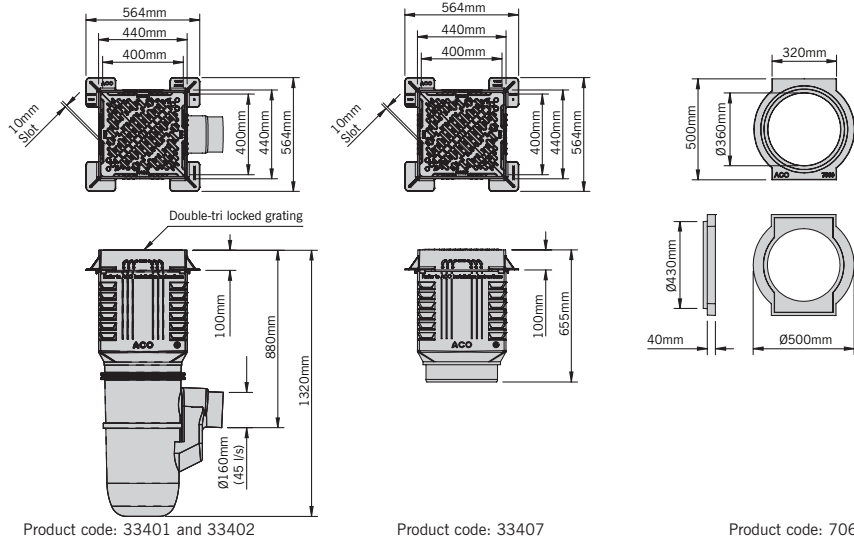

Note. Plain U-PVC 150mm - 160mm Supersleeve adaptor supplied with 601D, 602D and 605 assemblies. For information on universal gully functionality see page 43. \*Clear opening size. ††Over frame size.

These products are subject to weight and dimensional tolerances. The dimensions shown on this page are for guidance purposes only.



# ACO MultiDrain® MD components

## M100D sump unit with UltraSTEEL™ galvanised edge rails

Product code	Description	Length (mm)	Width overall (mm)	Depth overall (mm)	Invert depth (mm)	Invert Type	Weight (kg)
23410	M100D universal sump with plastic silt bucket	500	135	635	615	-	32.8

Standard sump outlets

- 1 = Ø110mm outlet with triple lipped seal
- 2 = Ø110mm knockout
- 3 = Ø160mm knockout

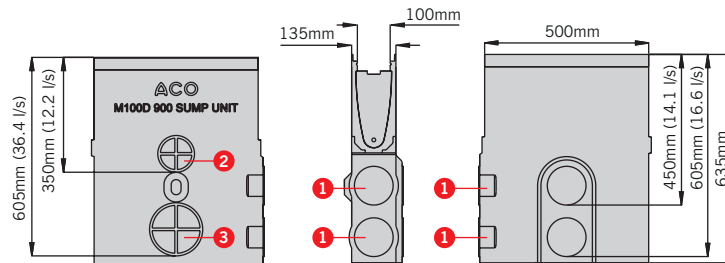

Note: Drawing shows flow through un-trapped unions. For information on the sump unit functionality see page 47.

## M150D sump unit with UltraSTEEL™ galvanised edge rails

Product code	Description	Length (mm)	Width overall (mm)	Depth overall (mm)	Invert depth (mm)	Invert Type	Weight (kg)
23158	M150D universal sump with plastic silt bucket	500	185	735	715	-	43.4

Standard sump outlets

- 1 = Ø110mm outlet with triple lipped seal
- 2 = Ø160mm outlet
- 3 = Ø200mm knockout

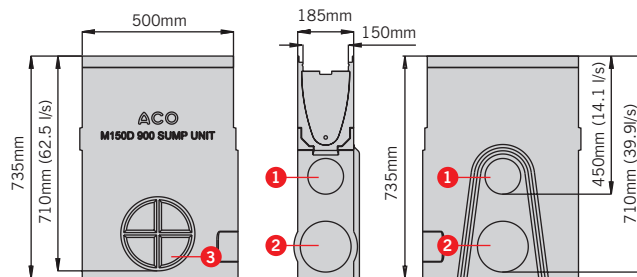

Note: Drawing shows flow through un-trapped unions. For information on the sump unit functionality see page 43.

## M200D sump unit with UltraSTEEL™ galvanised edge rails

Product code	Description	Length (mm)	Width overall (mm)	Depth overall (mm)	Invert depth (mm)	Invert Type	Weight (kg)
23218	M200D universal sump with plastic silt bucket	500	235	790	765	-	47.0

Standard sump outlets

- 1 = Ø110mm outlet with triple lipped seal
- 2 = Ø160mm outlet
- 3 = Ø200mm knockout

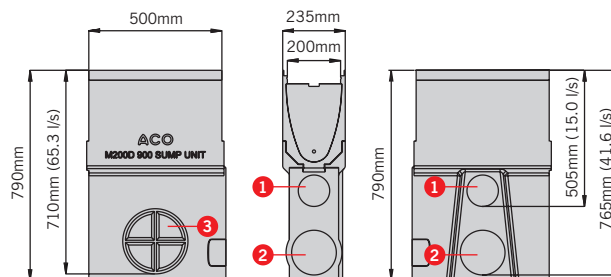

Note: Drawing shows flow through un-trapped unions. For information on the sump unit functionality see page 43.





## M100D Drain unions and foul air traps

Product code	Description	Length (mm)	Width overall (mm)	Depth overall (mm)	Invert depth (mm)	Invert Type	Weight (kg)
0056	820 Drain union PVC-U Ø110mm (max 16.6 l/s)	100	110	-	605	-	0.1
0058	822 Drain union PVC-U Ø160mm (max 36.4 l/s)	100	160	-	605	-	0.5
2640	920 Foul air trap PVC-U Ø110mm (max 12.2 l/s)	-	110	-	360	-	0.5
2638	922 Foul air trap PVC-U Ø160mm (max 25 l/s)	-	160	-	340	-	1.9
7931	940 Roddable foul air trap MDPE Ø110mm (max 14 l/s)	-	110	-	450	-	0.4
7932	950 Roddable foul air trap MDPE Ø160mm (max 29 l/s)	-	160	-	400	-	0.8

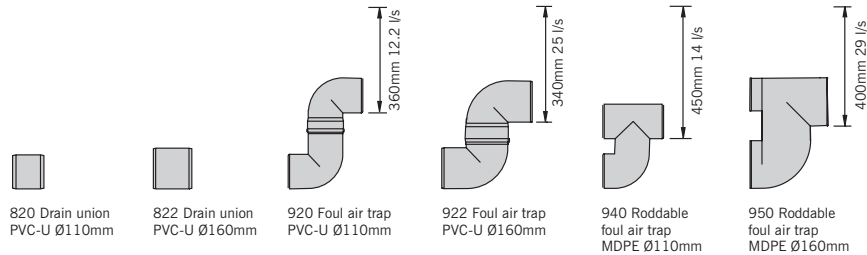

## M150D Drain unions and foul air traps

Product code	Description	Length (mm)	Width overall (mm)	Depth overall (mm)	Invert depth (mm)	Invert Type	Weight (kg)
0056	820 Drain union PVC-U Ø110mm (max 14.1 l/s)	100	110	-	450	-	0.1
0058	822 Drain union PVC-U Ø160mm (max 39.9 l/s)	100	160	-	710	-	0.5
2723	823 Drain Union PVC-U Ø200mm (max 69.5 l/s)	200	200	-	710	-	0.6
2638	922 Foul air trap PVC-U Ø160mm (max 31 l/s)	-	160	-	445	-	1.9
7932	950 Roddable foul air trap MDPE Ø160mm (max 32 l/s)	-	160	-	505	-	0.8

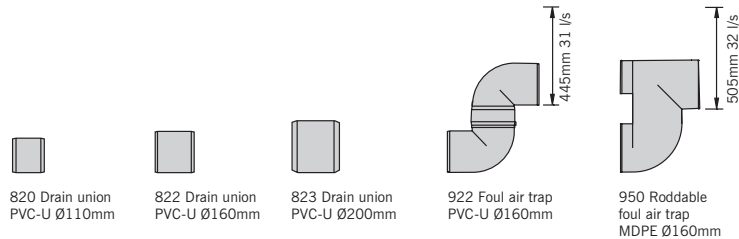

## M200D Drain unions and foul air traps

Product code	Description	Length (mm)	Width overall (mm)	Depth overall (mm)	Invert depth (mm)	Invert Type	Weight (kg)
0056	820 Drain union PVC-U Ø110mm (max 15.0 l/s)	100	110	-	505	-	0.1
0058	822 Drain union PVC-U Ø160mm (max 41.6 l/s)	100	160	-	765	-	0.5
2723	823 Drain Union PVC-U Ø200mm (max 72 l/s)	200	200	-	765	-	0.6
2638	922 Foul air trap PVC-U Ø160mm (max 32 l/s)	-	160	-	500	-	1.9
7932	950 Roddable foul air trap MDPE Ø160mm (max 34 l/s)	-	160	-	560	-	0.8

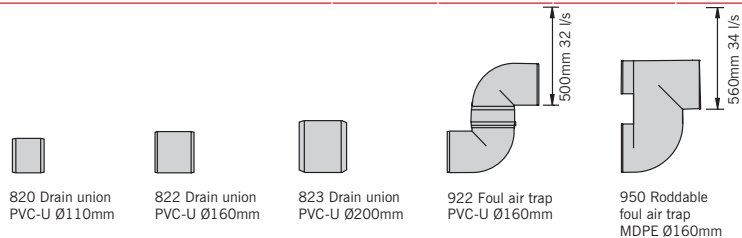

## Accessories

Product code	Description	Weight (kg)
32599	Polymer concrete repair kit	1.0†



†Repair kit includes 0.5kg tin of natural colour polyester concrete repair resin, grey and black pigment, hardener paste, mixing instructions and material safety data sheets.



## Problem solving drainage solutions: Discreet slot drainage



### ACO MULTIDRAIN MD BRICKSLOT



Galvanised steel



Stainless steel



Access units



Load Class

ACO MultiDrain® MD has a range of gratings to complement installations which require discreet slot drainage.

Designed with a heelguard 10mm single offset drainage inlet, or a double Twinslot inlet in either offset or central. ACO Brickslot is a subtle and unobtrusive grating which when combined with an ACO MultiDrain® MD channel, can be used as a solution to complement discreet drainage applications and is ideal for use against buildings facades.

Compatible with most paving materials, the vertical sides of the grating enable pavements to be laid directly to the unit's edge. Once installed the system is totally secure and not vulnerable to vandalism or loose grates making it a suitable for applications such as schools and playgrounds where grating removal can become a hazard.

The channel and ACO Brickslot grating together provide an unobtrusive continuous slot drainage system, with high hydraulic efficiency for fast removal of surface water. ACO Brickslot gratings are available in galvanised or stainless steel and suitable for use with the 100mm, 150mm and 200mm wide channels in the ACO MultiDrain® MD range.

The system includes an ACO Brickslot access unit to ensure easy maintenance and access to the drainage system, and is also fully compatible with the range of ACO MultiDrain® MD accessories.

The system is suitable for applications up to and including Load Class D400 (This product is not suitable for carriageways of public roads or motorways).

### Applications

- Threshold drainage
- Public landscaping
- Car parking
- Light industrial
- HGV parking
- Petrol station forecourts
- SuDS



#### Bespoke Brickslot

ACO Bespoke Brickslot is custom designed to suit specific customer requirements for MultiDrain 100, 150 and 200 channels. To accommodate specific sites, ACO Brickslot grates can be manufactured in different heights (30mm to 200mm) and also custom slot widths and lengths (up to 1m). The Brickslot can be manufactured from mild steel with a hot dipped galvanised finish or stainless steel for increased corrosion resistance. Please contact your sales representative to discuss.

# Discreet slot drainage gratings

The ACO Brickslot grating system has an access unit for easy maintenance and cleaning of the drainage system.

The access unit is positioned within the channel; it has a removable tray section which is lifted out of the frame by a lifting tool to gain access to the system.

The access unit is 0.5m in length and is available in the galvanised and stainless steel finishes and is suitable for use with any ACO MultiDrain® M100D/M100DS, M150D/M150DS and M200D/M200DS wide channels.

The unit has a heelguard 10mm off set drainage inlet, providing continuous aesthetic and drainage performance once installed with the drainage system.

The ACO Brickslot access units are sold separately to the channel units. For information on the ACO MultiDrain® M100D/M100DS, M150D/M150DS and M200D/M200DS wide channels. Please refer to pages 13/14 and 28/29.

## Removal instructions.

To remove the ACO Brickslot access unit tray, insert the lifting tools as shown in figure 1. Then lift the tray vertically from the frame (figure 2). Details on the lifting tools can be found on page 18.



Figure 1



Figure 2

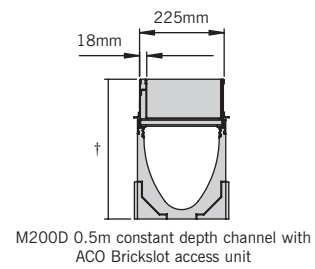
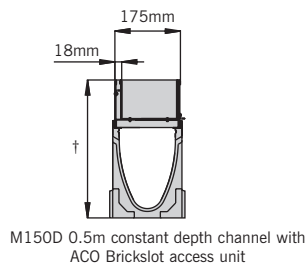
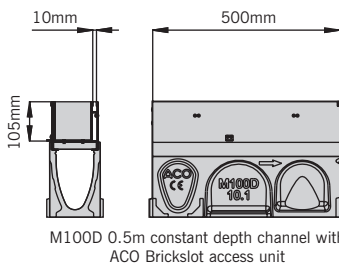

ACO Brickslot is available in two styles, single brickslot and twinslot. The location of the slot is commonly positioned offset to the centre of the channel, which allows the system to be installed discretely against building façades.

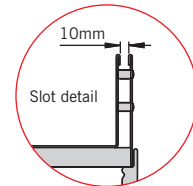

Brickslot Single - Offset

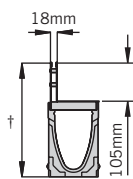

Brickslot Twinslot - Offset

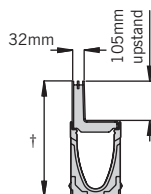

Brickslot Twinslot - Central

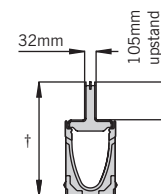
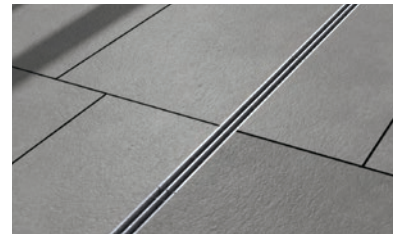

**Note:** To obtain the overall height (marked †) add 105mm to the overall channel depth. The overall depth of each channel can be found in the channel tables in this brochure.  
\*Not suitable for carriageways of public roads or motorways.



## New Intercept grate: Minimalism for maximum water interception

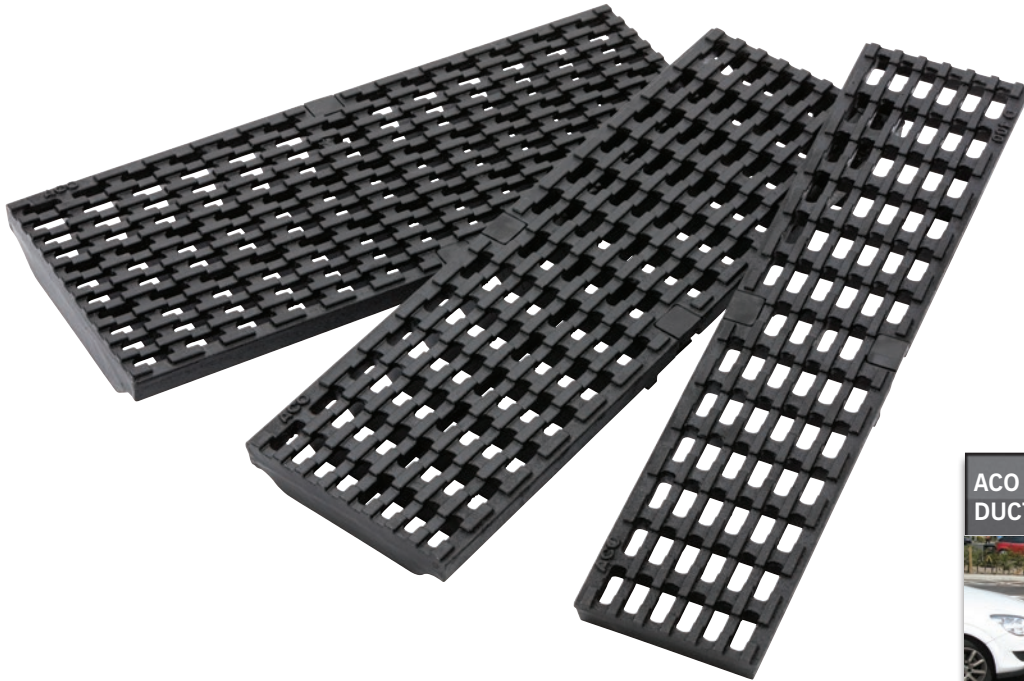

**ACO INTERCEPT  
DUCTILE IRON GRATE**

	Ductile iron
	Heelguard
	High water interception
	Load Class

ACO MultiDrain® MD has a new range of grates which encompass the principles of minimalist design. ACO Intercept ductile iron grates have clean lines and form, and meets the minimalist mantra of “Design stripped down to only its essential elements”

This grate has been designed to have superior water interception capabilities, and whilst it is functional it also achieves the goal of wide visual appeal.

James Canney, R&D Development Manager says “During the grates’ development we focused on achieving high level aesthetics and a sleek universal appeal. The ‘less is more’ approach to minimalistic design suits drainage grates, as it is important to have properly designed inlets for water to effectively enter the channel. The Intercept design combines functionality with timeless good looks”

ACO Intercept ductile iron grates are available in three widths and compatible with MultiDrain MD/PPD and Sealin channels.

They incorporate our unique ACO Drainlock™ fixings which improves hydraulic capacity of the channel

Combined with ACO MultiDrain® MD channels the system is suitable for applications up to and including Load Class D400 (This product is not suitable for carriageways of public roads or motorways).

### Applications

- Public landscaping
- Car parking
- Light industrial
- HGV parking
- SuDS



# Gratings for use with ACO MultiDrain® M100D channels with UltraSTEEL™ galvanised edge rails.



## Gratings for Load Class A 15 applications

Product code	Description	Length (mm)	Width overall (mm)	Depth overall (mm)	Slot width /hole dia (mm)	Heelguard™	Intake area (mm²/m)	Anti shunt feature	Weight (kg)
12610	Slotted galvanised steel 400DL	1000	123	21	10	Yes	25300	n/a	2.0
12611	Slotted galvanised steel 402DL	500	123	21	10	Yes	25300	n/a	1.0
12666	Perforated galvanised steel 12666DL	1000	123	21	6	Yes	16300	n/a	2.6
12667	Perforated galvanised steel 12667DL	500	123	21	6	Yes	16300	n/a	1.3



400DL / 402DL  
Slotted galvanised steel

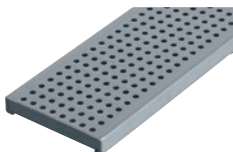

12666DL / 12667DL  
Perforated galvanised steel



## Gratings for Load Class B 125 applications

Product code	Description	Length (mm)	Width overall (mm)	Depth overall (mm)	Slot width /hole dia (mm)	Heelguard™	Intake area (mm²/m)	Anti shunt feature	Weight (kg)
132555	Intercept Profile galvanised steel 132555DL <b>6</b>	1000	123	21	29 x 8	Yes	44500	Yes	4.1
132550	Intercept Profile galvanised steel 132550DL <b>6</b>	500	123	21	29 x 8	Yes	44500	Yes	2.0



132555DL / 132550DL  
Intercept Profile galvanised steel



## Gratings for Load Class C 250 applications

Product code	Description	Length (mm)	Width overall (mm)	Depth overall (mm)	Slot width /hole dia (mm)	Heelguard™	Intake area (mm²/m)	Anti shunt feature	Weight (kg)
132720	Heelguard™ composite - black 522DL	500	123	21	8	Yes	28500	Yes	1.0
12673	Intercept ductile iron 507DL*	<b>6</b> 500	123	21	31 x 12	No	40100	Yes	3.7
12614	Slotted galvanised steel 423DL	1000	123	21	10	Yes	25300	n/a	5.0
12615	Slotted galvanised steel 424DL	500	123	21	10	Yes	25300	n/a	2.5
12656	Perforated galvanised steel 12656DL	1000	123	21	6	Yes	16300	n/a	4.8
12657	Perforated galvanised steel 12657DL	500	123	21	6	Yes	16300	n/a	2.4
132880	Heelguard™ mesh galvanised steel grating 410DL	1000	123	21	29 x 9.5	Yes	80000	Yes	4.2
132881	Heelguard™ mesh galvanised steel grating 412DL <b>6</b>	500	123	21	29 x 9.5	Yes	80000	Yes	2.1
23460	Brickslot single slot offset galvanised steel 23460 <b>6</b>	1000	123	105	10	Yes	10000	n/a	6.6
23461	Brickslot single slot offset galvanised steel 23461	500	123	105	10	Yes	10000	n/a	3.4
23462	Brickslot single slot offset access unit galvanised steel 23462	500	123	105	10	Yes	10000	n/a	6.6



522DL  
Heelguard™ composite

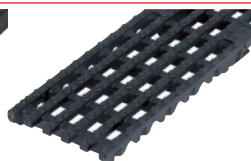

507DL  
Intercept ductile iron\*

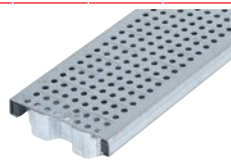

12656DL / 12657DL  
Perforated galvanised steel

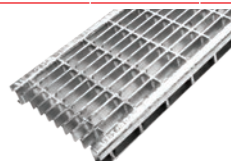

410DL / 412DL  
Mesh galvanised steel

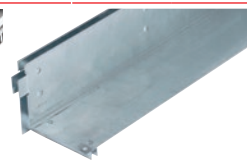

23460 / 23461  
Brickslot galvanised steel  
single slot

**6** Indicates security locking available.

\*Intercept ductile iron C250 grate is the original design, and differs aesthetically to the new D400 version



# Gratings for use with ACO MultiDrain® M100D channels with UltraSTEEL™ galvanised edge rails.



## Gratings for Load Class D 400\* applications

Product code	Description	Length (mm)	Width overall (mm)	Depth overall (mm)	Slot width /hole dia (mm)	Heelguard™	Intake area (mm²/m)	Anti shunt feature	Weight (kg)
23405	Heelguard™ ductile iron 23405DL <b>6</b>	500	123	21	8	Yes	23900	Yes	4.1
23510	Heelguard™ Intercept ductile iron 23510DL	500	123	21	10	Yes	41400	Yes	3.7
23406	Ductile iron solid cover 23406DL	500	123	21	n/a	No	n/a	Yes	4.5
23408	Slotted ductile iron 23408DL	500	123	21	12	No	35700	Yes	3.8
132042	Flag ductile iron 132042DL	500	123	21	8	Yes	30400	Yes	4.9
132043	Leaf ductile iron 132043DL	500	123	21	10	Yes	34700	Yes	4.7
132885	Heelguard™ mesh galvanised steel 132885DL <b>6</b>	1000	123	21	28 x 8.5	Yes	69100	Yes	5.1
132886	Heelguard™ mesh galvanised steel 132886DL <b>6</b>	500	123	21	28 x 8.5	Yes	69100	Yes	2.5
23460	Brickslot single slot offset galvanised steel 23460	1000	123	105	10	Yes	10000	n/a	6.6
23461	Brickslot single slot offset galvanised steel 23461	500	123	105	10	Yes	10000	n/a	3.4
23462	Brickslot single slot offset access unit galvanised steel 23462								
23465	Brickslot single slot offset galvanised steel 23465	1000	123	105	10	Yes	10000	n/a	6.7
23466	Brickslot single slot offset galvanised steel 23466	500	123	105	10	Yes	10000	n/a	3.4
23467	Brickslot single slot offset access unit galvanised steel 23467	500	123	105	10	Yes	10000	n/a	6.4
23480	Brickslot Twinslot offset galvanised steel	1000	123	105	10 (x2)	Yes	20000	Yes	12.9
23481	Brickslot Twinslot offset galvanised steel	500	123	105	10 (x2)	Yes	20000	Yes	6.1
23482	Brickslot Twinslot offset access unit galvanised steel	500	123	105	10 (x2)	Yes	20000	Yes	8.1
23483	Brickslot Twinslot central galvanised steel	1000	123	105	10 (x2)	Yes	20000	Yes	12.5
23484	Brickslot Twinslot central galvanised steel	500	123	105	10 (x2)	Yes	20000	Yes	7.0
23485	Twinslot central access unit galvanised steel	500	123	105	10 (x2)	Yes	20000	Yes	8.2

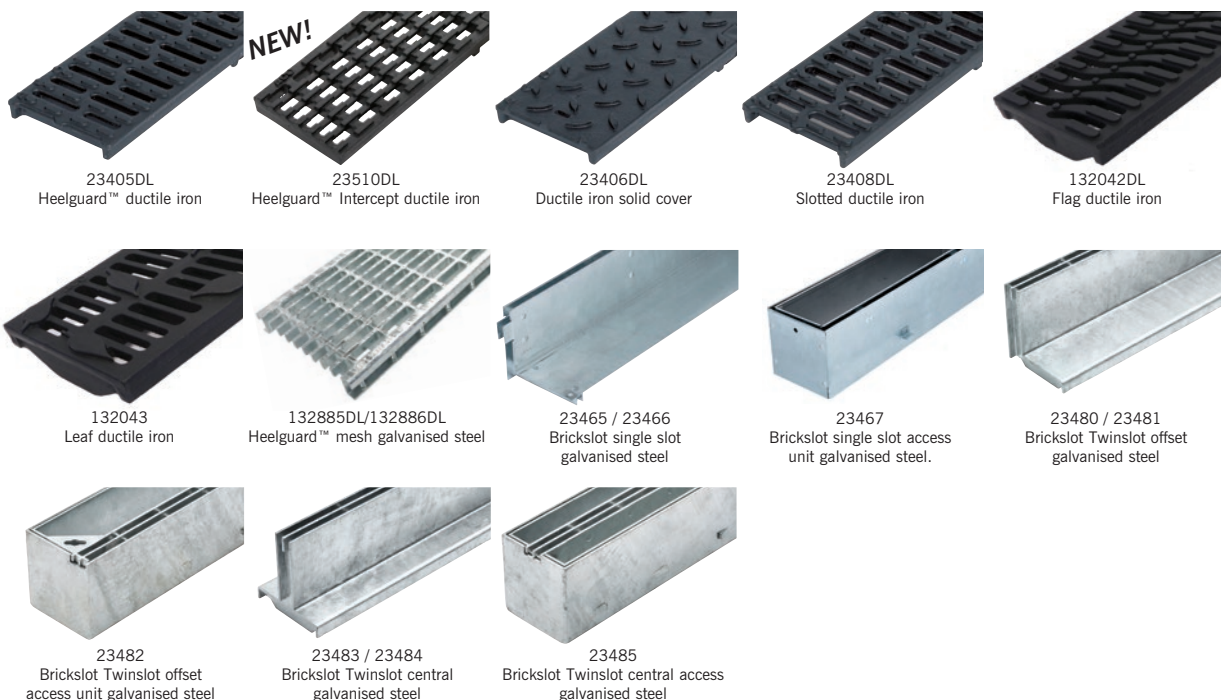

\*Not suitable for carriageways of public roads or motorways



## ACO ATec high performance finish



### Gratings for Load Class D 400\* applications with ACO ATec corrosion resistant coating

Product code	Description	Length (mm)	Width overall (mm)	Depth overall (mm)	Slot width /hole dia (mm)	Intake area (mm <sup>2</sup> /m)	Anti shunt feature	Weight (kg)
23409	ATec coated Heelguard™ ductile iron 23409DL	500	123	21	8	23900	Yes	4.1
23417	ATec coated Mosaic ductile iron 23417DL	500	123	21	10	28000	Yes	4.1



23409DL  
Heelguard™ ductile iron



23417  
Mosaic ductile iron



ACO ATec coating is a high performance finish that provides a superior resistance to corrosion. The electrochemically applied finish is strong and durable, making maintenance easier than on water-based surface coatings. The ATec finish also enhances long term durability in demanding environments and is particularly well suited for low trafficked areas. Please download our ATec datasheet for more informaton.

### Grating accessories

Product code	Description	For use with	Length (mm)	Width overall (mm)	Depth overall (mm)	Weight (kg)
23415	Drainlock™ security locking assembly	132720, 23405, 23409, 23417	96	20	13	0.1
445828	Drainlock™ security locking assembly Mesh B125 & C250**	132880, 132881	96	27	13	0.07
445745	Drainlock™ security locking assembly Mesh D400**	132885, 132886	96	27	13	0.06
445830	Drainlock™ security locking assembly Profile**	132555, 132550	96	27	13	0.06
23416	Drainlock™ security key	all	75	30	3	0.01
1367	Drainlock™ grating lifting tool	all	400	150	6	0.2



23415  
Drainlock™ security locking assembly



445828  
Drainlock™ security locking assembly  
Mesh B125 & C250\*



445745  
Drainlock™ security locking  
assembly Mesh D400\*



445830  
Drainlock™ security locking  
assembly Profile\*



23416  
Drainlock security key



1367  
Drainlock™ grating lifting tool 835

Indicates security locking available.

\*Not suitable for carriageways of public roads or motorways

\*\*Security key 23416 not compatible, allen key required

Note: 1m grates require 2pcs of Security locking assemblies and 0.5m grates require 1pc



# Gratings for use with ACO MultiDrain® M150D channels with UltraSTEEL™ galvanised edge rail



## Gratings for Load Class B 125 applications

Product code	Description	Length (mm)	Width overall (mm)	Depth overall (mm)	Slot width /hole dia (mm)	Heelguard™	Intake area (mm²/m)	Anti shunt feature	Weight (kg)
133601	Heelguard™ mesh galvanised steel 133601DL	1000	173	36	29 x 10	Yes	118200	Yes	5.4
133602	Heelguard™ mesh galvanised steel 133602DL	500	173	36	29 x 10	Yes	118200	Yes	2.7
133625	Intercept-Profile galvanised steel 133625DL	1000	173	30	29 x 9	Yes	68700	Yes	5.0
133626	Intercept-Profile galvanised steel 133626DL	500	173	30	29 x 9	Yes	68700	Yes	2.5

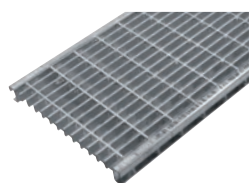

133601DL / 133602DL  
Heelguard™ mesh galvanised steel



133625DL / 133626DL  
Intercept-Profile galvanised steel



## Gratings for Load Class C 250 applications

Product code	Description	Length (mm)	Width overall (mm)	Depth overall (mm)	Slot width /hole dia (mm)	Heelguard™	Intake area (mm²/m)	Anti shunt feature	Weight (kg)
13073	Intercept ductile iron 13073DL**	500	173	21	30 x 12	No	59500	Yes	5.3
133605	Heelguard™ mesh galvanised steel 133605DL	1000	173	40	30 x 10	Yes	118200	Yes	5.8
133606	Heelguard™ mesh galvanised steel 133606DL	500	173	40	30 x 10	Yes	118200	Yes	2.8

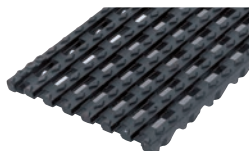

13073DL  
Intercept ductile iron\*\*

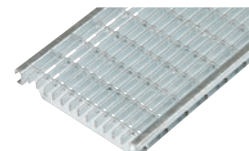

133605DL / 133606DL  
Heelguard™ mesh galvanised steel

24

## ACO ATec high performance finish

### Gratings for Load Class D 400\* applications with ACO ATec corrosion resistant coating



Product code	Description	Length (mm)	Width overall (mm)	Depth overall (mm)	Slot width /hole dia (mm)	Heelguard™	Intake area (mm²/m)	Anti shunt feature	Weight (kg)
23169	ATec coated Heelguard ductile iron 23169DL 	500	173	28	8	Yes	40000	Yes	6.8



23161DL  
Heelguard™ ductile iron



ACO ATec coating is a high performance finish that provides a superior resistance to corrosion. The electrochemically applied finish is strong and durable, making maintenance easier than on water-based surface coatings. The ATec finish also enhances long term durability in demanding environments and is particularly well suited for low trafficked areas. Please download our ATec datasheet for more information.

 Indicates security locking available.

\*Not suitable for carriageways of public roads or motorways.

\*\*Intercept ductile iron C250 grate is the original design, and differs aesthetically to the new D400 version





## Traditional gratings for Load Class D 400\* applications

Product code	Description	Length (mm)	Width overall (mm)	Depth overall (mm)	Slot width /hole dia (mm)	Heelguard™	Intake area (mm <sup>2</sup> /m)	Anti shunt feature	Weight (kg)
23161	Heelguard™ ductile iron 23161DL <b>6</b>	500	173	28	8	Yes	40000	Yes	6.8
23515	Heelguard™ Intercept ductile iron 23515DL	500	173	36	10	Yes	55500	Yes	6.4
23160	Solid cover ductile iron 23160DL	500	173	28	n/a	No	n/a	Yes	6.7
23164	Slotted ductile iron 23164DL	500	173	28	12	No	57664	Yes	6.4
133609	Heelguard™ mesh galvanised steel 133609DL <b>6</b>	1000	173	46	30 x 10	Yes	103400	Yes	8.0
133610	Heelguard™ mesh galvanised steel 133610DL <b>6</b>	500	173	46	30 x 10	Yes	103400	Yes	4.0
23175	Brickslot single slot offset galvanised steel 23175	1000	173	105	10	Yes	10000	No	7.7
23176	Brickslot single slot offset galvanised steel 23176	500	173	105	10	Yes	10000	No	3.9
23177	Brickslot single slot access unit galvanised steel 23177	500	173	105	10	Yes	10000	No	7.0
23520	Heelguard™ Intercept ductile iron 23520DL	500	223	43	10	Yes	76800	Yes	8.7



23161DL  
Heelguard™ ductile iron

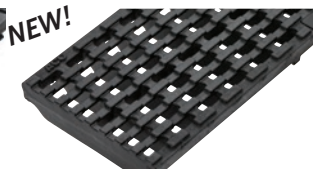

23515  
Intercept ductile iron



23160DL  
Solid cover ductile iron



23164DL  
Slotted ductile iron

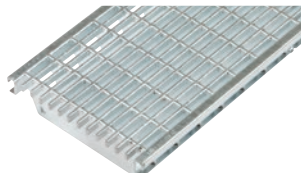

133609DL / 133610DL  
Heelguard™ mesh galvanised steel

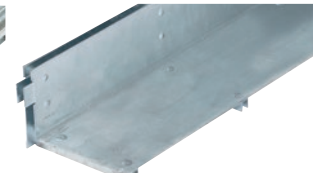

23175 / 23176  
Brickslot single slot galvanised steel

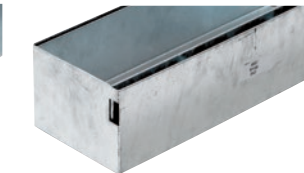

23177  
Brickslot single slot access unit galvanised steel



ACO can manufacture Brickslot grates in a wide range of sizes for specific site requirements. Twinslot grates (as seen in the M100D section) can also be manufactured for use with M150D channels. For more information please contact your sales representative.

## Grating accessories

Product code	Description	For use with	Length (mm)	Width overall (mm)	Depth overall (mm)	Weight (kg)
23165	Drainlock™ security locking assembly	23161, 23169	146	20	13	0.1
445831	Drainlock™ security locking assembly Mesh**	133601, 133602, 133605, 133606, 133609, 133610	146	27	13	0.1
445833	Drainlock™ security locking assembly Profile**	133625, 133626	146	27	13	0.1
23416	Drainlock™ security key	all	75	30	3	0.01
1367	Drainlock™ grating lifting tool	all	400	150	6	0.2

\*Not suitable for carriageways of public roads or motorways.

\*\*Security key 23416 not compatible, allen key required.

Note: 1m grates require 2pcs of Security locking assemblies and 0.5m grates require 1pc



# Gratings for use with ACO MultiDrain® M200D channels with galvanised edge rails



## Gratings for Load Class B 125 applications

Product code	Description	Length (mm)	Width overall (mm)	Depth overall (mm)	Slot width /hole dia (mm)	Heelguard™	Intake area (mm <sup>2</sup> /m)	Anti shunt feature	Weight (kg)
133613	Heelguard™ mesh galvanised steel 133613DL	6 1000	223	40	29 x 10	Yes	157500	Yes	7.2
133614	Heelguard™ mesh galvanised steel 133614DL	6 500	223	40	29 x 10	Yes	157500	Yes	3.6
133629	Intercept-Profile galvanised steel 133629DL	6 1000	223	39	29 x 8	Yes	84600	Yes	7.4
133630	Intercept-Profile galvanised steel 133630DL	6 500	223	39	29 x 8	Yes	84600	Yes	3.6

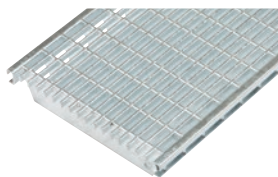

133613DL / 133614DL  
Heelguard™ mesh galvanised steel



133629DL / 133630DL  
Intercept-Profile galvanised steel



## Gratings for Load Class C 250 applications

Product code	Description	Length (mm)	Width overall (mm)	Depth overall (mm)	Slot width /hole dia (mm)	Heelguard™	Intake area (mm <sup>2</sup> /m)	Anti shunt feature	Weight (kg)
13473	Intercept ductile iron 13473DL**	500	223	35	30 x 14	No	90500	Yes	7.5
133617	Heelguard™ mesh galvanised steel 133617DL	6 1000	223	46	30 x 10	Yes	137700	Yes	10.7
133618	Heelguard™ mesh galvanised steel 133618DL	6 500	223	46	30 x 10	Yes	137700	Yes	5.2

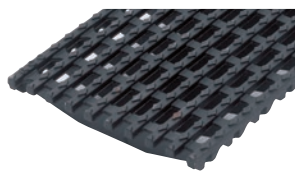

13473DL  
Intercept ductile iron\*\*

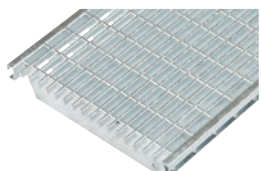

133617DL / 133618DL  
Heelguard™ mesh galvanised steel

## ACO ATec high performance finish



## Gratings for Load Class D 400\* applications with ACO ATec corrosion resistant coating

Product code	Description	Length (mm)	Width overall (mm)	Depth overall (mm)	Slot width /hole dia (mm)	Heelguard™	Intake area (mm <sup>2</sup> /m)	Anti shunt feature	Weight (kg)
23229	ATec coated Heelguard ductile iron 23229DL	6 500	223	32	8	Yes	47300	Yes	10.3



23229DL  
Heelguard™ ductile iron



ACO ATec coating is a high performance finish that provides a superior resistance to corrosion. The electrochemically applied finish is strong and durable, making maintenance easier than on water-based surface coatings. The ATec finish also enhances long term durability in demanding environments and is particularly well suited for low trafficked areas. Please download our ATec datasheet for more information.

6 Indicates security locking available.

\*Not suitable for carriageways of public roads or motorways.

\*\*Intercept ductile iron C250 grate is the original design, and differs aesthetically to the new D400 version.





## Gratings for Load Class D 400\* applications

Product code	Description	Length (mm)	Width overall (mm)	Depth overall (mm)	Slot width /hole dia (mm)	Heelguard™	Intake area (mm <sup>2</sup> /m)	Anti shunt feature	Weight (kg)
23221	Heelguard™ ductile iron 23221DL <b>6</b>	500	223	32	8	Yes	47300	Yes	7.5
23520	Heelguard™ Intercept ductile iron 23520DL	500	223	43	10	Yes	76800	Yes	8.7
23220	Ductile iron solid cover 23220DL	500	223	32	n/a	No	n/a	Yes	11.0
23224	Slotted ductile iron 23224DL	500	223	32	12	No	72400	Yes	9.8
133621	Heelguard™ mesh galvanised steel 133621DL <b>6</b>	1000	223	65	30 x 10	Yes	137700	Yes	12.9
133622	Heelguard™ mesh galvanised steel 133622DL <b>6</b>	500	223	65	30 x 10	Yes	137700	Yes	6.4
408995	Brickslot single slot offset galvanised steel 408995	1000	223	105	10	Yes	10000	No	9.8
408996	Brickslot single slot offset galvanised steel 408996	500	223	105	10	Yes	10000	No	4.8
408997	Brickslot single slot access unit galvanised steel 408997	500	223	105	10	Yes	10000	No	8.5



23221DL  
Heelguard™ ductile iron



23520  
Intercept ductile iron



23220DL  
Solid cover ductile iron



23224DL  
Slotted ductile iron



133621DL / 133622DL  
Heelguard™ mesh galvanised steel

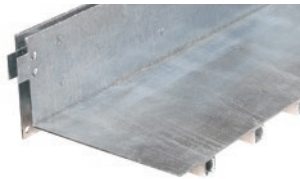

408995/408996  
Brickslot single slot galvanised steel



408997  
Brickslot single slot access unit galvanised steel



ACO can manufacture Brickslot grates in a wide range of sizes for specific site requirements. Twinslot grates (as seen in the M100D section) can also be manufactured for use with M200D channels. For more information please contact your sales representative.

## Grating accessories

Product code	Description	For use with	Length (mm)	Width overall (mm)	Depth overall (mm)	Weight (kg)
23225	Drainlock™ security locking assembly	23221, 23229	195	20	13	0.1
445834	Drainlock™ security locking assembly Mesh**	133613, 133614, 133617, 133618, 133621, 133622	195	27	13	0.13
445836	Drainlock™ security locking assembly Profile**	133629, 133630	195	27	13	0.11
23416	Drainlock™ security key	all	75	30	3	0.01
1367	Drainlock™ grating lifting tool	all	400	150	6	0.2

**6** Indicates security locking available.

\*Not suitable for carriageways of public roads or motorways.

\*\*Security key 23416 not compatible, allen key required.

Note: 1m grates require 2pcs of Security locking assemblies and 0.5m grates require 1pc.



# ACO MultiDrain® M100DS channels with stainless steel edge rails

ACO MultiDrain® M100DS channels are manufactured from Vienite®, ACO's sustainable high strength material, which provides high chemical resistance. For improved aesthetics and performance, the channels listed below are provided with integral stainless steel (Grade 304) protective edge rails.

These channels are available in constant depth and shallow depth units.

For the ACO MultiDrain® M100DS range of gratings to suit these channels please refer to pages 32-37.

## M100DS constant depth channels with stainless steel edge rails

Product code	Description	Length (mm)	Width overall (mm)	Depth overall (mm)	Invert depth (mm)	Invert Type	Weight (kg)
24075	M100DS No. 075	1000	135	75	55	1	10.9
24076	M100DS No. 075V	1000	135	75†	55	1	10.6
24110	M100DS No. 0100	1000	135	100	80	1	12.7
24111	M100DS No. 0100V	1000	135	100†	80	1	12.4
24000	M100DS No. 0.0*	1000	135	150	130	1/3	14.9
24050	M100DS No. 0.1J*	500	135	150	130	1/3	8.6
24100	M100DS No.10.0*	1000	135	200	180	1/3	17.9
24101	M100DS No.10.1J*	500	135	200	180	1/3	10.2
24200	M100DS No.20.0*	1000	135	250	230	1/3	21.0
24201	M100DS No.20.1J*	500	135	250	230	1/3	11.8

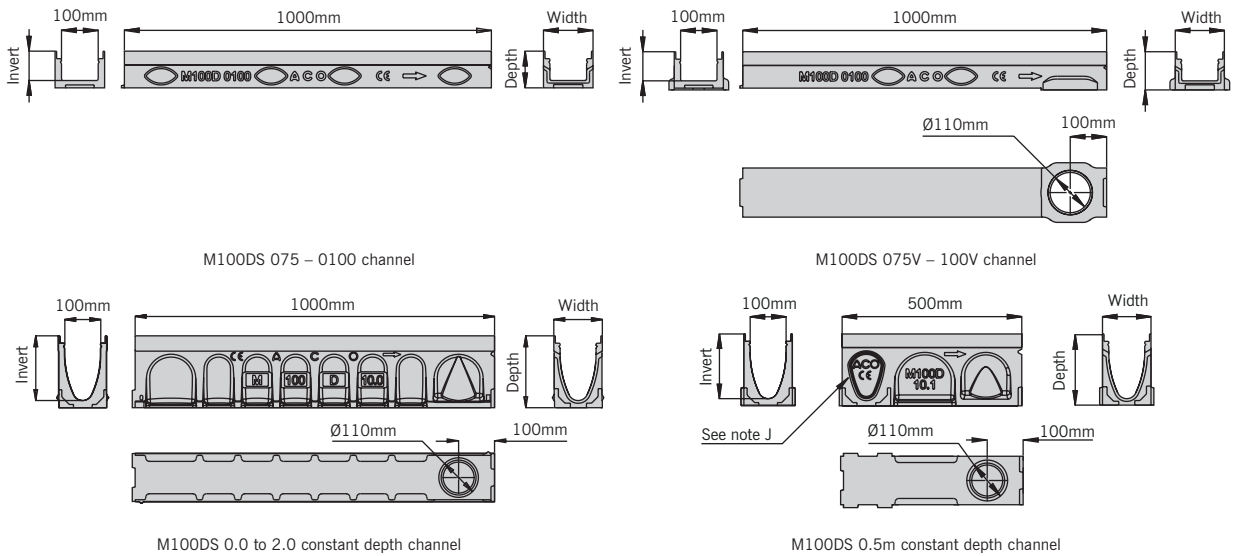

## M150DS constant depth channels with stainless steel edge rails

Product code	Description	Length (mm)	Width overall (mm)	Depth overall (mm)	Invert depth (mm)	Invert Type	Weight (kg)
24156	M150DS No. 0100	1000	185	100	75	1	16.7
24157	M150DS No. 0100V	1000	185	100	75	1	15.9
24150	M150DS No. 0.0*	1000	185	210	185	1/3	25.4
24153	M150DS No. 0.1J*	500	185	210	185	1/3	13.7
24151	M150DS No.10.0*	1000	185	260	235	1/3	28.0
24154	M150DS No. 10.1J*	500	185	260	235	1/3	15.6
24152	M150DS No.20.0*	1000	185	310	285	1/3	32.1
24155	M150DS No. 20.1J*	500	185	310	285	1/3	17.4

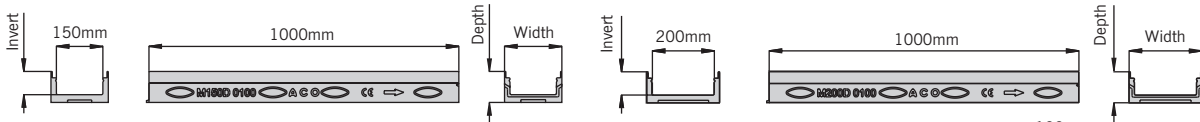

M150DS 0100 channel.

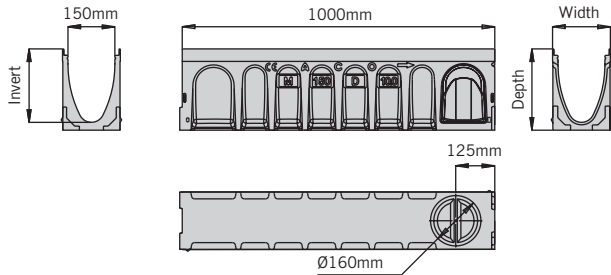

M150DS 0.0 to 2.0 constant depth channel

M150DS 0100V channel

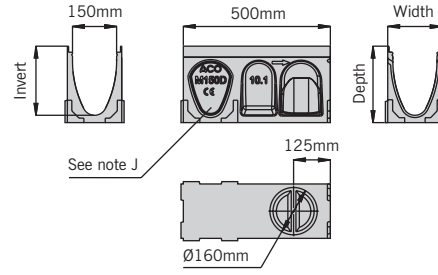

M150DS 0.5m constant depth channel

## M200DS constant depth channels with stainless steel edge rails

Product code	Description	Length (mm)	Width overall (mm)	Depth overall (mm)	Invert depth (mm)	Invert Type	Weight (kg)
24216	M200DS No. 0100	1000	235	100	75	1	19.4
24217	M200DS No. 0100V	1000	235	100	75	1	18.7
24210	M200DS No. 0.0*	1000	235	265	240	1/3	34.8
24213	M200DS No. 0.1J*	500	235	265	240	1/3	18.9
24211	M200DS No.10.0*	1000	235	315	290	1/3	39.2
24214	M200DS No. 10.1J*	500	235	315	290	1/3	20.9
24212	M200DS No.20.0*	1000	235	365	340	1/3	42.2
24215	M200DS No. 20.1J*	500	235	365	340	1/3	22.9

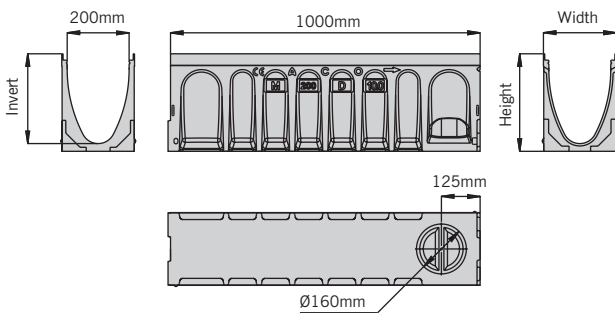

M200DS 0.0 to 2.0 constant depth channel

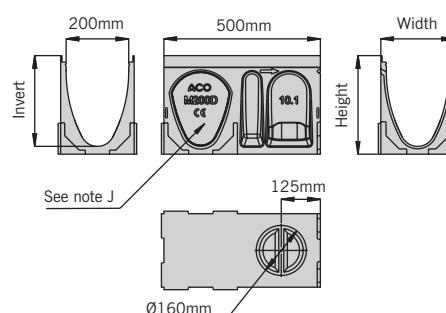

M200DS 0.5m constant depth channel

Note: The constant depth channels have an improved knockout feature, see page 41 for more information.

\* Indicates channels supplied with a preformed Ø160mm knockout for vertical outlet.

J Indicates side knockout for 90° channel connection. Knockout on both sides of the channel.

V Indicates channel with cast in TPE triple lipped seals for water tight connection. See page 41 for further information.

These products are subject to weight and dimensional tolerances. The dimensions shown on this page are for guidance purposes only.

### Multifunctional endcap (closing/inlet/outlet)

Product code	Description	Length (mm)	Width overall (mm)	Depth overall (mm)	Invert depth (mm)	Invert Type	Weight (kg)
23404	M100D multifunctional endcap	-	135	75/300	50	-	0.2
23159	M150D multifunctional endcap	-	185	310/100	75	-	0.3
23219	M200D multifunctional endcap	-	235	365/100	75	-	0.4

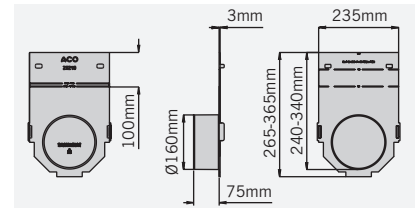
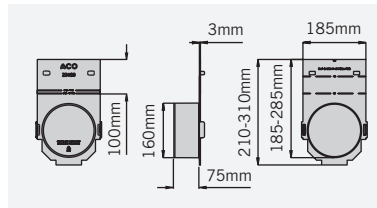
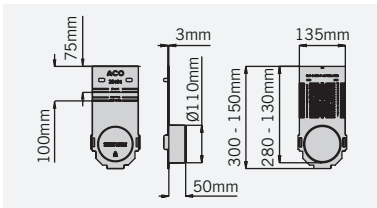

The multifunctional endcap can be cut down to suit all channels. See page 42 for further information.

### Step Connector

Product code	Description	Length (mm)	Width overall (mm)	Depth overall (mm)	Invert depth (mm)	Invert Type	Weight (kg)
12601	M100D 50mm step connector	100	75	50	-	-	0.4
13001	M150D 50mm Step connector	100	98	50	-	-	0.5
13401	M200D 50mm Step connector	100	120	50	-	-	0.6

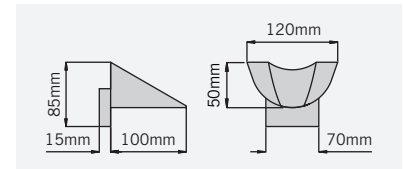
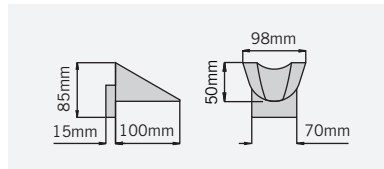
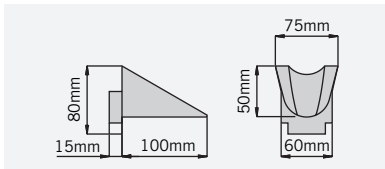

Note: For information on the step connector functionality see page 42.



### M100DS sump unit with stainless steel edge rails

Product code	Description	Length (mm)	Width overall (mm)	Depth overall (mm)	Invert depth (mm)	Invert Type	Weight (kg)
24410	M100DS universal sump with plastic silt bucket	500	135	635	615	-	33.9

Standard sump outlets

- 1 = Ø110mm outlet with triple lipped seal
- 2 = Ø110mm knockout
- 3 = Ø160mm knockout

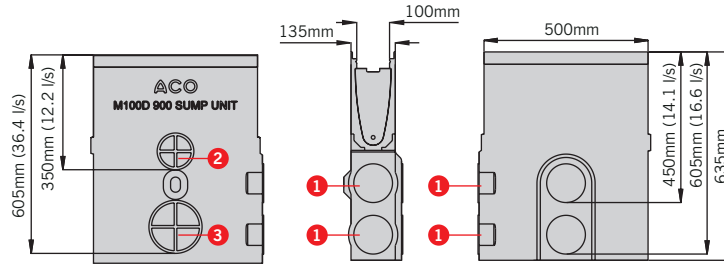

Note: Drawing shows flow through un-trapped unions. For information on the sump unit functionality see page 43.

### M150DS sump unit with UltraSTEEL™ galvanised edge rails

Product code	Description	Length (mm)	Width overall (mm)	Depth overall (mm)	Invert depth (mm)	Invert Type	Weight (kg)
24158	M150DS universal sump with plastic silt bucket	500	185	735	715	-	44.5

Standard sump outlets

- 1 = Ø110mm outlet with triple lipped seal
- 2 = Ø160mm outlet
- 3 = Ø200mm knockout

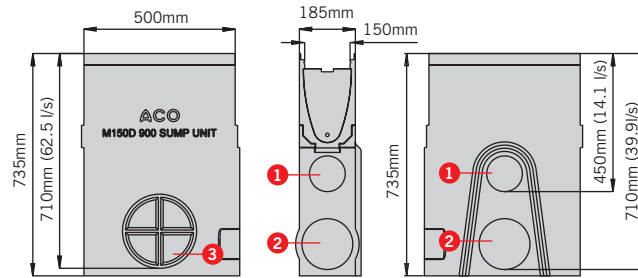

Note: Drawing shows flow through un-trapped unions. For information on the sump unit functionality see page 47.

### M200DS sump unit with stainless steel edge rails

Product code	Description	Length (mm)	Width overall (mm)	Depth overall (mm)	Invert depth (mm)	Invert Type	Weight (kg)
24218	M200DS universal sump with plastic silt bucket	500	235	790	765	-	48.0

Standard sump outlets

- 1 = Ø110mm outlet with triple lipped seal
- 2 = Ø160mm outlet
- 3 = Ø200mm knockout

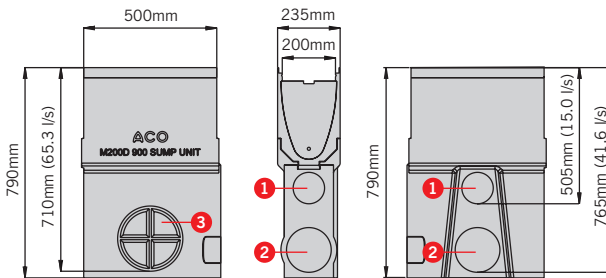

Note: Drawing shows flow through un-trapped unions. For information on the sump unit functionality see page 47.

Note: For ACO Universal Gully details please refer to page 15. For Foul air trap details please refer to page 17. For repair kit information please see page 17.

These products are subject to weight and dimensional tolerances. The dimensions shown on this page are for guidance purposes only.



# Gratings for use with ACO MultiDrain® M100DS channels with stainless steel edge rails



## Gratings for Load Class A 15 applications

Product code	Description	Length (mm)	Width overall (mm)	Depth overall (mm)	Slot width /hole dia (mm)	Heelguard™	Intake area (mm²/m)	Anti shunt feature	Weight (kg)
12640	Slotted stainless steel 460DL	1000	123	21	10	Yes	25300	n/a	2.0
12641	Slotted stainless steel 461DL	500	123	21	10	Yes	25300	n/a	1.0
12664	Perforated stainless steel 12664DL	1000	123	21	6	Yes	16300	n/a	2.6
12665	Perforated stainless steel 12665DL	500	123	21	6	Yes	16300	n/a	1.3



400DL / 402DL  
Slotted galvanised steel



400DL / 402DL  
Slotted galvanised steel



## Gratings for Load Class B 125 applications

Product code	Description	Length (mm)	Width overall (mm)	Depth overall (mm)	Slot width /hole dia (mm)	Heelguard™	Intake area (mm²/m)	Anti shunt feature	Weight (kg)
132557	Intercept Bar stainless steel 132557DL	1000	123	21	28 x 6	Yes	43000	Yes	3.8
132552	Intercept Bar stainless steel 132552DL	500	123	21	28 x 6	Yes	43000	Yes	1.9
132556	Intercept Profile stainless steel 132556DL	1000	123	21	29 x 8	Yes	44500	Yes	3.7
132551	Intercept Profile stainless steel 132551DL	500	123	21	29 x 8	Yes	44500	Yes	1.9



132557DL / 132552DL  
Intercept Bar Stainless Steel



132556DL / 132551DL  
Intercept Profile Stainless Steel



## Gratings for Load Class C 250 applications

Product code	Description	Length (mm)	Width overall (mm)	Depth overall (mm)	Slot width /hole dia (mm)	Heelguard™	Intake area (mm²/m)	Anti shunt feature	Weight (kg)
12644	Slotted stainless steel 470DL	1000	123	21	10	Yes	25300	n/a	5.0
12645	Slotted stainless steel 471DL	500	123	21	10	Yes	25300	n/a	2.5
12654	Perforated stainless steel 12654DL	1000	123	21	6	Yes	16300	n/a	4.8
12655	Perforated stainless steel 12655DL	500	123	21	6	Yes	16300	n/a	2.4
132882	Heelguard™ mesh stainless steel grating 430DL	1000	123	21	29 x 9.5	Yes	79000	Yes	4.2
132883	Heelguard™ mesh stainless steel grating 431DL	500	123	21	29 x 9.5	Yes	79000	Yes	2.1



470DL / 471DL  
Slotted stainless steel

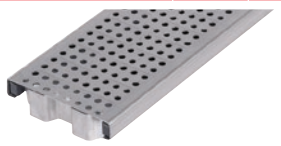

12654DL / 12655DL  
Perforated stainless steel



430DL / 431DL  
Heelguard™ mesh stainless steel

ACO MultiDrain® MD stainless steel gratings are manufactured from Grade 304 stainless steel and are fitted with ACO Drainlock™ as standard. See page 48 for installation details. For Drainlock™ grating lifting tool details please refer to page 33. \*Not suitable for carriageways of public roads or motorways.

*These products are subject to weight and dimensional tolerances. The dimensions shown on this page are for guidance purposes only.*







## Gratings for Load Class D400\* applications

Product code	Description	Length (mm)	Width overall (mm)	Depth overall (mm)	Slot width /hole dia (mm)	Heelguard™	Intake area (mm²/m)	Anti shunt feature	Weight (kg)
132887	Heelguard™ mesh stainless steel 132887DL	6 1000	123	21	28 x 8.5	Yes	69100	Yes	5.2
132888	Heelguard™ mesh stainless steel 132888DL	6 500	123	21	28 x 8.5	Yes	69100	Yes	2.5
23475	Brickslot single slot stainless steel 23475	1000	123	105	10	Yes	10000	No	6.6
23476	Brickslot single slot stainless steel 23476	500	123	105	10	Yes	10000	No	3.5
23477	Brickslot single slot access unit stainless steel 23477	500	123	105	10	Yes	10000	No	6.2
23480	Brickslot Twinslot offset stainless steel	1000	123	105	10 (x2)	Yes	20000	Yes	13
23481	Brickslot Twinslot offset stainless steel	500	123	105	10 (x2)	Yes	20000	Yes	6.5
23482	Brickslot Twinslot offset access unit stainless steel	500	123	105	10 (x2)	Yes	20000	Yes	11.3
23483	Brickslot Twinslot central stainless steel	1000	123	105	10 (x2)	Yes	20000	Yes	11.7
23484	Brickslot Twinslot central stainless steel	500	123	105	10 (x2)	Yes	20000	Yes	5.8
23485	Brickslot Twinslot central access unit stainless steel	500	123	105	10 (x2)	Yes	20000	Yes	14.2

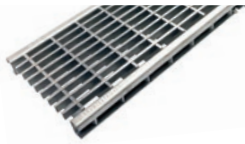

470DL / 471DL  
Slotted stainless steel

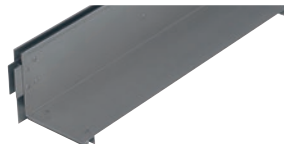

23475 / 23476  
Brickslot single slot stainless steel



23480/23481  
Brickslot Twinslot offset stainless steel



23483/23484  
Brickslot Twinslot central stainless steel

## Grating accessories

Product code	Description	For use with	Length (mm)	Width overall (mm)	Depth overall (mm)	Weight (kg)
445828	Drainlock™ security locking assembly Mesh B125 & C250	132882, 132883	96	20	13	0.07
445745	Drainlock™ security locking assembly Mesh** D400	132887, 132888	96	27	13	0.06
445830	Drainlock™ security locking assembly Profile**	132551, 132556	96	27	13	0.06
445829	Drainlock™ security locking assembly Bar**	132552, 132557	96	27	13	0.07
1367	Drainlock™ grating lifting tool	all	400	150	6	0.2



23415  
Drainlock™ security locking assembly

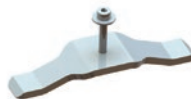

445831  
Drainlock™ security locking assembly Mesh\*\*



445833  
Drainlock™ security locking assembly Profile\*\*



445832  
Drainlock™ security locking assembly Bar\*\*



1367  
Drainlock™ grating lifting tool 835

6 Indicates security locking available.

\*Not suitable for carriageways of public roads or motorways.

\*\*Standard allen key required.

Note: 1m grates require 2pcs of Security locking assemblies and 0.5m grates require 1pc.



# Gratings for use with ACO MultiDrain® M150DS channels with stainless steel edge rails



## Grating for Load Class B 125 applications

Product code	Description	Length (mm)	Width overall (mm)	Depth overall (mm)	Slot width /hole Ø (mm)	Heelguard™	Intake area (mm²/m)	Anti shunt feature	Weight (kg)
133603	Heelguard™ mesh stainless steel 133603DL	1000	173	36	29 x 10	Yes	118200	Yes	5.5
133604	Heelguard™ mesh stainless steel 133604DL	500	173	36	29 x 10	Yes	118200	Yes	2.7
133627	Intercept-Profile stainless steel 133627DL	1000	173	30	29 x 9	Yes	68700	Yes	5.1
133628	Intercept-Profile stainless steel 133628DL	500	173	30	29 x 9	Yes	68700	Yes	2.6
133633	Intercept-Bar stainless steel 133633DL	1000	173	27	29 x 6	Yes	66800	Yes	5.5
133634	Intercept-Bar stainless steel 133634DL	500	173	27	29 x 6	Yes	66800	Yes	2.8

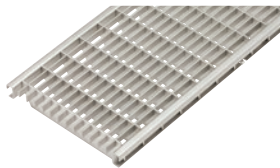

133603DL / 133604DL  
Heelguard™ mesh stainless steel



133627DL / 133628DL  
Intercept-Profile stainless steel



133633DL / 133634DL  
Intercept-Bar stainless steel



## Grating for Load Class C 250 applications

Product code	Description	Length (mm)	Width overall (mm)	Depth overall (mm)	Slot width /hole Ø (mm)	Heelguard™	Intake area (mm²/m)	Anti shunt feature	Weight (kg)
133607	Heelguard™ mesh stainless steel 133607DL	1000	173	40	30 x 10	Yes	118200	Yes	5.7
133608	Heelguard™ mesh stainless steel 133608DL	500	173	40	30 x 10	Yes	118200	Yes	2.9

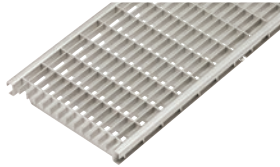

133607DL / 133608DL  
Heelguard™ mesh stainless steel





## Grating for Load Class D 400\* applications

Product code	Description	Length (mm)	Width overall (mm)	Depth overall (mm)	Slot width /hole Ø (mm)	Heelguard™	Intake area (mm²/m)	Anti shunt feature	Weight (kg)
133611	Heelguard™ mesh stainless steel 133611DL	Ⓜ 1000	173	46	30 x 10	Yes	103400	Yes	8.0
133612	Heelguard™ mesh stainless steel 133612DL	Ⓜ 500	173	46	30 x 10	Yes	103400	Yes	4.0
23185	Brickslot single slot stainless steel 23185	1000	173	105	10	Yes	10000	No	8.0
23186	Brickslot single slot stainless steel 23186	500	173	105	10	Yes	10000	No	4.1
23187	Brickslot single slot access unit stainless steel 23187	500	173	105	10	Yes	10000	No	7.2

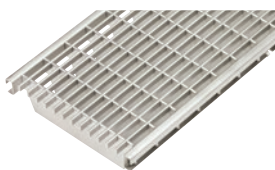

133611DL / 133612DL  
Heelguard™ mesh stainless steel

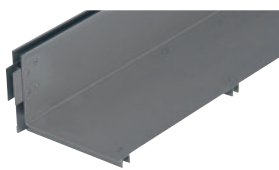

23185 / 23186  
Brickslot single slot stainless steel

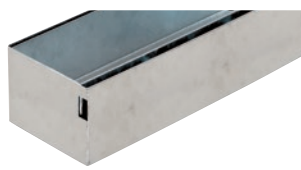

23187  
Brickslot single slot access unit stainless steel



ACO can manufacture Brickslot grates in a wide range of sizes for specific site requirements. Twinslot grates (as seen in the M100DS section) can also be manufactured for use with M150DS channels. For more information please contact your sales representative.

## Grating accessories

Product code	Description	For use with	Length (mm)	Width overall (mm)	Depth overall (mm)	Weight (kg)
445831	Drainlock™ security locking assembly Mesh**	133603, 133604, 133607, 133608, 133611, 133612	146	20	13	0.1
445833	Drainlock™ security locking assembly Profile**	133627, 133628	146	27	13	0.1
445832	Drainlock™ security locking assembly Bar**	133633, 133634	146	27	13	0.1
1367	Drainlock™ grating lifting tool	all	400	150	6	0.2



445834  
Drainlock™ security locking assembly Mesh\*\*



445836  
Drainlock™ security locking assembly Profile\*\*



445835  
Drainlock™ security locking assembly Bar\*\*



1367  
Drainlock™ grating lifting tool 835

Ⓜ Indicates security locking available.

\*Not suitable for carriageways of public roads or motorways.

\*\*Standard allen key required.

Note: 1m grates require 2pcs of Security locking assemblies and 0.5m grates require 1pc.

These products are subject to weight and dimensional tolerances. The dimensions shown on this page are for guidance purposes only.



# Gratings for use with ACO MultiDrain® M200DS channels with stainless steel edge rails



## Grating for Load Class B 125 applications

Product code	Description	Length (mm)	Width overall (mm)	Depth overall (mm)	Slot width /hole Ø (mm)	Heelguard™	Intake area (mm²/m)	Anti shunt feature	Weight (kg)
133615	Heelguard™ mesh stainless steel 133615DL	1000	223	40	29 x 10	Yes	157500	Yes	7.3
133616	Heelguard™ mesh stainless steel 133616DL	500	223	40	29 x 10	Yes	157500	Yes	3.7
133631	Intercept-Profile stainless steel 133631DL	1000	223	39	29 x 8	Yes	84600	Yes	7.4
133632	Intercept-Profile stainless steel 133632DL	500	223	39	29 x 8	Yes	84600	Yes	3.6
133635	Intercept-Bar stainless steel 133635DL	1000	223	35	29 x 6	Yes	86600	Yes	8.0
133636	Intercept-Bar stainless steel 133636DL	500	223	35	29 x 6	Yes	86600	Yes	4.0

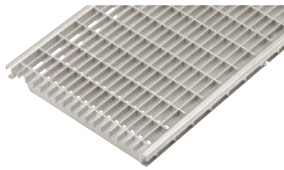

133615DL / 133616DL  
Heelguard™ mesh stainless steel



133631DL / 133632DL  
Intercept-Profile stainless steel



133635DL / 133636DL  
Intercept-Bar stainless steel



## Grating for Load Class C 250 applications

Product code	Description	Length (mm)	Width overall (mm)	Depth overall (mm)	Slot width /hole Ø (mm)	Heelguard™	Intake area (mm²/m)	Anti shunt feature	Weight (kg)
133619	Heelguard™ mesh stainless steel 133619DL	1000	223	46	30 x 10	Yes	137700	Yes	10.7
133620	Heelguard™ mesh stainless steel 133620DL	500	223	46	30 x 10	Yes	137700	Yes	5.3

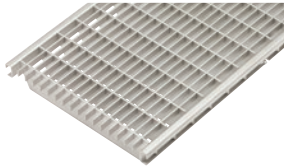

133619DL / 133620DL  
Heelguard™ mesh stainless steel





## Grating for Load Class D 400\* applications

Product code	Description	Length (mm)	Width overall (mm)	Depth overall (mm)	Slot width /hole Ø (mm)	Heelguard™	Intake area (mm²/m)	Anti shunt feature	Weight (kg)
133623	Heelguard™ mesh stainless steel 133623DL	1000	223	65	30 x 10	Yes	137700	Yes	13.0
133624	Heelguard™ mesh stainless steel 133624DL	500	223	65	30 x 10	Yes	137700	Yes	6.5
408998	Brickslot single slot stainless steel	1000	223	105	10	Yes	10000	No	9.8
408999	Brickslot single slot stainless steel	500	223	105	10	Yes	10000	No	4.8
409000	Brickslot single slot access unit stainless steel 409000	500	223	105	10	Yes	10000	No	8.5

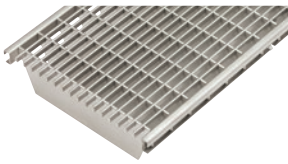

133623DL / 133624DL  
Heelguard™ mesh stainless steel

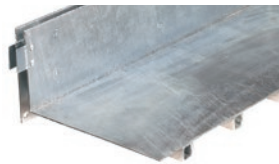

408998/408999 Brickslot  
single slot stainless steel



409000  
Brickslot single slot access unit stainless steel



ACO can manufacture Brickslot grates in a wide range of sizes for specific site requirements. Twinslot grates (as seen in the M100DS section) can also be manufactured for use with M200DS channels. For more information please contact your sales representative.

## Grating accessories

Product code	Description	For use with	Length (mm)	Width overall (mm)	Depth overall (mm)	Weight (kg)
445834	Drainlock™ security locking assembly Mesh**	133615, 133616, 133619, 133620, 133623, 133624	195	20	13	0.1
445836	Drainlock™ security locking assembly Profile**	133631, 133632	195	27	13	0.13
445835	Drainlock™ security locking assembly Bar**	133635, 133636	195	27	13	0.11
1367	Drainlock™ grating lifting tool	all	400	150	6	0.2



445834  
Drainlock™ security locking assembly Mesh\*\*



445836  
Drainlock™ security locking assembly Profile\*\*



445835  
Drainlock™ security locking assembly Bar\*\*



1367  
Drainlock™ grating lifting tool 835

**6** Indicates security locking available.

\*Not suitable for carriageways of public roads or motorways.

\*\*Standard allen key required.

Note: 1m grates require 2pcs of Security locking assemblies and 0.5m grates require 1pc.

These products are subject to weight and dimensional tolerances. The dimensions shown on this page are for guidance purposes only.



## Channel footpath drainage



CHANNEL FOOTPATH  
DRAINAGE

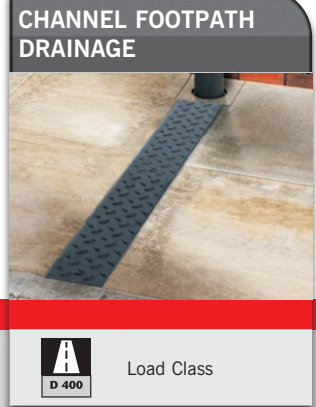

Channel footpath drainage is specifically used where roof drainage from down pipes is required to cross the footpath into the road gutter. Combining an ACO Downpipe connector and ACO Kerb outlet with ACO MultiDrain® M100D/M100DS channel creates a safer method for water to cross pedestrian areas.

The system can be installed with either a grated channel or solid cover and is suitable for Load Class D 400 applications. The high load class is required as vehicles may occasionally mount the kerb, and ACO's channel footpath drainage has been designed to withstand these loads.

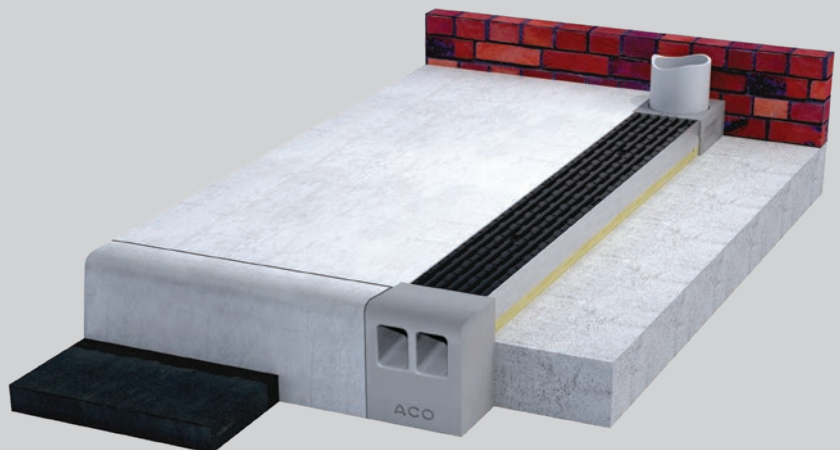

# Channel footpath drainage

The ACO MultiDrain® M100D/M100DS system includes a range of accessories which provide a drainage solution ideal for areas where down pipes from roofs and gutters exit on to the pavement. The ACO Channel Footpath drainage system effectively carries water away from paved areas and across into the adjacent carriageway.

The system uses ACO MultiDrain® M100D/M100DS shallow depth channels and has two types of kerb outlets and down pipe connectors to suit application requirements.

## Shallow channels

ACO MultiDrain® MD shallow depth channels are available in two sizes, 75mm and 100mm total depths (ACO M100D / M100DS 075 and ACO M100D / M100DS 0100) and have the option of galvanised or stainless steel edge rails.

## Downpipe connectors

Two down pipe connectors are available to suit channel depth. Manufactured from grey polymer concrete the down pipe connector has a clear opening of Ø75mm and connects to down pipes with outside diameters of up to 82mm.

## Kerb outlets

Two outlets are available to suit the kerb profile of the application, a CFD half battered kerb outlet to suit standard HB kerbs and a CFD Bull nose kerb outlet to match BN kerbs. Manufactured from grey polymer concrete the kerb outlets allow rainwater to discharge into the road gutter from this system.

## Gratings

Traditionally solid ductile iron covers are selected in channel footpath drainage applications but all ACO MultiDrain® M100D/M100DS gratings are suitable for use with this system. The system's load class rating is determined by the grating selected, further information of gratings within the range can be found on pages 21–27 and 32–37.

### ACO MultiDrain® M100D shallow depth channels with UltraSTEEL™ galvanised edge rails

Product code	Description	Length (mm)	Width overall (mm)	Depth overall (mm)	Invert depth (mm)	Invert Type	Weight (kg)
23075	M100D No. 075	1000	135	75	55	1	9.2
23076	M100D No. 075V	1000	135	75*	55	1	8.9
23110	M100D No. 0100	1000	135	100	80	1	11.0
23111	M100D No. 0100V	1000	135	100*	80	1	10.7

### ACO MultiDrain® M100DS shallow depth channels with stainless steel edge rails

Product code	Description	Length (mm)	Width overall (mm)	Depth overall (mm)	Invert depth (mm)	Invert Type	Weight (kg)
24075	M100DS No. 075	1000	135	75	55	1	10.9
24076	M100DS No. 075V	1000	135	75*	55	1	10.6
24110	M100DS No. 0100	1000	135	100	80	1	12.7
24111	M100DS No. 0100V	1000	135	100*	80	1	12.4

### Down pipe connectors

Product code	Description	Length (mm)	Width overall (mm)	Depth overall (mm)	Invert depth (mm)	Invert Type	Weight (kg)
23450	CFD075 downpipe connector grey	150	135	75	n/a	n/a	2.4
23451	CFD0100 downpipe connector grey	150	135	100	n/a	n/a	3.0

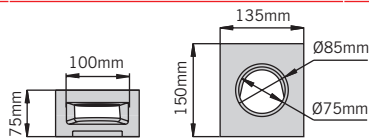

CFD 075 downpipe connector

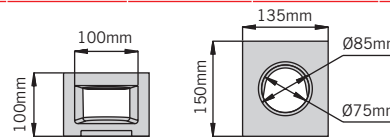

CFD 0100 downpipe connector

### Kerb outlet profiles

Product code	Description	Length (mm)	Width overall (mm)	Depth overall (mm)	Invert depth (mm)	Invert Type	Weight (kg)
23452	CFD kerb outlet half batter grey	125	135	225	n/a	n/a	6.7
23453	CFD kerb outlet bull nose grey	125	135	225	n/a	n/a	7.0

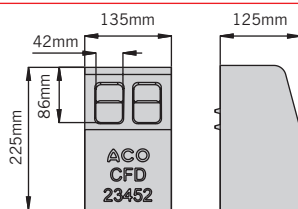

CFD kerb outlet half batter

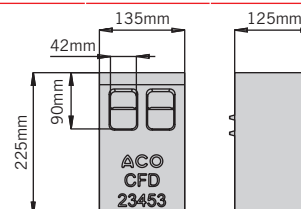

CFD bull-nose kerb outlet

Note: V Indicates channel with cast in triple lipped seals for water tight connection. See page 41 for further details.

\* 075V and 0100V channels have a depth overall around the outlet of 80mm (075V) and 105 (0100V).

These products are subject to weight and dimensional tolerances. The dimensions shown on this page are for guidance purposes only.

# ACO Downpipe connectors for use with the MultiDrain systems

The ACO rainwater downpipe channel connector is an effective method for connecting downpipes directly into the channel body, eliminating the risk of blockages and allowing full flow.

The connector is maintenance friendly and can be easily lifted from the channel to clear localised blockages without the need to lift the entire grating. The connector can be positioned in line or perpendicular to the channel depending on the installation location and has an overhang lip to hide the cut edge of the adjacent grating – resulting in a tidy and safe installation.

The connector is offered in a range of sizes and colours for circular or square downpipes. The connectors can be used on a variety of channels including MultiDrain, MultiDrain PPD and Multiline Sealin.

Details of the MultiDrain PPD and Multiline Sealin ranges can be found on the ACO website: [www.aco.co.uk](http://www.aco.co.uk)

- ▶ Direct connection into the channel eliminating blockages in the grating
- ▶ Quick and simple installation
- ▶ Easy maintenance
- ▶ Sizes, shapes and colours to suit most downpipes and installations

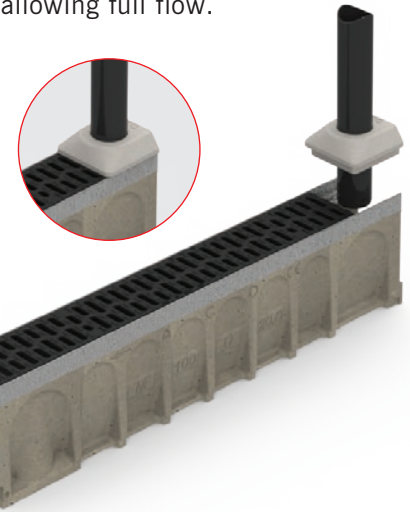

## Black Downpipe connectors

Product code	Description	Length (mm)	Width overall (mm)	Depth overall (mm)	Weight (kg)
27132	Downpipe connector, M100D/PPD Ø68mm*	142	133	60	1.07
27138	Downpipe connector, M100D/PPD □ 65mm*	142	133	60	1.04
27150	Downpipe connector, M150D/PPD Ø110mm	192	183	60	1.65
27152	Downpipe connector, M150D/PPD □ 100mm	192	183	60	1.66
27155	Downpipe connector, M200D/PPD Ø110mm	242	233	60	2.58

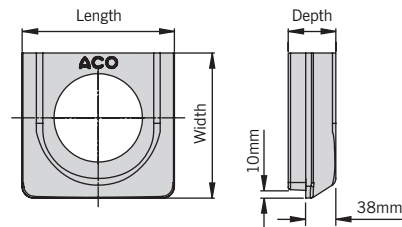
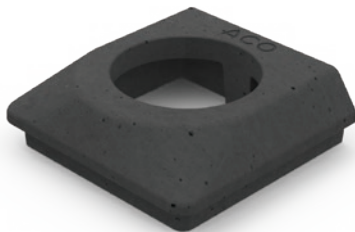

## Grey Downpipe connectors

Product code	Description	Length (mm)	Width overall (mm)	Depth overall (mm)	Weight (kg)
27133	Downpipe connector, M100D/PPD Ø68mm*	142	133	60	1.07
27139	Downpipe connector, M100D/PPD 65mm*	142	133	60	1.04
27151	Downpipe connector, M150D/PPD Ø110mm	192	183	60	1.65
27153	Downpipe connector, M150D/PPD 100mm	192	183	60	1.66
27154	Downpipe connector, M200D/PPD Ø110mm	242	233	60	2.58



\*Also compatible with ACO HexDrain Pro and ACO CivicDrain

*The products are subject to weight and dimensional tolerances. The dimensions shown on this page are for guidance purposes only.*





# Preparing the system for installation

## Channel base knockout details

All ACO MultiDrain® MD constant depth channels in the height range 0.0 to 30.0 are supplied with a pre formed knockout detail in the base of the channels. This knockout detail positioned at the male end of the channel allows a vertical connection to be made from the channel to a Ø110mm (100mm wide bore) or Ø160mm (150mm and 200mm wide bore) PVC-U pipe system. The knockout detail on the base of the channel is indicated by a “hammer” symbol. The method of removal and pipe connection is described below.

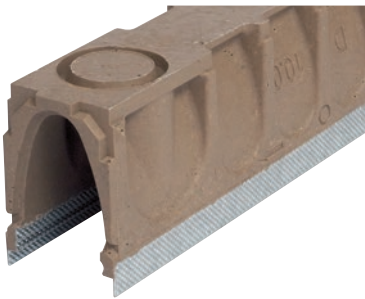

Knockout detail.

### FUNCTIONS:

**Step 1:** Pre formed knockout detail



**Step 2:** Support channel around knockout detail by placing the channel on sand or soft earth for example. Tap the knockout panel from the side indicated by the Hammer symbol to remove panel.



**Step 3:** Push fit pipe into recess provided and seal as required. For recommended sealants refer to the section headed “watertight sealing”.



## Channel side wall connection detail

An additional feature provided on all 500mm long channels are removable side wall panels, which allow channel runs to be connected together to form “T” or “L” junctions for continuous water flow through the system. Where channel connections are to be made to the side wall of these units a female joint detail is provided to aid alignment and fast installation.



Removable side wall panel.

### FUNCTIONS:

**Step 1:** Using a disc cutter as shown, cut a cross into the panel provided. Ensure cuts extend to but not beyond the perimeter recess surrounding the removable panel.



**Step 2:** Tap segments of panel between the cuts to remove the panel.



**Step 3:** Use a chisel to tidy up any remaining material. Channel connection can now be made and sealed as required.



## Shallow Channels

The ACO MultiDrain® MD shallow channels are available in either 75mm or 100mm overall depths. These units are ideal for use where installation depths are restricted such as in structural slabs, bridge decks and roofs. All units can be sealed for watertight installations as each unit is supplied with a preformed sealant groove (see section headed watertight sealing for further details).

The shallow channels identified with a “V” such as the O75V and O100V units have a cast-in triple lipped seal in their base for push fit watertight connections to Ø110mm PVC-U pipe. These triple lipped seals are manufactured from SEBS-TPE have excellent chemical, UV and weather resistance.



### FUNCTIONS:

**Step 1:** Ensure Triple lipped seal and pipe spigot are clean and free from debris



**Step 2:** Lubricate joint faces as required and push fit pipe into the seal. The pipe is fully fitted when the end of the pipe is flush with the internal base of the channel.



### Step connector

Each width of MultiDrain® MD has available a step connector manufactured from polymer concrete. This unit is used between constant depth channel joints where a stepped fall channel installation is required and takes up the 50mm height difference between units. The step connector ensures a smooth water flow within the channel system.



### Watertight sealing

ACO MultiDrain® MD channels are generally installed without a particular water seal. Once butt jointed and with a concrete surround a fairly watertight installation is achieved. If however a watertight system is required each MultiDrain® MD channel is provided with a sealant groove allowing the system to be sealed by the application of a flexible sealant either during or following installation. For rainwater applications we recommend a single component, polyurethane based elastomeric joint sealant such as BASF Masterflex 472 or Sika Sikaflex 11FC or similar.

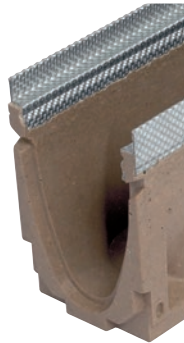

Application of sealant to be in accordance with the sealant manufacturers recommendations, but for guidance a typical method of application is as follows.

### Multifunctional endcap

A Multifunctional endcap is provided for each channel width that is designed to be used with all channel heights in each range. Manufactured from polypropylene these versatile endcaps can be adjusted on site to perform the function of a closing endcap or as an inlet/outlet endcap for connection to Ø110mm (100mm wide bore) or Ø160mm (150mm and 200mm wide bore) PVC-U pipe.

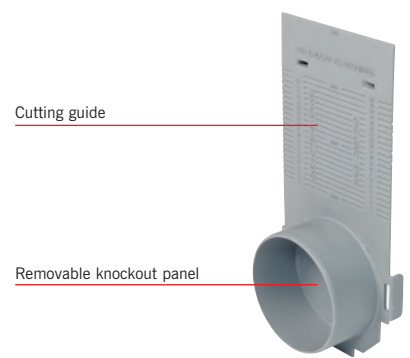

#### FUNCTIONS:

**Step 1:** Place step connector into the base of the deeper channel to be jointed as shown.

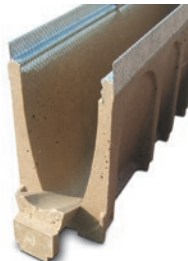

**Step 2:** Push channel joint together to lock step connector in place forming a smooth transition between units as shown.



#### FUNCTIONS:

**Step 1:** Jointing faces of the channels to be sound and cleaned to remove all loose material, dust, oil and grease. This can be done by the use of a wire brush.



**Step 2:** Butt joint the channels & install as per ACO installation instructions. Ensuring joints are still clean (surfaces can be damp but no water droplets should be evident) apply sealant with a cartridge gun approximately 5mm thick to the end face of the channel & completely fill the sealant groove. Note this type of channel can be sealed either at or following installation.



**Step 3:** Wipe excess sealant from the inside faces of the channel & inspect sealant groove to ensure it has been fully filled with sealant. Leave sealant to cure before use as per the sealant manufactures recommendations.



#### FUNCTIONS:

**Closing endcap:** The endcap supplied fits directly to the deepest channel within the system. All other channel heights can be accommodated by simply cutting the endcap to suit. A cutting guide is printed on the front of the endcap plate. The endcap is fastened to the channel by two clips and can be connected to either male or female channel end.



Adjusting endcap.

Fitting endcap to channel

**Inlet & Outlet endcap:** The endcap has a knockout panel which can be removed with a hammer. Once fitted to the channel the endcap performs either an inlet or outlet function and is designed to provide a connection to Ø110mm (100mm wide bore) or Ø160mm (150mm and 200mm wide bore) PVC-U pipes.



Adjusting endcap.

Fitting endcap to channel



## Sump unit

A polymer concrete chamber unit which provides the capacity to hold water and silt, and also provides an outlet for the channel system.

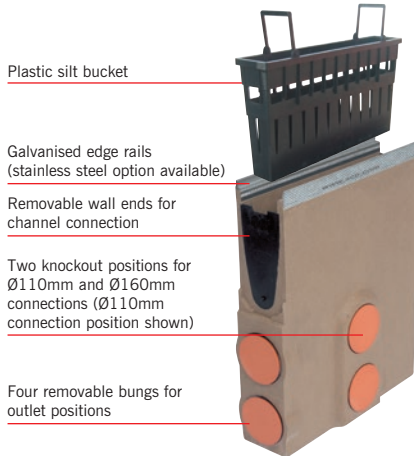

## Roddable foul air traps

A drain connector available in Ø110mm and Ø160mm for connection to foul or combined drainage. Foul air traps come complete with removable bung for rodding and are manufactured from highly durable recyclable MDPE.



## ACO Universal gully

A recycled plastic & ductile iron modular system purposely designed for use with ACO channel drainage systems up to 200mm internal width. The system provides a high capacity for retaining water and also an outlet for the drainage system.



### FUNCTIONS:

**Step 1:** Triple lipped seals for watertight connections.



**Step 2:** Unit wall ends can easily be removed using knife or saw.



**Step 3:** Two knockouts for Ø110mm and Ø160mm pipe connections. For knockout removal refer to method stated on page 45 headed 'Channel side wall connection detail'.



### FUNCTIONS:

**Step 1:** Push the foul air trap into place.



**Step 2:** Bung can be removed for rodding



### FUNCTIONS:

**Step 1:** Once installed ACO Universal Gully can be cut to match channel depth



**Step 2:** The cut ACO Universal Gully matches the profile of the ACO MultiDrain® MD channel.



**Note:** Full installation details are available to download from [www.aco.co.uk](http://www.aco.co.uk)



ACO's Polymer concrete repair kit is available for bonding applications, for instance where a mitred channel joint is to be made or for the repair of small areas of aesthetic damage. For further product details please see page 17.



# ACO Drainlock™ Gratings

## ACO Drainlock™

Fitted as standard to ACO MultiDrain® MD gratings, this fast locking device removes the need for bolts and bars and improves the channels hydraulic capacity. The Drainlock™ mechanism simply clips into the channel edge rail for rapid installation. An installation guide is shown opposite.



**FUNCTIONS:**



Push or stand on the grating until it clicks into place



To install, align the grating onto the channel  
Align anti-shunt detail with recess



ACO Drainlock™ locking mechanism fastens into the channel. Gratings should be fitted in the channels before the installation concrete is installed

## Anti-shunt mechanism

A selection of the ACO Drainlock™ gratings are fitted with an anti-shunt mechanism that restricts unwanted grating movement when installed.

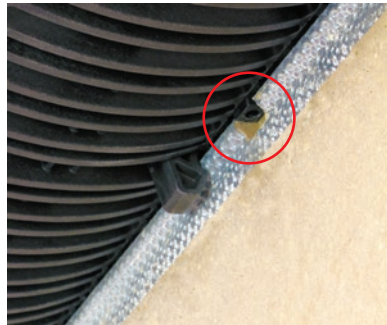

**FUNCTIONS:**



The anti-shunt lines the grate up to the channel and prevents the grates ability to move linearly. When cutting channels to required lengths, remember to also align the grate to the channel so the anti-shunt engages



If your inastallation requires the channel to be cut or mitred, ensure the grate still aligns with the anti-shunt. Photo shows a bad installation where the grate overlaps the channel junction

## Removal of grating

It is recommended that all ACO grates are lifted with our Drainlock™ lifting tool, which allows quick and easy lifting of the grate close to the Drainlock™ mechanism.



**FUNCTIONS:**

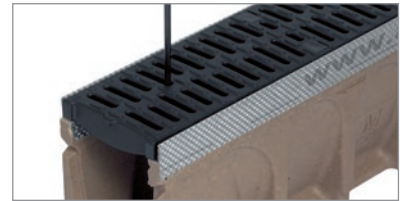

Insert tool as shown. Drainlock™ lifting tool available part no 1367

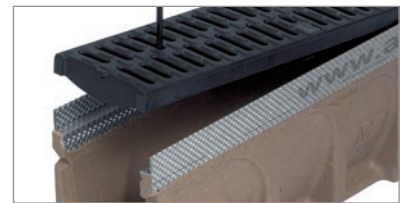

Pull upwards to unlock grating



## Security Locking

In areas such as schools and prisons, where unwanted grating removal needs to be restricted, a security locking can be used in conjunction with the following gratings; and options are available for most styles of galvanised and stainless steel grates. The system is fitted to the gratings by one or two M5/M6 screws and clamps the grating in place preventing removal. Security locking key for installation and removal supplied separately.

### FUNCTIONS:



For ductile iron grates, fix the security screws and clamp the grating as shown.



Place grating into the channel and tighten the fixing using the security locking key. Galvanised and stainless steel grate's security locking must be expanded rather than tightened to press against the Drainlock™ mechanism. Please refer to the Drainlock™ tables for more information.

## Grating selection

All channels within the ACO MultiDrain® MD range are certified to BS EN 1433: 2002 Load Class D 400. The system has a wide range of gratings suitable for use in a variety of applications from Load Class A15 to D 400\*. Refer to the chart on page 8 for load classes and typical applications. Please note when selecting a grating careful consideration should be given to the application requirement. Each grating has a certified load class which, once installed with the channel determines the system's load class.



## Surface + Grating Visualiser

A clever, yet easy to use software program that visualises how our range of grating designs could enhance your project.



To make specification easier, the software will suggest our most suitable ranges based on the project requirements.

You can then select from the available options and visualise how these may look in different surface finishes. Once a choice is made, a simple, yet detailed specification sheet provides full product information.



To launch the visualiser scan the QR code or visit [www.aco.co.uk/gratingvisualiser](http://www.aco.co.uk/gratingvisualiser)



Heelguard™ applies to ACO's range of 'Heel-friendly' products with slot widths up to and including 10mm. Suitable for most pedestrian applications and compliant to BS EN1433:2002. For specific widths please refer to grating details.

\*Not suitable for carriageways of public roads or motorways

## Design Software

# ACO QuAD Hydraulic Design Software

### TRY OUR FREE DESIGN TOOL

The new free-to-use ACO QuAD Hydraulic Design software has unprecedented levels of choice and flexibility built-in, to enable the efficient and accurate hydraulic design of any surface water management scheme.

The hydraulic engine has been robustly tested and is the tool used by ACOs own internal Design Services team in modelling surface water solutions for customers.

ACO QuAD Hydraulic Design software uses differential equations for spatially varied flow that online alternative solutions cannot accurately match. For example the Manning's equation for steady uniform flow does not work with level channels and is grossly inaccurate on shallow gradients.



Here are some of the features it includes:

- Powerful project-based software
- Create catchment models that are fully editable
- PDF summary document output
- Cloud based – All designs are stored securely on our server against your login
- Integrated rainfall data for the whole of the UK

To use the QuAD Hydraulic Design software visit: [www.aco.co.uk/quad-hydraulic-design-2.0](http://www.aco.co.uk/quad-hydraulic-design-2.0)

### QUAD FEATURES OVERVIEW

#### Cloud based

The software means increased efficiency providing design resources you need when you need it, allowing you to deploy the same design capability consistently, with the same consistency in results every time.



#### Flexible download format

Output can be generated for all or parts of the project and can be generated in pdf or CSV formats.



#### Secure scheme filing

All designs created by registered users are stored on a secure server and are password protected. Past projects are easily retrieved from the personalised menu.



#### Application

Application selection ensure designers are able to get quick and accurate guidance in selection of the most suitable products based on the type of application the catchment is to cater for.



#### Knowledge database

There is support available either through a query submission or through self-help made possible by the comprehensive Knowledge database.



#### Flexible catchment design

QuAD is designed to support designers in the creation of catchment areas. Supplementary catchment areas can easily be added upstream and downstream of any previously designed channel run.



#### Rainfall assist

Rainfall intensity by location matters in design. QuAD provides a site locator map enabling the most accurate intensity to be input.



#### Product optimiser

Optimising the specific channel runs can be done with the optimiser feature selecting the smallest product suitable. Excavation and concrete requirements are also provided.



#### Resilience assessment

By inputting anticipated sedimentation rates and sedimentation density the QuAD software enables the designer to test their suggested maintenance schedules.



#### Attenuation assessments

Calculate the attenuation required for the project and compare it with the storage available in the channel design. Attenuation volume is presented along with suitable options for storage.



**Register Now - It's Free**  
[www.aco.co.uk/quad-hydraulic-design-2.0](http://www.aco.co.uk/quad-hydraulic-design-2.0)



# Design Support Services

Surface water management system design can often be a complex task. Success in combining products and processes requires a thorough understanding of how these different elements work together.

The ACO Design Services Team is able to work closely with you through the entire design process to ensure accurate and cost-effective product selection is made.

Services we offer include (free and without obligation):

- Whole system design, from collection to the attenuation of surface water
- Hydraulic calculations and AutoCAD detailing
- Parts schedules

ACO has embraced the concept of value engineering as an approach to on-site construction that saves both time and money.

ACO will review any design to minimise the total scheme and life cost of a proposal. The team can suggest the most appropriate range depending on your requirements.

Some ranges like MultiDrain or MonoDrain allow water to be contained and conveyed close to the surface, which accords with the principles advocated for Sustainable Drainage (SuDS Manual, 2015), by removing the need for pumping. Other ranges like Qmax allow attenuation – the storage of large volumes of water during storm events, reducing overall site costs.

For detailed designs using the ACO Hydraulic Design Software, please contact the ACO Water Management Design Services Team.

If manual calculations are preferred to using our QUAD software, hydraulic tables and instructions for manual calculations can be provided.

## ACO Water Management Design Services Team

Tel: 01462 816666

Email: [technical@aco.co.uk](mailto:technical@aco.co.uk)

## ACO BIM MODELS

BIM is the process of generating and managing data, and developing collaborative behaviours that will unlock new and more efficient ways of working at all stages of the project life-cycle. These files will help contractors specify and optimise drainage systems in line with the overall benefits of BIM-enabled

working, including faster project delivery, reduced costs, reduced waste and greater project predictability.

Depending on the product range Civils3D, IFC or Revit files are available for download.

[www.aco.co.uk/aco-bim-models](http://www.aco.co.uk/aco-bim-models)

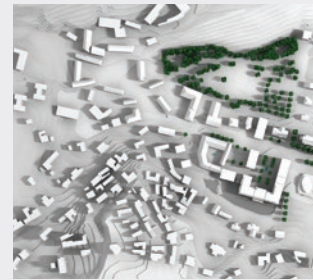

## Professional Development

### Helping create knowledge champions

In today's ever-changing construction industry, it has never been more important to ensure you are up to date with current industry trends and new innovations. Surface water management is one of the most dynamic sectors of the construction industry with new legislation, innovative products and ground-breaking materials constantly emerging.

Depending on your professional body or employer, you may be required to undertake between 20 and 30 hours CPD per year. ACO understands this can be a daunting task and has developed a series of professional

development courses that can be accessed in a number of ways including online, in-office or at our state-of-the-art training facility at ACO UK office headquarters in Bedfordshire.

The courses have been carefully developed to provide essential learning and knowledge and are delivered by ACO's UK wide experienced Business Development Team ensuring that only the highest quality content is delivered.



To find out more and book a professional development course, visit: [www.aco.co.uk/professional\\_development](http://www.aco.co.uk/professional_development)



# Installation detail

## CHANNELS WITH TRADITIONAL GRATINGS

### Asphalt pavement

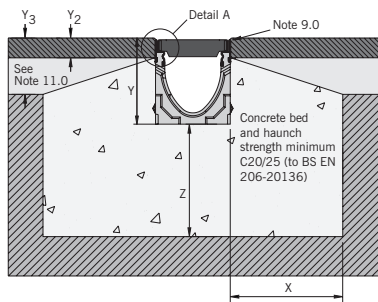

### Concrete pavement

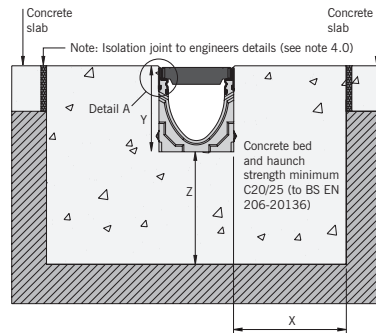

### Block pavement

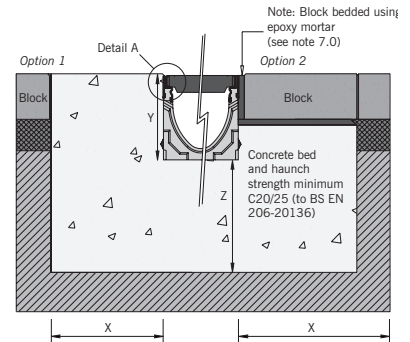

### 1.0 Load Class

Installation recommendations shown are ACO minimum recommendations for BS EN 1433:2002 load class requirements.

### 2.0 Ground Conditions

The long term performance of a channel installation to sustain vertical and lateral loads depends upon a) ground conditions, b) stability of the adjacent pavement and c) a durable concrete bed and surround. The recommended installation detail may require the minimum dimensions to be revised to achieve site specific load class requirements (referred to in 1.0 above).

### 3.0 Cutting and Jointing

Mitre joints are formed by cutting the channels to the required angle and butting them together with the appropriate sealant (e.g. Sikaflex 11FC or similar) or ACO Repair Kit. Where possible 90° joints and T's should be formed so that gratings do not have to be cut. Angles can be formed by connecting them using proprietary PVCu pipework attached to the ACO inlet/outlet endcaps. For further details please contact ACO Design Services Team. Note: For load classes higher than C 250, mitred joints are not recommended in vehicular areas. Where requested ACO can custom manufacture angled joints to order.

### 4.0 Isolation Joints

The channel must be isolated from the surrounding environment. An isolation joint must be positioned up to 1500mm from the channel wall. Any dowel bars must be located no nearer than 150mm from the channel wall. Other isolation joints in surrounding slab must be continued through the channel. Additional crack control may be required to comply with specifier requirements.

### 5.0 installation into in-situ slab

Where a channel is to be installed into an existing concrete slab it is necessary to cut a suitably sized pocket in the slab. The channel will then need to be bedded in polymer modified mortar of 25mm minimum thickness (this may vary depending on the type of mortar used). Engineering advice may be necessary.

### 6.0 Temporary installation

A channel installation is not complete until the final surfacing is laid. In any temporary condition, i.e., the channel walls projecting above adjacent ground, site traffic should not cross channels. Loose boards, stone fill or cover plates will not protect the channel walls or grating. A temporary channel crossing should be formed by raising the ground level locally, to 3-6mm above top of edge rail, either side of a channel for a distance of 750 to 1000mm, to form ramps. Note that the channel load class should be adequate to carry the site traffic.

### 7.0 Block pavements

The channel must be supported laterally. Blocks laid directly against the channel must be laid as a soldier course and restrained from movement by bedding securely on the concrete haunch e.g. by using a polymer modified mortar for bed and perpendicular joints (e.g.. RONAFIX mortar mix C or similar). Blocks or slabs bedded on sand remote from the channel should be set at a higher level to compensate for possible settlement of the paving in service.

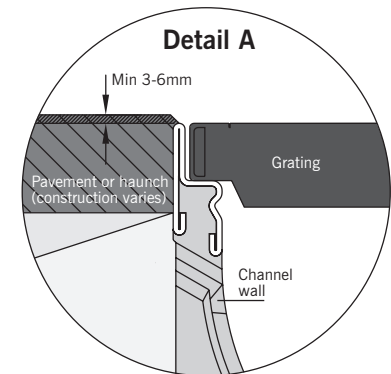

### 8.0 Grate locking system

Gratings should be securely fixed to the channel, where required, using an appropriate grate lock system (where available).

### 9.0 Channel protection

Avoid contact between compaction equipment and top of ACO channel edge rail. The installer must ensure that the finished surface level lies above the top of the edge rail (by at least 3-6mm). Covering or protecting the grating, before concreting the haunch or laying blocks, removes the time and cost associated with cleaning the channel and grating of cement material and embedded stones. (Please note that ACO channels must be installed with the grating in place to prevent deformation of the channel.)



# Installation detail

## CHANNELS WITH BRICKSLOT GRATINGS

### Block pavement

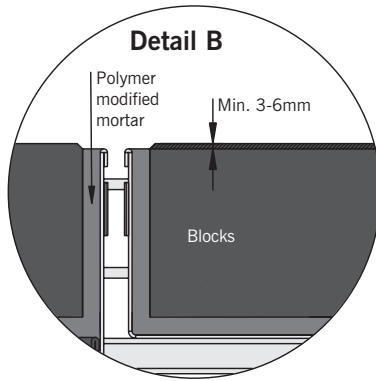
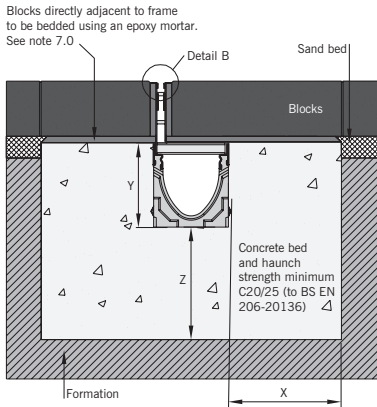

**i** An electronic version of the ACO MultiDrain® MD installation detail is available to download from the ACO website. Visit [www.aco.co.uk](http://www.aco.co.uk).

### Adjacent to a structure - option 3

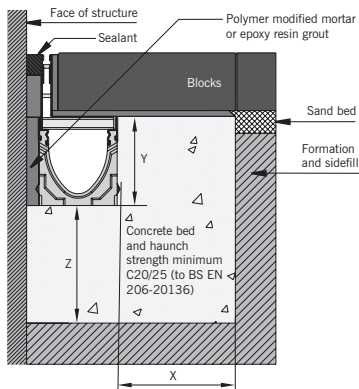

### Adjacent to a structure - option 4

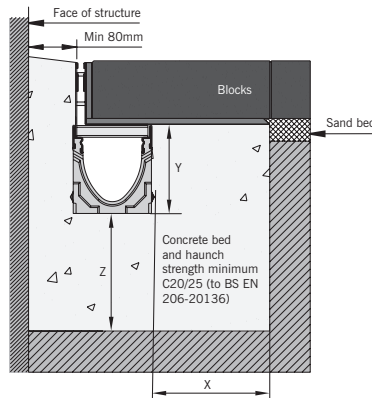

### 10.0 Watertight installation to BS EN 1433:2002

Where ACO channel joints/fittings and channel/pavement interfaces are to be sealed, an appropriate sealant must be used (e.g., Silkflex 11FC or similar). Guidance on the necessary surface preparation and/or priming should be sought from the sealant manufacturer.

See page 46 for typical method of water tight sealing.

### Best practice and workmanship

ACO can give guidance with respect to the most suitable methods of installation for each of the products in the ACO MultiDrain® MD range. ACO MultiDrain® MD should be installed using acceptable levels of workmanship and according

to the National Code of Practice (UK: BS8000: Part 14: 1989) in keeping with EN 1433:2002 (Drainage channels for vehicular and pedestrian areas).

Detailed installation statements and methodologies will vary for all sites as each will have different aspects deserving particular consideration, consequently the relevant approvals should be sought from the consulting engineer and/or the installer.

**Note: Galvanised iron and steel products have good corrosion resistance to concrete and mortar products but may experience corrosion if high chloride an/or sulphate content is present. Use only good quality concrete and consider using corrosion inhibitors where necessary. The use of protective coatings, such as paint, can minimise the risk of corrosion.**

### 11.0 Minimum Dimensions of Concrete Surround

Load Class	A 15	B 125	C 250	D 400*
Minimum Dimensions (mm)				
x	100	150	150	200
y	Full channel height (less Y2 where necessary)			
z	15 100 0	150	150	200
Y2	35	35	35	35
Maximum Dimensions (mm)	35	35	35	35
Asphalt pavement only	Y3	100	60	60

\*E.g., Parking areas for all types of road vehicle. Not suitable for carriageways of public roads or motorways.



For further information please contact our Design Services Team ([technical@aco.co.uk](mailto:technical@aco.co.uk)) or the ACO website [www.aco.co.uk](http://www.aco.co.uk)

# Chemical resistance chart

Vienite®, ACO's sustainable high strength material, has a high resistance to dilute acids and alkalis, and are unaffected by road salt, fuel and oil, and other commonly encountered chemicals. Further details of the chemical resistance can be obtained from the ACO Water Management Design Services team or, for particular chemicals, samples of the polymer concrete can be supplied to customers for their own testing. The chemical resistance will also depend on the temperature of the effluent. Clean water should not exceed 80°C.

The resistance of the gratings and edge rails should also be considered, and stainless steel gratings and edge rails are available in the ACO MultiDrain® MD system for aesthetically pleasing installations and for specific chemical resistance.

This chemical resistance chart refers to chemicals at ambient temperatures (20°C) and the results are for general guidance only.

Chemical medium	% conc	Resistance: Polyester concrete
Acetic acid, glacial	100	No
Acetic acid	10	Yes
Acetic anhydride	100	No
Acetone	10	No
Acetone	100	No
Alum	100	Yes
Aluminium sulphate	100	Yes
Ammonium chloride	100	Yes
Ammonium nitrate	100	Yes
Ammonium phosphate	65	Yes
Ammonium sulphate	100	Yes
Aniline (aminobenzene)	100	No
Barium chloride	100	Yes
Benzaldehyde	100	No
Benzene	100	No
Benzyl alcohol	100	Yes
Benzyl chloride	100	No
Borax	100	Yes
Boric acid	100	Yes
Bromine	100	No
Bromine water	Saturated	No
Butyl acetate	100	No
Butyric acid	100	Yes
Calcium carbonate	100	Yes
Calcium chloride	100	Yes
Calcium chlorate	8	Yes
Calcium hydroxide	100	Yes
Calcium nitrate	100	Yes
Carbon disulphide	100	No
Carbon tetrachloride	100	Yes
Castor oil	100	Yes
Chlorine gas, wet	100	No
Chlorine water	Saturated	No
Chlorobenzene	100	Yes
Chloroform (trichloro-methane)	100	No
Chromic acid	12	Yes
Citric acid	100	Yes
Copper chloride	100	Yes
Copper nitrate	100	Yes
Cyclohexane	100	Yes
Diesel fuel (DERV)	100	Yes
Dimethyl formamide	100	No
Dimethyl phthalate	100	Yes
Diethyl phthalate	100	Yes
Ethanol	95	No
Ethanolamine	100	Yes
Ethyl acetate	100	No
Ethylene glycol	100	Yes
Ferrous chloride	100	Yes
Ferric chloride	100	Yes
Ferrous sulphate	100	Yes
Formaldehyde	30	Yes
Formic acid	10	Yes
Formic acid	100	No
Fuel oil	100	Yes
Gasoline	100	Yes
Glycerine	100	Yes
Hydrazine	50	No

Chemical medium	% conc	Resistance: Polyester concrete
Hydrobromic acid	48	Yes
Hydrochloric acid	10	Yes
Hydrofluoric acid	10	No
Hydrogen peroxide	30	Yes
Lactic acid	100	Yes
Lead acetate	100	Yes
Magnesium chloride	100	Yes
Magnesium sulphate	100	Yes
Maleic acid	100	Yes
Methyl ethyl ketone (MEK)	100	No
Motor oil	100	Yes
Nickel chloride	100	Yes
Nickel sulphate	100	Yes
Nitric acid	5	No
Nitrobenzene	100	No
Oleic acid	100	Yes
Oxalic acid	100	Yes
Perchloric acid	10	Yes
Perchloroethylene	100	Yes
Phosphoric acid	20	Yes
Phosphorus trichloride	100	No
Potassium carbonate	50	Yes
Potassium chloride	100	Yes
Potassium dichromate	100	Yes
Potassium hydroxide	10	Yes
Potassium nitrate	100	Yes
Potassium permanganate	10	No
Potassium sulphate	100	Yes
Pyridine	100	No
Sodium acetate	100	Yes
Sodium bromide	100	Yes
Sodium carbonate	35	Yes
Sodium chlorate	100	Yes
Sodium chloride	100	Yes
Sodium hydroxide (caustic soda)	50	No
Sodium hypochlorite	18	No
Sodium nitrate	100	Yes
Sodium nitrite	100	Yes
Sodium phosphate	10	Yes
Sodium sulphate	100	Yes
Sodium sulphide	100	Yes
Sodium sulphite	100	Yes
Sodium thiosulphate	100	Yes
Stearic acid	100	Yes
Styrene	100	No
Sulphuric acid	75	No
Sulphuric acid	50	Yes
Sulphuric acid at up to 40°C	10	Yes
Tetachloroethylene	100	Yes
Thioglycolic acid	80	Yes
Thionyl chloride	100	No
Toluene	100	Yes
Toluene sulphonic acid (aqueous solution)	Saturated	Yes
Trichloroacetic acid	50	Yes
Turpentine	100	Yes
Water	100	Yes
Xylene	100	Yes
Zinc sulphate	100	Yes



## Specification clause

The surface drainage system shall be ACO MultiDrain® (Insert channel description as appropriate e.g. ACO M100D) channel system as supplied by ACO Technologies plc; all materials and components within the scope of this channel system shall be obtained from this manufacturer. The system shall be CE marked and fully compliant with BS EN 1433:2002, certificated to Load Class ( \* ) as defined in BS EN 1433:2002.

Declarations of Performance (DoP) shall be supplied to the Supervising Officer upon request. The system shall be of (100mm†, 150mm†, 200mm†) nominal internal width, manufactured in Vienite®, ACO's sustainable high strength material with cast-in (galvanised/stainless†) steel edge rails. The channels shall be installed with manufacturer's grating appropriate to the specified Load Class and locked securely in place using the manufacturer's Drainlock® boltless locking system.

The system shall be installed in accordance with the manufacturer's printed instructions, and the work carried out as specified in drawing no. (... ..) and in accordance with recognised good practice. Standards of workmanship shall generally be as specified in BS EN 752 and BS 8000:Part 14:1989.

† delete non-appropriate information.

\* insert information C 250 or D 400 as appropriate.

## Recycled content

ACO Technologies aim to incorporate as much recycled material or waste material as is practicable in their manufactured products. Typically, cast iron materials contain 40% to 90 % recycled iron, and steel products contain 25% to 33% recycled steel. The total recycled content of each product in the ACO MultiDrain® MD system will vary as the proportion of the different materials (in channels, edge rails, gratings etc) varies. As an example, ACO MultiDrain® MD channels with Heelguard™ ductile iron gratings will contain approximately 27% by weight recycled material.

The ACO MultiDrain® MD products are themselves intended for a long life with low maintenance, to reduce the need to recycle, but when eventually they are no longer needed, much of their content can be readily recycled with a very low risk of pollution to the environment.

## NBS Specifications

ACO MultiDrain® MD should be specified in section Q10:180. Assistance in completing this clause can be found in the ACO Water Management entry in NBS Plus, or please contact the ACO Water Management Design Services Team.

**Note: A specification in NBS format is available to download from [www.thenbs.com](http://www.thenbs.com) or [www.aco.co.uk](http://www.aco.co.uk)**

## Conformity

The ACO MultiDrain® MD System is fully certified to BS EN 1433:2002 and CE marked in accordance with the Construction Products Regulation.

Declarations of Performance are available via the CPR Zone on our website ([www.aco.co.uk](http://www.aco.co.uk)), or on request. Please contact ACO Water Management Design Services Team on 01462 816666 for further information.

**BS EN 1433:2002**



### General information

ACO products are subject to weight and dimensional tolerances. The weights and dimensions shown in this document are for guidance purposes only. ACO products are made from naturally occurring materials and may be subject to variations in colour, texture and marking. These aesthetic variations do not affect the performance or functionality of our Goods. The appearance of products shown in our company documentation are for illustration purposes only.

## ACO Technologies plc

- ACO Water Management  
Civils + Infrastructure  
Building + Landscape
- ACO Building Drainage
- ACO Sport
- ACO Wildlife



ISO 9001  
FM 13502



ISO 14001  
EMS 538781



OHSAS 18001  
OHS 524145

### ACO Water Management

A division of ACO Technologies plc  
ACO Business Park,  
Hitchin Road,  
Shefford,  
Bedfordshire  
SG17 5TE

Tel: 01462 816666

Fax: 01462 815895

e-mail Enquiries: [awmenquiries@aco.co.uk](mailto:awmenquiries@aco.co.uk)

e-mail Sales: [customersupport@aco.co.uk](mailto:customersupport@aco.co.uk)

e-mail Technical: [technical@aco.co.uk](mailto:technical@aco.co.uk)

website: [www.aco.co.uk](http://www.aco.co.uk)

### The ACO Group: A strong family you can depend on.

© December 2018 ACO Technologies plc. All reasonable care has been taken in compiling the information in this document. All recommendations and suggestions on the use of ACO products are made without guarantee since the conditions of use are beyond the control of the Company. It is the customer's responsibility to ensure that each product is fit for its intended purpose, and that the actual conditions of use are suitable. This brochure and any advice is provided by ACO Technologies plc (the Company) free of charge and accordingly on terms that no liability including liability for negligence will attach to the Company or its servants or agents arising out of or in connection with or in relation to this brochure or any such advice. Any goods supplied by the Company will be supplied solely upon its standard conditions of sale, copies of which are available on request. The Company's policy of continuous product development and improvement renders specifications liable to modification. Information provided in this brochure is therefore subject to change without prior notification.

#### ACO CARES ABOUT THE ENVIRONMENT

Printed on material certificated in accordance with the rules of the FSC who provide a means of assuring that products come from responsibly managed forest.