



YOUR
ENTRY
EXPERTS.

LOW LEVEL SECURITY



TWINGLOCK 900.

THE EASY **DOUBLE-WING** SIDE GATE

Simple and effective security go hand-in-hand with this double barrier access gate. The Twinglock 900 is welcoming, sleek and transparent with the benefits of multi-function used for various purposes within a small space. This access gate is wide enough for pedestrians as well as a wheelchair or delivery access, with an opening capacity of 70 – 90 degrees, depending on the access control signal received.



OVERVIEW

The Twinglock 900 can be used as a stand-alone entrance solution, especially when you have limited space available, eliminating the need for a long bank of speed gates. This space-saving solution consists of two frameless glass panels held in place by two opposing columns and a stainless steel framework on both sides. With two safety sensors incorporated in the frame, the wide lane security gate easily detects wheelchairs or large goods needing to pass through and accurately registers when the passage is clear – making the transit to the secured area an easy and comfortable one.

Its user-friendly interface allows for each solution to be operated separately or all at the same time. Moreover, the BoonTouch will show any alarm situation at the lane directly at the reception or security desk.

KEY FEATURES

- Single or multi-lane configuration possible
- Frameless, strong glass panel
- Bi-directional
- External control panel integration
- Tamper and vandal resistant
- Small footprint
- Smooth swinging-motion glass wings
- Intelligent and proven LED lights guide easy and clear passage
- Emergency egress (lock and motor disengage allowing free passage)
- Premium quality materials

FAST AND SECURE

The two glass door wings of the Twinglock 900 operate simultaneously and are smaller than the wing of the Winglock 900. This functionality makes the operation of the Twinglock 900 the fastest in the wide access gate range. The speed of the door wings is adjustable – giving you the choice of the right speed for your situation and user comfort. Advanced sensors detect tailgating attempts and promptly alert the relevant security personnel to act on the security breach.

THE POWER OF ACCESS CONTROL

This access gate can easily be added to your configuration and incorporated into our universal control panel – the BoonTouch. This remote control panel can cope with any combination of up to 6 security access solutions and is compatible with most of the solutions in our product range.

KEY BENEFITS

- Can be deployed on plinths or within the flooring
- Low carbon footprint – economical
- Audible alarm for deterring
- Adjustable opening speeds
- Wide passage for disabled access and goods delivery
- Integrates with access control systems
- Easy to clean and hygienic
- Uncomplicated to operate

SUGGESTED SEGMENTS

- Public buildings (museums, theatres, cinemas)
- Commercial buildings
- Corporate offices
- Education (universities, high school)
- Government buildings (municipality)
- Banks

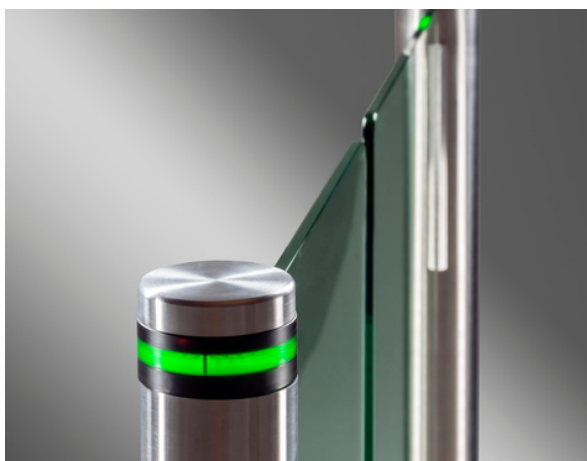

PUTTING THE POWER BACK IN YOUR HANDS

One size does not fit all, and that is why we at Boon Edam believe in offering modular solutions. This approach allows the security professional to design a tailored entrance solution that balances security and safety with aesthetics.

The result is a unique entrance that fits the needs of each industry, application and individual company. To get started, choose from an array of quality standard options. Then, 'Level Up' where it matters most to your company – whether that be in terms of throughput, security, safety, aesthetics, technology or user comfort – or a combination of each. A modular solution approach truly puts the power back into your hands - the power to create a refined entry with ease.

SCALABLE FLEXIBILITY IS THE FUTURE

The ability to integrate a large variety of secondary security technology into our access gates is the ideal way in which to fine-tune by 'Leveling Up' their entrance security when increased protection is required.

Meeting your security goal easily and within your budget is the reason why we work together with you to ensure that by using these options, you end up with a product that outperforms the others safely, beautifully and profitably.

You can level up in any of these categories:

- THROUGHPUT
- SECURITY
- SAFETY
- AESTHETICS
- TECHNOLOGY
- COMFORT
- SERVICE

LEVEL UP

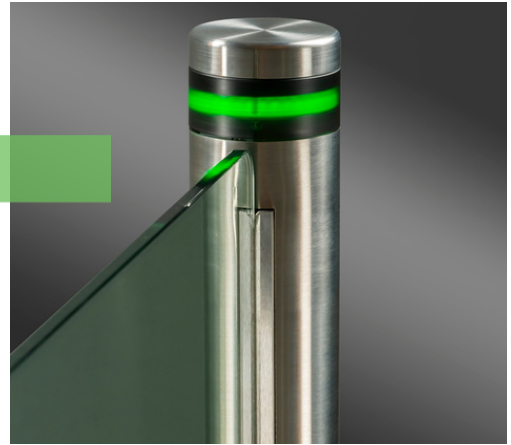

If our standard specifications do not quite suit your needs, we open up opportunities for you to 'Level Up' where it counts most. You can also do this according to your most motivating value driver:

The specification table shows you our standard product options, and to the right of these, you can easily see, and consider, any compatible 'Level Up' options for fine-tuning the Twinglock 900.



TECHNICAL SPECIFICATIONS

 THROUGHPUT	STANDARD	LEVEL UP OPTIONS
Throughput	25 - 30 People per minute	
Post Width	185 mm	
Post Height	1100 mm	
Lane Length	1220 mm	
Overall Width	1255 mm	
Passage Width	885 mm	
Number of Wings	2	
 SECURITY	STANDARD	LEVEL UP OPTIONS
Unauthorised User Detection	Complete sensor set	
Booking Signal	Adjustable booking signal	
Sound Alarm	Sound module	
Tailgating Detection	-	
 SAFETY	STANDARD	LEVEL UP OPTIONS
Fail Safe Operation	Lock will disengage in the event of a power failure	
Fire Alarm Connection	Emergency egress settings depending on local regulations and or customer request	
Emergency Opening	Wing will open	
 AESTHETICS	STANDARD	LEVEL UP OPTIONS
Wing Material	10 mm Tempered glass	
Cabinet Material	Stainless steel	
 TECHNOLOGY	STANDARD	LEVEL UP OPTIONS
Power Supply	200 - 240VAC, 24VDC	INTEGRATION OPPORTUNITIES: <ul style="list-style-type: none"> BoonTouch External Control Panel (up to 6 lanes)
Operating Power	75W	
Operating Temperature	-20°C to +50°C	
Weight	100 kg	
Access Control Systems	Dry contacts for virtually any access control device	
Card Reader Mount	On end post	
 COMFORT	STANDARD	LEVEL UP OPTIONS
Disabled Access	The standard passage width allows for disabled access	
Stand-by Power Consumption	Stationary 9W	

6 WORKING PRINCIPLE

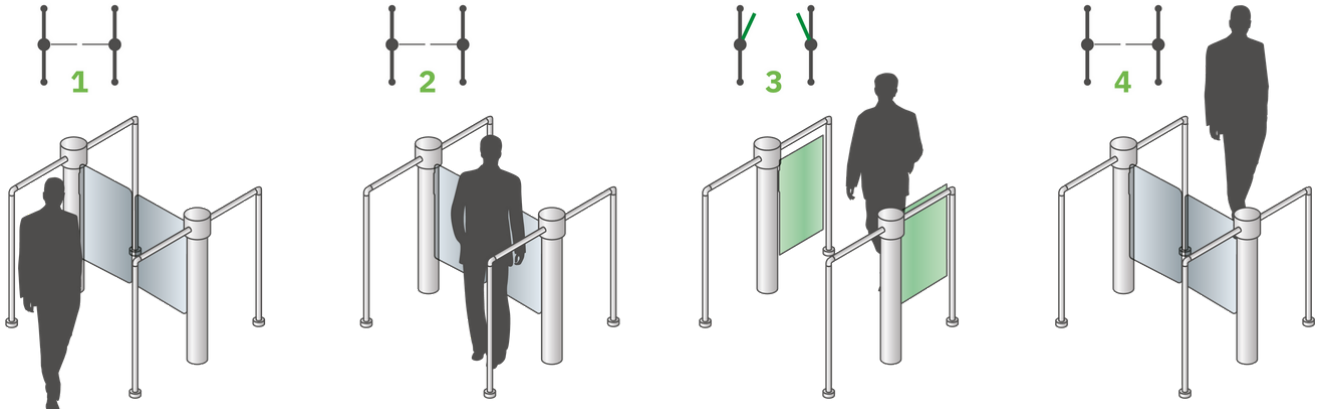

TECHNICAL DIMENSIONS

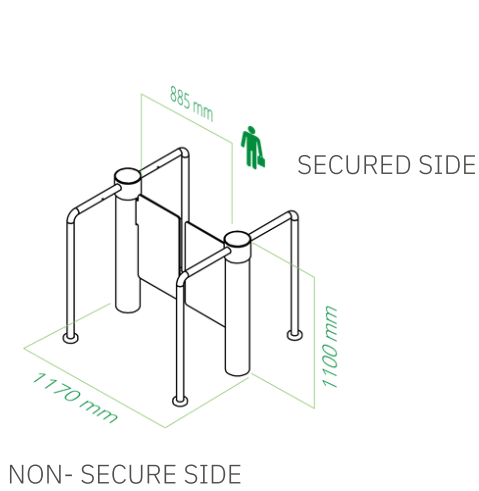

SECURED SIDE

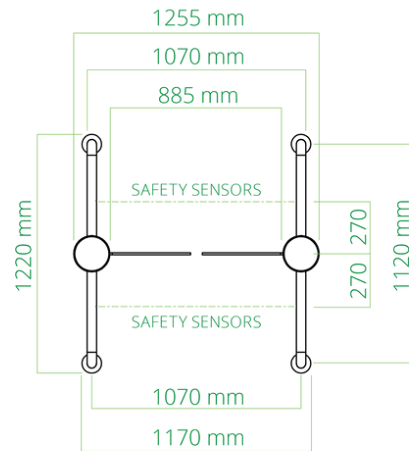

NON- SECURE SIDE

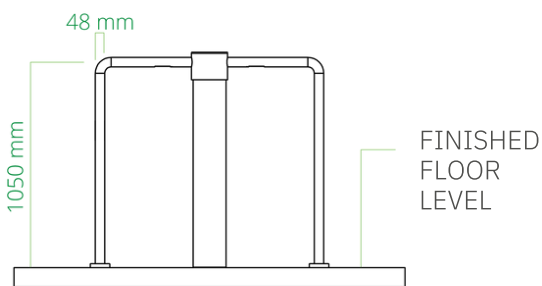

SIDE VIEW

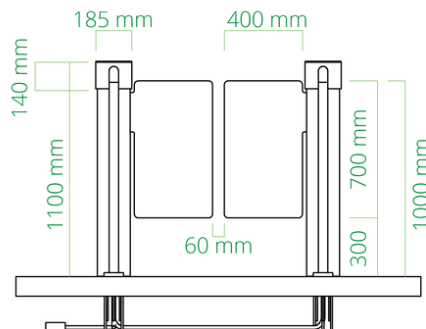

NON- SECURE SIDE



SERVICE AND MAINTENANCE

With hundreds or thousands of visitors passing through an entry every day, continued and reliable operation is vital. Regular service and maintenance can prevent unexpected hardware breakdowns. Boon Edam's service and maintenance teams across the world are experienced in the effects the local conditions have on the wear and tear of your entry solutions and can offer specialised service and maintenance contracts that correspond to those conditions perfectly.

COMPLIANCE

The goal of an organisation is to safeguard the valuable assets inside – both people and property. As is often the case, industries must comply with relevant local and global laws, policies and regulations, to achieve the important goal of overall safety and security. Failure to meet the appropriate measures and criteria set out in these regulations could result in catastrophic incidents and substantial fines.

Boon Edam security entrances are trusted solutions that allow organisations to meet compliance regulations related to restricting access to areas within a building. We take compliance and safety very seriously and ensure that our products are manufactured, installed and maintained to keep up the strict criteria required in all our countries. We are always improving and committed to making sure our products are compliant and certified. More information can be found on our website under 'About Us'.



OUR REACH IS GLOBAL.

We have been in business for more than 140 years manufacturing premium aesthetic and security entrance solutions in the Netherlands, United States of America and China. We can confidently say that we cover every corner of the globe with subsidiary companies in major cities across the globe. Furthermore our global export division not only partner with our distributors, but also offer direct sales and service to every territory. This wide net allows us to have a strong global footprint as well as a personal grasp of local markets and their unique entry requirements.

To find your closest Boon Edam expert, please go to:
www.boonedam.co.uk/contact



Boon Edam Limited.
T 01233 505 900
E uk.sales@boonedam.com
I www.boonedam.co.uk

BOON EDAM
YOUR ENTRY EXPERTS.