

## Washroom Additions

complementary systems for your washroom environment



Completing  
the washroom  
environment

## Contents

### Duct Systems

Standard Duct System  
Duct+ Pre-assembled System

04



### Vanities

High Pressure Laminate  
Solid Grade Laminate  
Premium Surface  
Handwash Trough

08



### Lockers

12



### Benching

13



### Hardware

14



### Accessories

15



## Washroom Additions



Add that finishing touch to your washroom, cloakroom or changing area with our range of complementary vanity, duct, locker and benching systems and accessories.

Providing bright, fresh and hygienic washrooms is simple using our duct and vanity systems to conceal plumbing and services. All of our systems co-ordinate to provide consistent colour themes and stunning finishes.

We also supply complementary cloakroom solutions to complete your washroom project. Our range of high quality locker and benching systems can be specified with matching colours to complete your design theme.

Browse a variety of quality accessories to complete your new washroom or select extra hardware components - available from stock or on short lead times.

Whatever your requirement, call us, we'd love to hear from you  
**01603 424 855**



# Duct Systems

Our highly versatile duct systems are manufactured bespoke to each project. Primarily used to conceal plumbing, duct systems provide a hygienic, stylish and tidy solution to your washroom, surgery or medical room requirements. Available in a choice of materials, heights, colours and in two variants for simple installation and guaranteed quality finish.

## Duct System

Made to measure, supplied in component form.

## Duct+ System

Made to measure, supplied in assembled modules.





# Duct+ System Overview



### Factory assembled framework

“Saves time on site and means we no longer have to worry about getting the timber framework made up”

### Pre-fitted panelclips

“Great system, saves us 50-55% on site installation times. Having all panel clips pre-fitted is a massive help”

### Simple, modular installation

“I didn't believe it could be so simple. We can now use less skilled labour on site due to the modular construction.”

### Guaranteed panel alignment

“I always specify Duct+, it means I can be sure of a top quality finish with no missaligned panels”

## System Comparison

### Dunhams Supply

- › Access panels
- › Pre-grooved shadow panels to take removeable clips
- › Shadow baton and panel fixings

### Installer Supply

- › Timber framework constructed to Dunhams drawings
- › All framework fixings
- › Plinth)

### Duct System

### Duct+ System

- › Pre-constructed framework with all access panels factory fitted
- › Shadow batons to be fitted between frames
- › Plinth
- › All necessary brackets & fixings to fix frames in position.

- › Extra supports for wall hung sanitaryware (if required)

# Specifications



### Panel Material

- › 18mm high pressure laminate
- › 13mm solid grade laminate

### Detail

- › SGL panels with polished & radiused edges
- › HPL panels lipped in 2mm ABS
- › Concealed clip fixings
- › Factory laminated shadow strips
- › Grooved shadow strips for easy clip fixing

### Finishes

- › Selected from Dunhams Colour Selector

### Options

- › Postformed vertical edges - HPL only
- › Variable shadow detail

### Duct+ Option

- › Access panels pre-fitted to factory constructed modular ply sub-frames for fast and simple site installation

### Full Height Duct Configurations

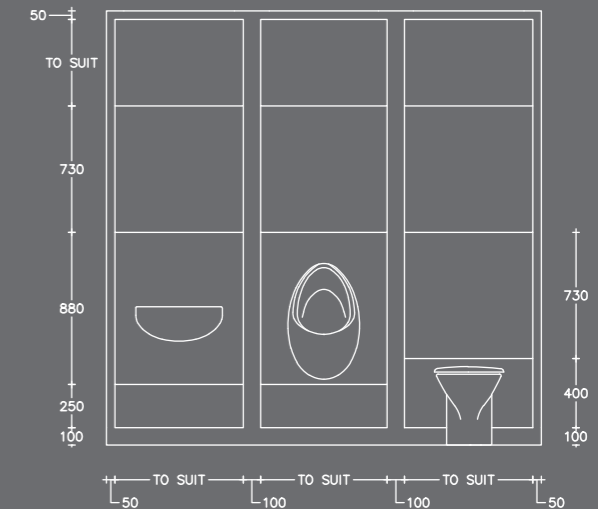

### Cubicle Height Duct Configurations

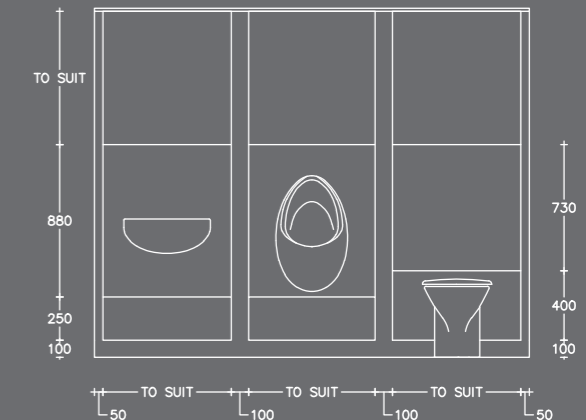

### Low Level Duct Configurations

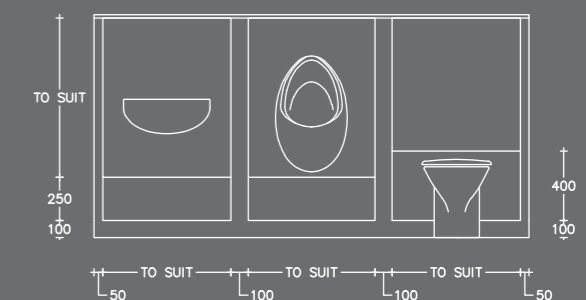

# Vanities

## High Pressure Laminate - HPL)

Attractive, practical and cost-effective solution using HPL High Pressure Laminate. Postformed downstand and covered rear upstand as standard design. Available to suit semi-recessed or inset basins.

Supplied with HPL or SGL access panel system pre-fitted on sub-frames.

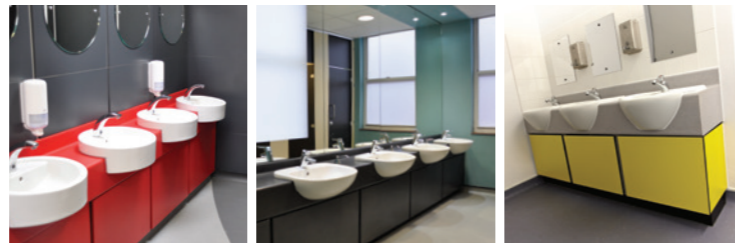

## Solid Grade Laminate - SGL)

Ultimate performance in high traffic and wet area washrooms. Manufactured from SGL Solid Grade Laminate for durability. Available to suit semi-recessed, inset or undermount basins.

Supplied with SGL access panel system pre-fitted on sub-frames.



## Premium Surface

Luxurious vanity tops for upmarket and high traffic washrooms. Manufactured from stone, quartz or solid surface materials to client specification. Seamless moulded bowls available in solid surface option.

Available in various designs, either wall-mounted or with sub-frame and access panels.



## Handwash Trough

Stylish, hygienic and versatile handwash solutions for busy washroom areas. Manufactured from solid surface material - a non-porous blend of natural minerals and acrylic polymers.

Available in various designs, either wall-mounted or with sub-frame and access panels.



# Specifications

## High Pressure Laminate - HPL

### Top Construction

18mm High Pressure Laminate with postformed upstand and downstand.

### Unit Construction

Factory constructed plywood subframe, pre-fitted with either 13mm SGL or 18mm HPL access panels.

### Options

- › Low height options available
- › Custom size upstand downstand
- › Unit options as opposite page

### Fully Recessed HPL

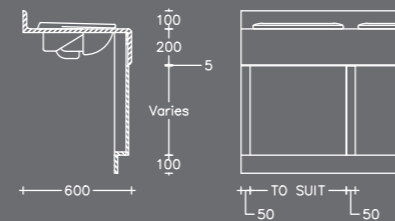

### Semi-Recessed HPL

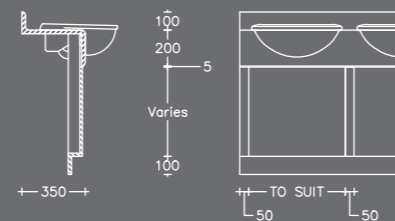

## Solid Grade Laminate - SGL

**Top Construction** - 13mm Solid Grade laminate. Square butt jointed upstand and downstand with thumbnail radius to exposed edges.

**Unit Construction** - Factory constructed plywood subframe, pre-fitted with either 13mm SGL or 18mm HPL access panels.

### Options

- › Low height options available
- › Custom size upstand downstand
- › Unit options as opposite page

### Fully Recessed SGL

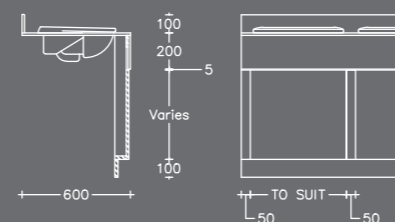

### Semi-Recessed SGL

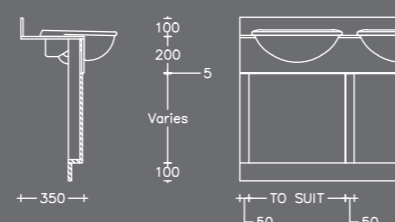

## Premium Surface

**Top Construction** - Granite, Quartz or Corian fabricated to clients requirements.

**Unit Construction** - Factory constructed plywood subframe, pre-fitted with either 13mm SGL or 18mm HPL access panels.

### Options

- › Low height options available
- › Unit options as opposite page

### Solid Surface

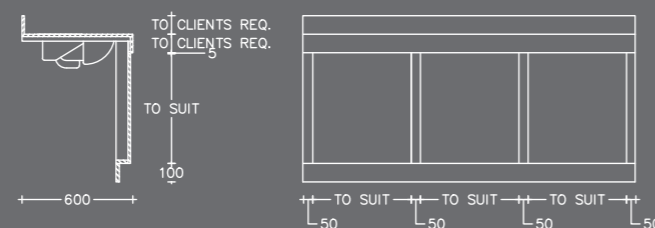

## Handwash Trough

**Top Construction** - Solid surface fabricated around MDF substrate.

**Unit Construction** - Factory constructed plywood subframe, pre-fitted with either 13mm SGL or 18mm HPL access panels.

### Options

- › Low height options available
- › Custom design troughs available
- › Unit options as below

### Tap Deck Trough

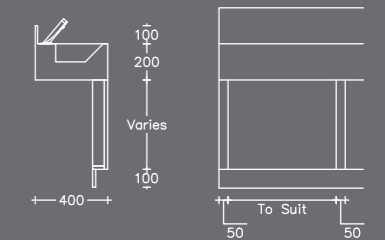

### Splash Back Trough

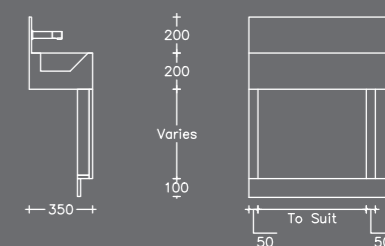

## Unit Options

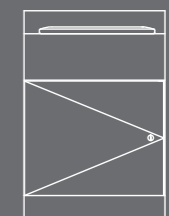
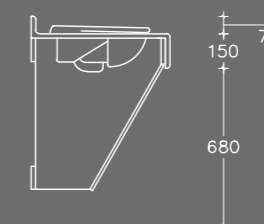
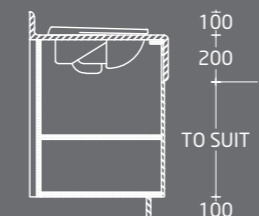

### Carcass with Shelves

**Unit Construction** - 18mm MFC carcass, cam and dowelled construction, supplied fully assembled with hinged doors.

### Options

- › Low height options available
- › Lockable doors

### Sloped Under-panel

**Unit Construction** - Factory assembled ply subframe with sloped under panels for access.

### Options

- › Low height options available

### Hinged and Lockable Door

**Door Construction** - HPL or SGL panels supplied pre-hung on sprung cabinet hinges with key operated cam lock.



# Locker and Bench Systems



Designed and manufactured for durability, our locker and bench systems offer exceptional long-life solutions for cloakroom and changing areas.

Solid Laminate locker doors and bench seats can be specified in the same colours as your washroom furniture to create stunning and consistent design themes throughout your project.

Available to suit wet or dry areas.

## Locker Specification

**Door Specification** - 10mm Solid Grade Laminate, polished and radiused edges with profiled corners.

### Carcass Specifications

**Dry area** - Mild steel construction with powder coated finish with coat hook to each compartment.

**Wet area** - Anodised aluminium outer shell with heavy duty plastic shelves and coat hook to each compart.

**Wet area SGL** - Full 13mm SGL construction with ventilation slots and coat hooks to each compartment.

### Options

- › SGL end panels and lids
- › Locking options including key operated, coin return, hasp and combination locks
- › Door numbering

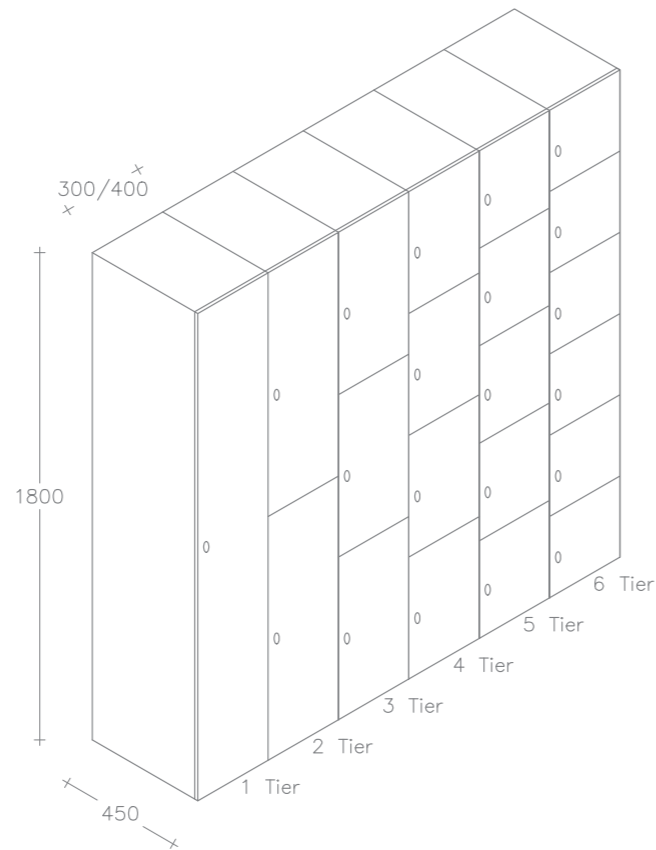

## Bench Specification

### Frame Specification

38mm steel box section.  
Fully welded, zinc treated and polyester powder coated finish.

### Seat Specification

- › Matching hookboards and backrests
- › Adjustable foot fixing
- › Shoe trays
- › Shelving

### Options

- › Stainless steel frames
- › Matching hookboards & backrests
- › 20mm SGL slats

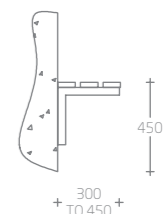
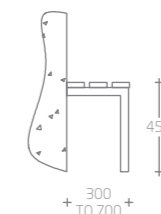
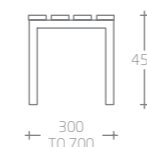
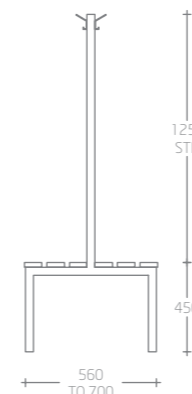

### Island

Double sided island bench complete with integrated hookboard and backrest.

### Free-standing

Freestanding bench suitable for back to wall and island applications.

### Wall to floor

Wall to floor bench for back to wall applications.

### Cantilever

Cantilever bench for back to wall applications.

# Hardware



### Indicator Bolt

- › Solid aluminium construction
- › Through fixed face plate
- › Satin or polished finish
- › Available for 13-20mm panels



### Pedestal

- › Solid aluminium construction
- › Satin or polished finish
- › Available for 13-20mm panels
- › Available in 25mm, 100mm and 150mm floor clearance

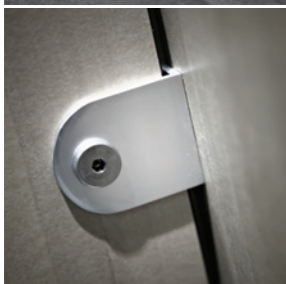

### 13mm Panel Cleats

- › Solid aluminium construction
- › Satin or polished finish

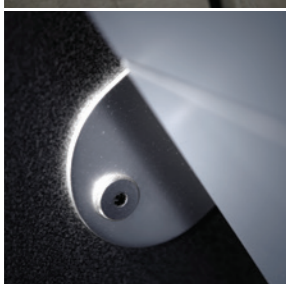

### 18mm Panel Cleats

- › Solid aluminium construction
- › Satin or polished finish

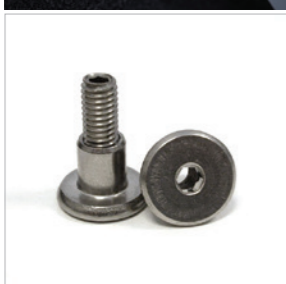

### Interbolts

- › Stainless steel construction
- › Provide secure through fixing
- › Available with security heads
- › Available for 13-20mm panels



### 13mm Hinge

- › Solid aluminium construction
- › Twin bolt through fixing
- › Satin or polished finish
- › Available for 13mm panels



### 18mm Hinge

- › Solid aluminium construction
- › Panel edge fixing for HPL and MFC panels
- › Satin or polished finish
- › Available for 18mm panels



### Headrail

- › Extruded aluminium construction
- › Satin or polished finish
- › Suitable for 13-20mm panels

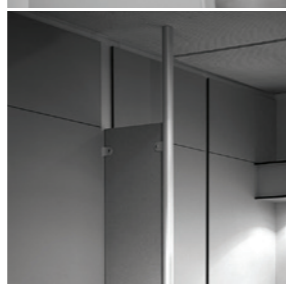

### Floor-to-ceiling Mount

- › Solid aluminium construction
- › Satin or polished finish
- › Available in various configurations for 13-20mm panels
- › Suitable for ceiling heights up to 3000mm



### Panel Clips

- › Durable Polycarbonate construction
- › Available in lift-off or pull-off configurations
- › Suitable for 13-20mm panels

# Accessories



### Straight Grab Rails

- › 304 grade stainless steel
- › Satin finish as standard
- › White/navy metal on request
- › Lengths mm - 450, 600, 750, 900, 1000, 1200



### Doc M Pack

- › 304 grade stainless steel
- › Satin finish as standard
- › White/navy metal on request
- › Contents: 3nr 600mm rails, 1nr hinged rail, 1nr backrest



### Toilet Tissue Dispenser

- › Durable construction
- › White plastic finish
- › Available in 8, 10 and 12 inch diameters



### Hand Towel Dispenser

- › Durable construction
- › White plastic finish
- › Capacity of approx 750 folded sheets



### Soap Dispenser

- › Durable construction
- › White plastic finish
- › Refillable reservoir
- › 400ml, 1000ml and 2000ml capacities available



### Baby Change Stations

- › Durable plastic construction
- › Available in white and grey
- › Dimensions: 510mm(h) x 872mm(w) x 513mm(d) when open x 102mm(d) when closed
- › Capacity; tested to 100kg

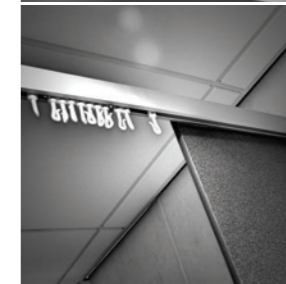

### Shower Curtain Rail

- › Extruded aluminium construction
- › Anodised finish as standard
- › Supplied with roller wheel curtain hooks
- › Available made to measure in various configurations



### Toilet Tissue Dispenser SS

- › Durable construction
- › Brushed stainless steel finish
- › Available in 10 and 12 inch diameters



### Hand Towel Dispenser SS

- › Durable construction
- › Brushed stainless steel finish
- › Capacity of approx 500 folded sheets



### Soap Dispenser SS

- › Durable construction
- › Brushed stainless steel finish
- › Refillable reservoir
- › 900ml capacity





# We have a washroom range to suit every style and situation...

## **Kinder**

Low-height cubicles in vibrant colours and shapes

## **Junior system**

Robust kids' cubicles with shaped doors and partitions

## **Classic**

Versatile modular HPL system, ideal for busy areas

## **Challenger**

SGL system for ultimate durability

## **Altitude**

Floor to ceiling aesthetics for increased privacy

## **Aspect**

Contemporary designs with flowform aluminium pilasters

## **Vista**

Luxury flush-façade cubicles in rebated solid grade laminate

## **Washroom Additions**

Duct panelling, vanity units, lockers and benching

Each range is manufactured to suit specific project requirements and is delivered pre-drilled in easy-install form. Our systems have been developed by working closely with architects, designers, specifiers and contractors over the last 40 years. Attention to detail, quality and above all, client care and service are included as standard.



**Dunhams**  
washroom systems

call 01603 424855 fax 01603 413336 email [info@dunhamsofnorwich.co.uk](mailto:info@dunhamsofnorwich.co.uk)  
Dunhams The Granary School Road Neatishead NR12 8BU