

FIS

FINISHES & INTERIORS SECTOR



SCI
Steel Knowledge

TECHNICAL REPORT ED017

DESIGN AND INSTALLATION OF LIGHT STEEL EXTERNAL WALL SYSTEMS



www.thefis.org

www.steel-sci.com



FINISHES & INTERIORS SECTOR



TECHNICAL REPORT ED017

DESIGN AND INSTALLATION OF LIGHT STEEL EXTERNAL WALL SYSTEMS

Copyright © 2019 The Steel Construction Institute (SCI)
and Finishes and Interiors Sector Limited (FIS)

Apart from any fair dealing for the purposes of research or private study or criticism or review, as permitted under the Copyright Designs and Patents Act, 1988, this document may not be reproduced, stored or transmitted, in any form or by any means, without the prior permission in writing of the publishers, or in the case of reprographic reproduction only in accordance with the terms of the licences issued by the UK Copyright Licensing Agency, or in accordance with the terms of licences issued by the appropriate Reproduction Rights Organisation outside the UK.

Enquiries concerning reproduction outside the terms stated here should be sent to SCI or FIS, at the addresses given on the back page.

Although care has been taken to ensure, to the best of our knowledge, that all data and information contained herein are accurate to the extent that they relate to either matters of fact or accepted practice or matters of opinion at the time of publication, SCI or FIS, the authors and the reviewers assume no responsibility for any errors in or misinterpretations of such data and/or information or any loss or damage arising from or related to their use.

CONTENTS

Foreword	5	7 Health and safety	22
Summary	6	7.1 Edge protection	22
1 Introduction	7	7.2 Manual handling	22
1.1 Background	7	7.3 Cutting	23
1.2 Scope	7	7.4 Method statements	23
1.3 External wall systems	8	7.5 Risk assessments	23
2 Light steel sections	10	7.6 Access equipment	23
2.1 Steel grade and coatings	10	8 Continuous walling	25
2.2 Section sizes	10	8.1 Connection to structure	25
3 Structural design	12	8.2 Splices	25
3.1 Loads	12	8.3 Openings for doors and windows	25
3.2 Design resistance	13	9 Secondary steelwork	26
3.3 Cladding loads	14	9.1 Wind posts	26
3.4 Deflections	14	9.2 Projection brackets	26
3.5 Openings	15	9.3 Projection of windows	26
3.6 Detailing around primary frame bracing	15	10 Special cases	27
3.7 Holes in members	16	11 Checklists	28
3.8 Splices	16	11.1 Checklist for external wall designers and specifiers	28
3.9 Load tables	16	11.2 Checklist for external wall supplier	28
4 Setting out, tolerances and movement ...	17	11.3 Checklist for main contractors	28
4.1 Setting out	17	11.4 Checklist for erection supervisors	29
4.2 Installation tolerances	17	11.5 Checklist for infill wall manufacturer	29
4.3 Openings for windows and doors	17	12 Site audit report	30
4.4 Deflection head detail	18	13 Reference	31
5 Fixing details and fasteners	19	14 Acknowledgments	33
5.1 Fixing details	19		
5.2 Types of fastener	19		
6 Installation	20		
6.1 Site preparation	20		
6.2 Basic installation principles	20		

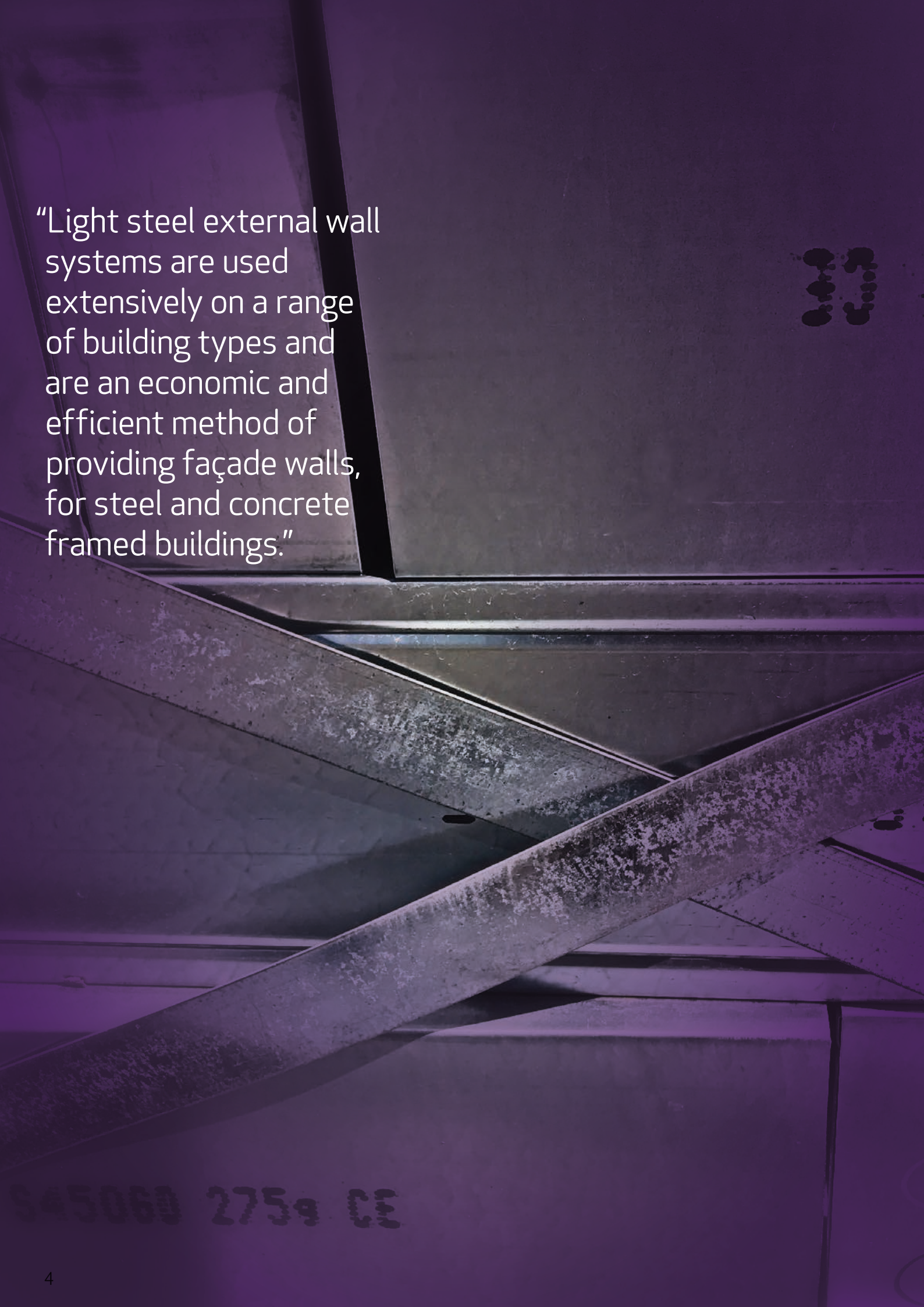

“Light steel external wall systems are used extensively on a range of building types and are an economic and efficient method of providing façade walls, for steel and concrete framed buildings.”

FOREWORD

Light steel external wall systems are used extensively on a range of building types and are an economic and efficient method of providing façade walls, for steel and concrete framed buildings. There are three generic types of light steel external wall system: infill; continuous; and panelised. Light steel external walling is capable of resisting wind loads and supporting a range of cladding types. This report has been prepared to provide guidance on the design and installation of light steel external wall systems.

This revised guidance was carried out in conjunction with Steel Construction Institute (SCI) and Finishes and Interiors Sector Limited (FIS) SFS Special Interest Forum.

The original report was prepared by Andrew Way and Mark Lawson, both of SCI, with the support and guidance of the Light Steel and Modular Framing Group. It responds to the need to complement the general guidance on the design of light steel sections provided in **Structural Design to BS 5950-5: 1998, Section Properties and Load Tables (P276)** ¹ and **Design of Light Steel Sections to Eurocode 3 (ED005)** ² by giving guidance on their application in external walling systems.

The Light Steel and Modular Framing Group now operates as the Light Steel Forum, an industry sector group managed by the SCI. The group was set up in 1993 to develop and promote the use of light steel construction through a wide range of technical and educational activities. The Light Steel Forum is supported by leading manufacturers in the light steel sector and is assisted by participation of plasterboard manufacturers and specialist consultants involved in the technology. www.lightsteelforum.co.uk

FIS SFS Special Interest Forum was formed by manufacturers, engineers, suppliers and contractors involved in the design, supply and construction of light gauge steel structures and façades, also known as steel framed systems (SFS).

Bringing industry together allows us to recognise the common issues around skills, education and understanding within the specification sector. By highlighting these issues the industry who are best-placed to advise on all these points can, with the help of FIS, pursue a programme of engagement and education.

The work leading to the original report was funded by Ayrshire Metals Ltd, BW Industries Ltd, Fusion Building Systems, Kingspan Steel Building Solutions, Metek Plc and Tata Steel Strip Products UK.



This revised guide has been supported by Acoustic and Insulation Manufacturing Ltd, Caledan, EOS Facades Ltd, Etag Fixings UK Ltd, Etex Building Performance Ltd, Euroform Products Ltd, Knauf Ltd, Stanmore Contractors Ltd, Trimble Solutions (UK) Ltd, Veitchi Group Ltd, Vertex Systems Oy and voestalpine Metsec Plc.



¹ ² <https://portal.steel-sci.com/documents.html>

SUMMARY

This technical report provides guidance on the design and installation of light steel external wall systems. Guidance on all aspects of light steel external wall systems is provided, including:

- Choice of steel sections
- Structural design issues
- Setting-out, tolerances and provision for movement
- Fixing types and their spacing
- Installation
- Health and safety
- Secondary steelwork
- Special design cases
- Checklists for designers and installers.

Detailed structural design guidance for light steel sections is not provided in this report. Guidance on the detailed structural design of light steel sections is given separately in ***Structural Design to BS 5950-5: 1998, Section Properties and Load Tables (P276)*** ¹ and ***Design of Light Steel Sections to Eurocode 3 (ED005)*** ².

1 INTRODUCTION

1.1 Background

Light steel external walling is used extensively on a range of building types and is an economic and efficient method of providing an external wall system, for steel and concrete-framed buildings, that is capable of resisting wind loads and supporting a range of cladding types.

The need for this report was originally established during discussions at meetings of the Light Steel Forum. The group identified the need for practical guidance on light steel external walling that was aimed at:

- Assisting specifiers to understand the design and installation requirements
- Ensuring best practice is adopted in design and installation
- Providing guidance on detailing
- Special design cases such as long windows and parapet walls.

It was recognised that it was in the interest of the sector to produce an industry accepted document that would help to inform all concerned in this rapidly developing steel technology.

The report is intended to educate specifiers and contractors who may not be familiar with light steel external wall technology and the aspects of design and installation that are considered to be recommended practice.

The target audience of the report is identified as:

- Main contractors
- Architects
- Structural engineers
- Installers
- Manufacturers.

1.2 Scope

The guidance in this report covers the following aspects:

- Design of members in light steel external wall systems
- Detailing of openings for doors and windows
- Installation of light steel external walls in framed buildings
- Interfaces, including to cladding and the supporting structure
- Interaction with other trades eg drylining, services, brickwork, external cladding systems, etc
- Health and safety during installation.

Three generic types of light steel external wall systems are covered:

- Infill walls (so called stick-built, on-site)
- Continuous walls (stick-built, on-site)
- Panelised systems (prefabricated, often with sheathing attached).

Variants of standard walls considered are:

- Curved walls
- Ribbon windows
- Parapets and downstands
- Braced walls (in the same line as the infill walling)
- Inclined walls and soffits
- Balconies and patio walls.

Cladding systems are covered, in so far as they affect the design of the light steel walls. The following common types of cladding are covered:

- Ground supported brickwork, and brickwork supported at each floor
- Insulated render (generally attached to sheathing boards)
- Rainscreen cladding systems (eg tiles, boards, metallic sheets, generally using sheathing boards attached to the light steel external wall system)
- Granite tiles and other high load systems
- Brick slips.

1.3 External wall systems

In multistorey framed construction, it is common practice to use light steel external wall systems to create a 'rapid dry envelope' supporting the external cladding. The use of light steel external wall systems may be applied to any type of framed construction in steel or concrete. It is lightweight and provides speed and ease of installation as important constructional benefits.

There are three generic types of light steel external wall systems:

- Infill walls
- Continuous walls
- Panelised systems.

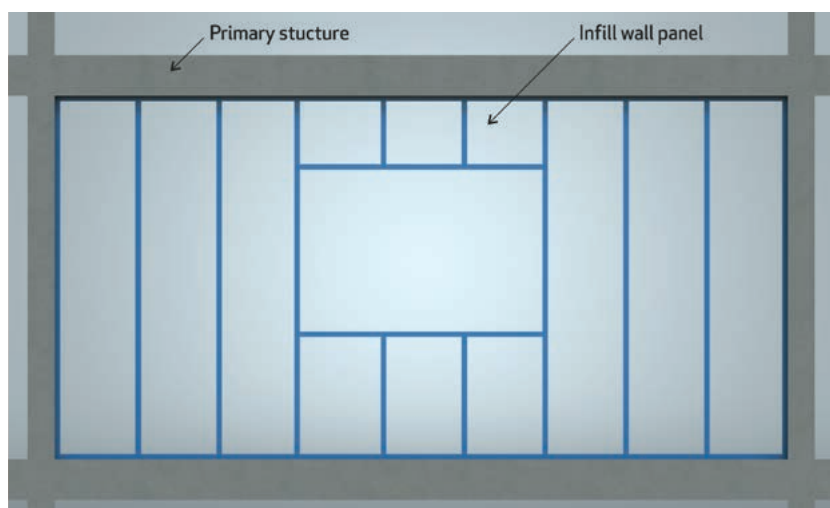

Figure 1.1 Typical infill wall panel within a steel or concrete primary structure

“Light steel external wall systems must be installed by companies which are fully conversant with the system being installed and can demonstrate competency.”

Infill walls

The panels for infill walls are generally constructed from individual elements, which are cut to length and installed on site (so called stick-built). The panels fit between the elements of the primary structural frame, as shown in figure 1.1. The panels consist of a bottom track attached to the floor and a head track attached to the underside of the floor above. Vertical light steel C sections are fitted between the head and base tracks, typically at 600mm centres (or reduced to 400 or 300mm where structural design requires closer spacing). In some cases, the panels may be constructed such that they project past the edge of the primary structure (see figure 9.2).

Continuous walls

The continuous wall panels (also known as over-sail panels) are placed externally to the primary structural frame, as shown in figure 1.2. The system consists of vertical light steel C sections and bracket connections used to fix the C sections to the primary frame.

Panelised systems

The panelised system uses prefabricated light steel wall panels, often with insulation and boards attached off-site. These are craned into position and fixed to the primary structural frame (see figure 1.3).

Light steel external wall systems must be installed by companies which are fully conversant with the system being installed and can demonstrate competency. The company must provide evidence that they are appropriately qualified to a recognised standard. This may be either academic, vocational or experience qualification based on review by an approved assessor. The installers will generally be working as subcontractors to the main contractor who is responsible for the construction of the building.

The vertical elements of the light steel external wall systems are designed to either span storey to storey, oversail or be constructed off-site. As external walls,

they are designed to resist wind loading on the façades, and to support their own weight and that of attached lightweight cladding materials. Dead weight of masonry cladding must be supported directly by the primary structure or foundations.

However, light steel external wall systems can generally provide horizontal support against wind through the inclusion of a proprietary system of brick tie channels and brick ties positively fixed back to the stud. In addition to structural requirements, the design of external wall systems must also consider fire resistance, condensation risk, weathertightness, thermal insulation and acoustic performance, and must allow for interfaces at windows, patio door and balconies, etc.

The focus of this report is on non-loadbearing infill walls which consist of assemblies of site-installed sections; although much of the guidance will also apply to continuous walls and panelised systems.

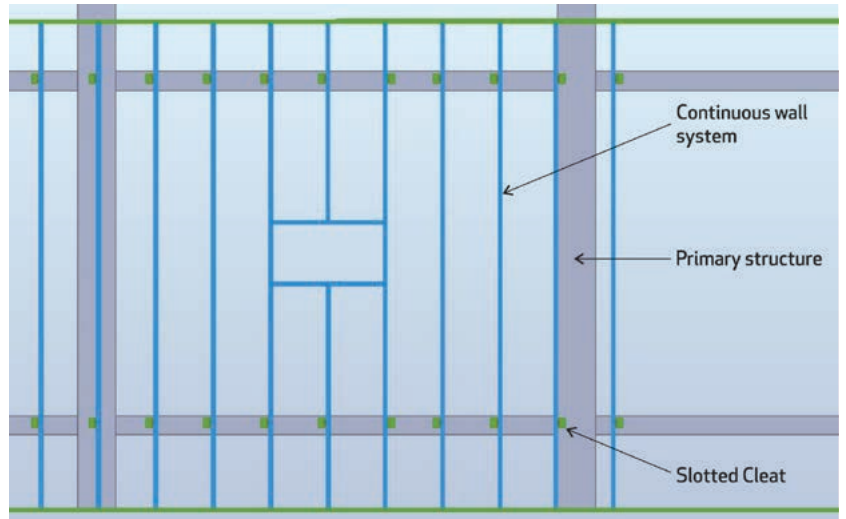

Figure 1.2 Typical continuous walling fixed external to the primary structure – some openings may require compound stud framing, refer to the designer/manufacturers details

Figure 1.3 Typical prefabricated panelised external infill wall system



“...the design of external wall systems must also consider fire resistance...”

2 LIGHT STEEL SECTIONS

2.1 Steel grade and coatings

External wall systems perform the significant structural functions of resisting wind load and supporting the weight of cladding systems. Therefore, it is important that the systems have been adequately designed, and in order to justify the structural design the components must be formed from suitable quality steel designed for use in SFS.

Recommended steel grades for external walls are S350, S390, S420 and S450. Mechanical properties for these steel grades are given in Table 2.1.

Recommended steel grade	Minimum yield strength N/mm ²	Minimum tensile strength N/mm ²	Minimum elongation %
S350GD	350	420	16
S390GD	390	460	16
S420GD	420	480	15
S450GD	450	510	14

Table 2.1 Mechanical properties of recommended steel grades

Steel studs from the drylining sector are not suitable for use in SFS. Steel grades used for drylining partitions, such as DX51, must not be used for external walls, as they are not structural grade steels.

For durability of light steel external walling, steel sections should have a minimum zinc coating of Z275 in accordance with **BS EN 10346: 2015** ³. A minimum aluminium-zinc coating of AZ150 in accordance with **BS EN 10346: 2015** ³ is also acceptable. Galvanized coating Z275 (275g/m²) is equivalent to 0.02mm on each face of the steel sections.

The predicted design life for light steel sections in external wall systems with Z275 coating is 250 years when used within a 'warm-frame' environment. The predicted design life is based on data collected from buildings across Europe and is explained in **SCI publication P262 (2nd edition)** ⁴

2.2 Section sizes

The gauge and dimensions of the sections to be used in construction must be verified by project-specific structural calculations. The structural design may be carried out in accordance with **BS 5950-5** ⁵ or **BS EN 1993-1-3** ⁶. The principle designer, representing the client as defined in the CDM Regulations, should indicate which code should be used. Mixing of codes is not acceptable.

The type of section used in external wall systems is generally either a plain C section (also known as U sections) or a lipped C section (see figure 2.1). The section sizes used for external wall applications will depend on the structural design (ie the size of sections required to provide sufficient strength and stiffness) and on practical considerations of ease of construction and fixing other elements of the system to the sections.

The main members used in an infill wall panel are shown in figure 2.2. Lipped C sections are used for the vertical elements and plain C sections are used for the horizontal

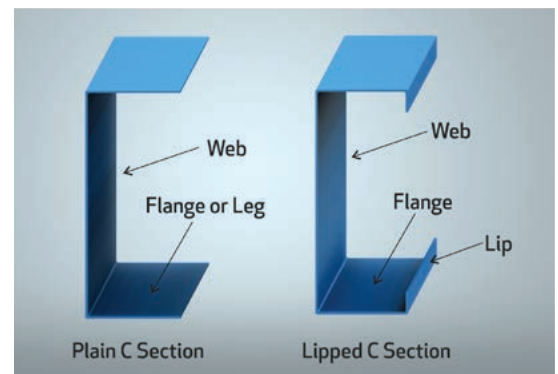

Figure 2.1 Types of steel section

tracks at the top and bottom of the panel. Members should be clearly marked with the manufacturer's name and steel gauge to aid identification and ensure that the correct section sizes are used as required by the structural calculations.

Base track

The base track should be formed from a plain C section with a leg length (flange width) of at least 32mm.

³ <https://shop.bsigroup.com/ProductDetail/?pid=00000000030280396>

⁴ <https://portal.steel-sci.com/documents.html>

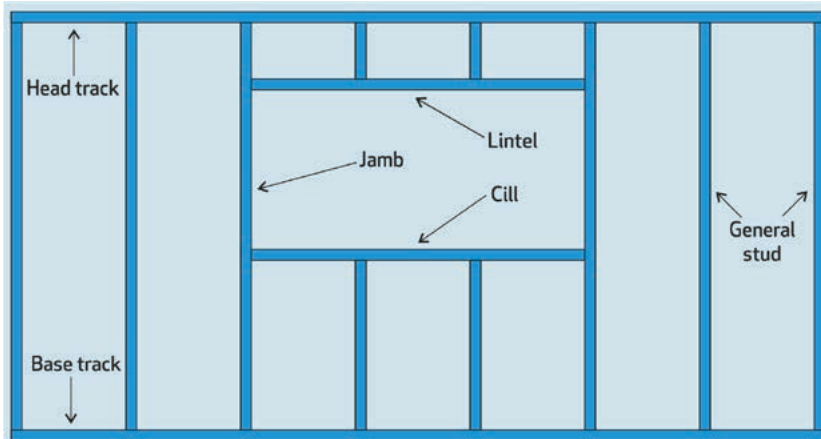

Figure 2.2 Main sections of an infill wall panel

The width of the base track should be suitable to receive the vertical C sections. The internal dimension between the flanges of the track should be equal to the external width of the vertical C section, as shown in figure 2.3.

The minimum recommended steel thickness for the base track is 1.2mm.

Head track

To allow the floors of the primary structural frame to deflect during service without inducing axial loads into the infill wall, the head tracks must incorporate a deflection head detail (see section 4). The head track should be formed from a plain C section with a leg length (flange width) of sufficient size to allow for positive and negative deflection.

The width of the head track should be suitable to receive the C section vertical members. The internal dimension between the flanges of the track should be equal to the external width of the C section, as shown in figure 2.3.

Head track members should be designed to suit the load and allow for deflection and construction tolerances. The head track might be a different gauge to the stud and bottom track. Ensure that the correct gauge components are being used. Refer to the design drawings at all stages.

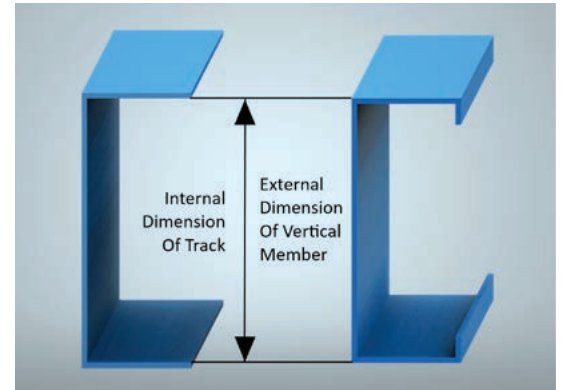

Figure 2.3 Key relative dimension of tracks and vertical members

Studs, lintels and cills

The vertical members (studs) are generally formed from lipped C sections (with edge stiffeners as shown in figure 2.1). The depth of C sections (web dimension) typically varies from 70mm to 300mm (although 100 and 150mm are the common dimensions).

The size of C section to be used should be determined from structural design.

The size of lip should be at least equal to the flange width divided by five, and at least 10mm.

The recommended minimum steel thickness for studs, lintels and cills is 1.2mm.

The recommended minimum width (flange dimension) of the C sections depends on the fixing of the boards attached to the wall panels. The C section flange width should be sufficient to allow for two boards to be fixed to it, as shown in figure 2.4. Therefore, the flange must be at least equal to twice the board manufacturer's recommended edge distance plus the recommended gap between boards (to allow for board expansion).

As flange sizes may vary it is important that the proposed board manufacturers are consulted during the design process to ensure that edge fixing tolerances are accommodated.

Figure 2.4 Minimum flange width for fixing board to C section flange

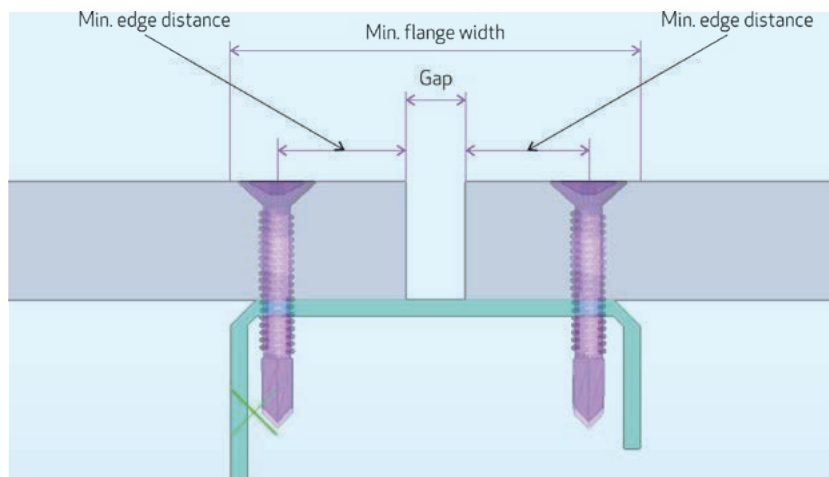

3 STRUCTURAL DESIGN

This section presents guidance on structural design issues that are specific to light steel external walling. Generic structural design guidance for light steel sections is provided in SCI publications **P276** ¹ and **ED005** ².

3.1 Loads

The predominant load acting on external walls is wind loading. However, the weight of the wall system and the cladding that it supports must also be considered in the design, especially for lintel sections.

Wind loads

Wind loads are assumed to act perpendicular to the plane of the external wall panels. The wind loads will cause bending moments in all the elements of the panel, and the panel must be designed to resist these bending moments.

Wind loads should be calculated in accordance with an appropriate standard, either:

- **BS 6399 2: 1997, Loading for Buildings. Code of practice for wind loads** ⁷ (withdrawn, replaced by below)
- **BS EN 1991-1-4, Eurocode 1, Part 1 4 Wind Actions (BS EN 1991-1-4: 2005 +A1: 2010)** ⁸

Wind loads are sensitive to geographic location and site-specific factors; these factors must be included in the application of the wind loading standards given above.

Wind loads can result in positive or negative (suction) pressures; both types should be considered in the design process.

Typically, in design, wind loads on external wall systems are assumed to be uniformly distributed. This assumption is only valid where the cladding system is fixed to each vertical C section; this may not be the case with all cladding systems.

Wind pressures will vary for different parts of the buildings. Generally, wind pressures at the corners of buildings will be about 30% higher than in zones near the centre of an elevation.

The calculation of wind loads on external wall panels should consider internal and external wind pressure coefficients. Positive and negative internal pressures should be

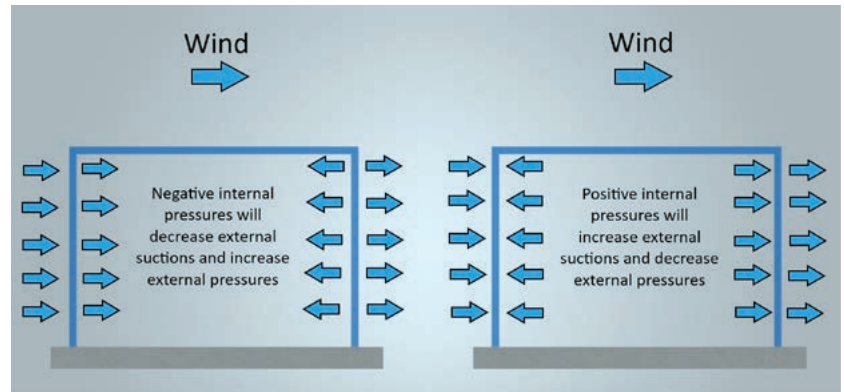

Figure 3.1 Internal wind pressures acting on the façade walls

considered. (A negative internal pressure will increase the effect of positive external pressures and a positive internal pressure will increase the effect of external suction – see figure 3.1.)

Further guidance on wind loading on buildings is given in SCI publications **Guide to evaluating design wind loads to BS 6399-2: 1997 P286** ⁹ and **Wind Actions to BS EN 1991-1-4 P394** ¹⁰.

If there are openings and opening windows in the façade this will result in different pressures on the façade these will be impacted by the effect of vortex and also shedding vortex.

This is described in the image above and **BRE Digest 346** ¹¹ provides more information when calculating load.

Dead loads

The dead load is the weight of the external wall system and the cladding system that it supports. Dead load will cause axial compression in the vertical elements of the panel (ie studs and jambs). A lintel is required to support the wall panel above an opening and thus the dead load will cause a bending moment in the lintel. Due to the combined effect of wind load and dead load, the lintel will be subjected to biaxial bending.

Light steel external walls can be used to support light-weight cladding systems.

Heavy cladding, such as brickwork, cannot be supported by external wall systems but they can be used to provide lateral support via brick ties connected to the vertical C sections.

Traditionally, axial forces in the studs caused by the weight of the wall and components attached to it are ignored in

⁷ <https://shop.bsigroup.com/ProductDetail/?pid=00000000030040684>

⁸ <https://shop.bsigroup.com/ProductDetail/?pid=00000000030206733>

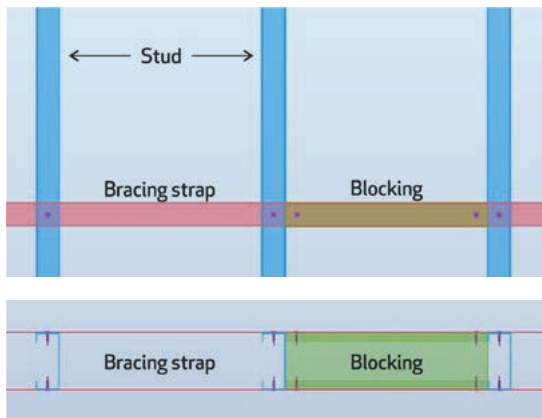

Figure 3.2 Typical 'blocking and bracing'

design because they are considered small in comparison to the effect of the wind load. However, axial compression in stud sections will reduce their bending resistance. Therefore, it is recommended that dead load may only be ignored when both of the following limits are met:

- Panel height not more than 5m
- Load due to self-weight of the façade not more than 1.5kN/m²

The designer must consider the local effects and eccentricity of cladding loads (see section 3.3).

3.2 Design resistance

Limit states

The elements of light steel external wall panels should be designed for two limit states:

- Ultimate Limit State (ULS)
- Serviceability Limit State (SLS).

ULS is concerned with the structural safety and the strength of the panel and its elements. Resistances are required to be not less than the effects of design loads (characteristic loads multiplied by load factors).

SLS is concerned with the 'fitness for use', including deflections of the panel and its elements. Deflections due to (unfactored) SLS loads are required to be within specified limits.

Members subject to bending

Members subject to bending must be designed to ensure they have sufficient bending resistance and resistance to member buckling,

where restraint is not provided to both sides.

Attachment of members to boards will provide restraint and increase the member's buckling resistance. However, the contribution of board restraint should be ignored in design unless there is supporting test data to confirm the level of restraint that is provided. The level of restraint provided by boards will depend on many factors, including the board properties and how it is fixed to the light steel elements.

For light steel external walls, 'blocking and bracing' can be used to provide lateral restraint to members for the purpose of increasing the member's buckling resistance. 'Blocking and bracing' consists of steel bracing straps fixed horizontally across the panels with blocking pieces or 'noggins' (cut from C section) fixed between studs (usually every third bay and at ends). Blocking and bracing is shown in figure 3.2.

'Blocking and bracing' is normally provided on walls greater than 3.6m high, or as determined by structural calculations. It may not be required where sheathing board is positively fixed on the external face and gypsum based board is positively fixed on the internal face.

Effective length (buckling length)

Buckling resistance of members is partly dependant on their effective length (termed buckling length in Eurocode design). The effective length is equal to the actual length multiplied by a factor which is dependent on the restraint provided by the connections at the ends of the member and the restraint along the length of the member.

An effective length factor for bending of 0.85 may be used for vertical studs when the following conditions are met:

- Additional restraint provided by boards attached to studs is not included elsewhere in the stud design
- Moment variation along the member is not considered in the design of the member.

Connection to columns

Generally, it is not necessary to connect the vertical members at the end of each infill wall panel to the columns of the primary

Figure 3.3 Illustration of cladding load eccentricity

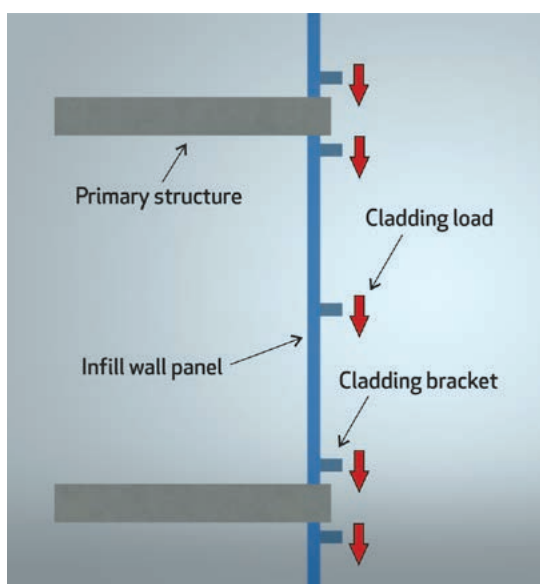

frame, as they are designed to span vertically between floors. Where bracing straps are used to provide lateral restraint to the studs, it is necessary that the bracing strap is connected to the primary columns to ensure lateral restraint. Where the infill wall panel is connected to the primary columns, it is not necessary to use slotted connections to allow differential movement between the infill wall panel and primary column.

The design of the primary frame column is unaffected by the requirement to provide lateral restraint to members in the infill wall panel because the lateral forces are generally insignificant compared to the primary frame design loads.

3.3 Cladding loads

Cladding may be attached to the external wall panel via cladding brackets. The cladding brackets will pass through the external insulation and support the cladding eccentrically ie load imposed on a structural member at some point other than the centre of the section to the wall panel, as shown in figure 3.3.

Thicker insulation means a larger eccentricity between the cladding and the light steel wall panel.

The structural design of the connection between the cladding bracket and the light

steel wall panel must consider the pull-out of fixings, local deformation of the light steel sections and the eccentricity of load.

3.4 Deflections

The principal property of a light steel section for limiting deflections is its stiffness, which is a function of its second moment of area. The second moment of area used to calculate the stiffness of a section is less than the gross second moment of area, due to the effects of local buckling of the thin steel elements in compression.

The second moment of area used for deflection calculations is somewhere between the second moment of area for the full gross section and that of the effective section in bending.

For design to BS 5950-5 (see **Building Design Using Cold Formed Steel Sections P125 12** and **P276 1**) the second moment of area that may be used for deflection calculations (I_{SLS}) should be taken as:

$$I_{SLS} = (I_{Gross} + I_{Eff}) / 2$$

Where I_{Gross} is the second moment of area for the full gross section and I_{Eff} is the second moment of area for the effective section in bending including effects of local buckling.

For design to BS EN 1993-1-3 (see **ED005 2**) the second moment of area that may be used for deflection calculations (I_{SLS}) should be taken as:

$$I_{SLS} = I_{Gross} - ((I_{Gross} - I_{Eff}) / 1.5)$$

For deflection calculations, the members of infill wall panels should be assumed to be nominally pin-ended.

Deflection limits

Deflection limits under (unfactored) wind load may be taken as:

- L/500 for brickwork (ignoring the stiffening effect of the brickwork)
- L/360 for brickwork (including the combined stiffening effect of the brickwork)
- L/250 for lightweight cladding (eg insulated render, rainscreen and metallic panels)

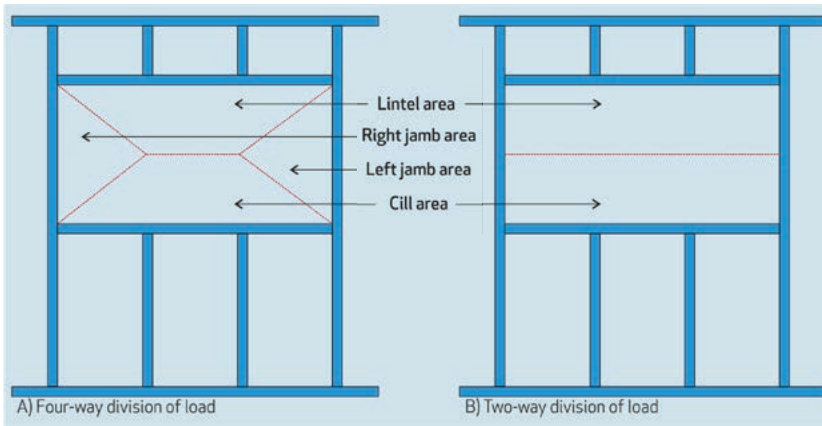

Figure 3.4 Division of opening area into loading on the members

- L/250 limit for plasterboard
- L/360 limit for brittle finishes
- L/360 for glazing along the length of window openings
- Absolute deflection of members above or below an opening is recommended as 15mm if this is less than span/360 (ie for spans greater than 5.4m).

3.5 Openings

Openings in external wall panels are required at window and door locations. Additional members are required to frame around openings: jambs either side of the opening; a lintel above the opening; and a cill below the opening (as shown in figure 2.2).

Figure 3.5 Typical single, boxed, and compound sections

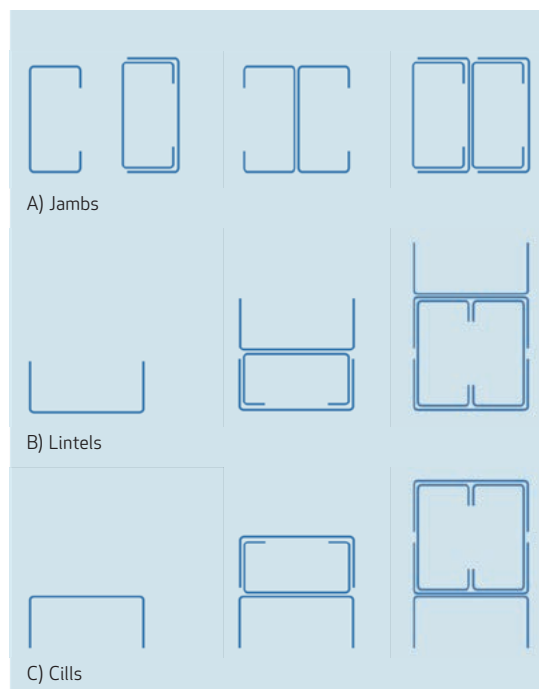

Figure 3.6 Infill walling around primary bracing



The elements around the opening must be designed to resist the effects of the wind load that would be applied to the area of the opening. The area of the opening should be divided between the adjacent elements; one approach for dividing the area is shown in figure 3.4a. Alternatively, for simplicity, the window may be assumed to span vertically between the lintel and the cill, as shown in figure 3.4b. The loads are then transferred as point loads applied to the jambs either side of the opening.

In many cases the framing members will consist of several sections forming one compound section. Typical compound sections are shown in figure 3.5.

Some general guidance on the use of compound sections around openings is given below. However, this is not intended to replace structural design for sections around openings because project-specific conditions will be significant in the selection of a suitable solution.

- For windows up to 1.5m width, it may be expected that single sections are used vertically and horizontally (ie for lintels, cills and jambs)
- For windows up to 2.4m width, it may be expected that compound sections are used vertically (jambs) and single sections are used horizontally (cills and lintels)
- For windows up to 3m width, it may be expected that compound sections are used horizontally and vertically (lintels, cills and jambs)
- Alternatively, for wide windows, compound sections as illustrated in figure 3.5, or wind posts may be utilised (see section 9.1).

3.6 Detailing around primary frame bracing

Special detailing may be required around primary frame bracing, as shown in the example in figure 3.6. Triangular shaped panels can be installed using the same sections as used for rectangular panels. The infill wall panels must be detailed such that the loads can be resisted and that deflections in the primary structure do not cause additional loads in the members of the light steel infill wall system.

3.7 Holes in members

Light steel members can be delivered to site with pre-punched holes for services.

When the following recommendations are observed, holes in the webs of sections primarily subjected to bending, have negligible influence on the structural performance of the member.

- The maximum width of an unstiffened rectangular hole or slot in a light steel member should not exceed 40% of the overall width of the section. The length of the hole should be less than three times the width of the hole
- The diameter of circular holes should not exceed 60% of the depth of the section
- Holes should be positioned on the centreline of the section
- Unstiffened holes should be at least the depth of the section apart and should be at least 1.5 times the depth of the section away from the end of the member
- All holes should be formed by punching.

Larger openings in the steel sections may require reinforcing by the addition of steel plate attached to the web around the opening or by creating an opening with a swaged (lipped) edge (see figure 3.7).

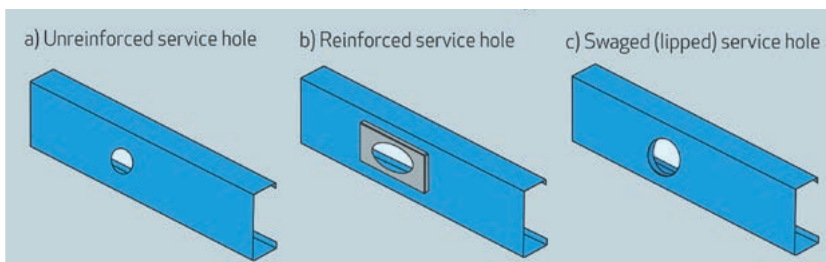

Figure 3.7 Service holes in steel studs

Any holes in webs either factory prepared or site cut subject to design considerations and full approval of the system provider, must be taken into account when carrying out structural calculations.

Cutting holes in the light steel webs on site is not recommended but, where necessary, holes should be formed with specialist tools to minimise the risk of leaving rough edges and causing damage to the galvanized surface. Advice from the manufacturer or qualified structural engineer must be obtained before cutting any holes or notches in sections.

The steel sections should never be cut by flame-cutting because it will impact the strength of the steel.

Notches should not be formed without confirmation that the structural adequacy of the member is maintained; the engineer or designer responsible for the element should provide the confirmation.

3.8 Splices

In some situations, it may be necessary to join light steel sections together with a splice connection. The adequacy of splice connections should be confirmed by structural calculations. In continuous external wall systems, studs are commonly spliced into manageable lengths to facilitate safe site installation, see section 8.2.

Wherever possible, members of the infill walling system should be formed from full lengths of section. Off-cuts of sections should never be joined together to form lengths of sections.

3.9 Load tables

Manufacturers of light steel external wall systems will be able to provide system-specific load/span tables or design software that takes into account:

- Height of wall
- Wind load
- Opening size.

4 SETTING OUT, TOLERANCES AND MOVEMENT

4.1 Setting out

Support length

The minimum length bearing width of support under sections is two-thirds of the section width or 80mm for sections less than 120mm wide. The maximum projection over the slab edge is given in figure 4.1.

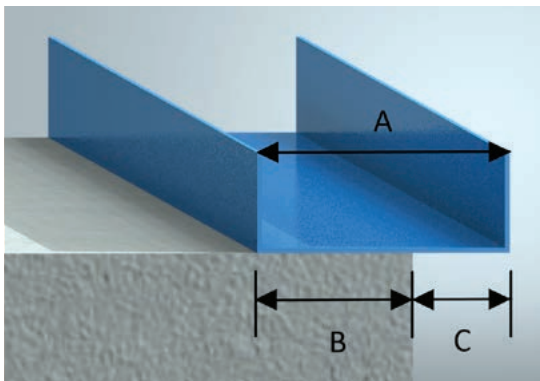

Figure 4.1 Minimum length bearing width

A (mm)	B (mm)	C (mm)
100	80	20
120	80	40
150	100	50
180	120	60
200	133	67
220	147	73
250	167	83

4.2 Installation tolerances

Installation tolerances should be agreed with the main contractor at the start of the project.

The National Structural Steel Specification (NSSS) 13 is written for primary structural steel frames but it may be used for guidance.

As a minimum requirement the sections used for light steel external walling should comply with the requirements of **BS EN 10162: 2003 Cold rolled steel sections – Technical delivery conditions – Dimensions and cross-sectional tolerances 14**.

Members for light steel infill wall systems are typically cut to length on site so that deviations in the primary structural frame can be accommodated. Typical guidance for infill wall installation tolerance is given below:

- Tolerances in straightness of wall = $\pm 5\text{mm}$ in 3m length. This also depends on the type of cladding

- Out of verticality (plumb) of wall = $\pm 5\text{mm}$ in 3m height (H) or $H/600$ for walls over 3m in height
- Acceptable deviation in level of slab or beam soffit = $\pm 10\text{mm}$ over 3m length
- Tolerance in length of C section = $\pm 5\text{mm}$ in 3m length (positive deviation could compromise movement at head detail)
- Tolerances for position of base track = $\pm 10\text{mm}$ from intended centre line
- For fixing details of C sections to the base track, refer to system manufacturer's technical manual
- For tolerance on noggin length, refer to system manufacturer's technical manual.

4.3 Openings for windows and doors

The structural opening size is taken as typically 10mm wider and deeper than the actual window or door dimensions; this must be reviewed with the window and door manufacturers. This is to allow for deviations and for the thickness of the connecting plates to support the windows. In some situations, it may be necessary to increase the 10mm allowance to 15mm if the thickness of the fixing plate exceeds 3mm.

Structural opening sizes or actual door or window dimensions must be clearly specified on the drawings.

“Boards should not be screwed to the head track, to avoid compromising the free movement relative to the structure.”

13 <https://www.ridba.org.uk/2017/06/27/national-structural-steelwork-specification-building-construction/>

14 <https://shop.bsigroup.com/ProductDetail/?pid=00000000030016643>

4.4 Deflection head detail

To allow the floors of the primary structural frame to deflect during service without inducing axial loads into the infill wall, the head track must incorporate a deflection head detail.

The deflection head detail is required to restrain the vertical members against horizontal movement but to allow the head track to move vertically, independently of the studs. Various deflection head details are used in practice. Some examples are shown in figure 4.2.

The required deflection head allowance should be specified by the designer of the supporting primary frame. Typical values for deflection allowance are given in table 4.1. The clear space between the top of the studs and the web of the head track after installation should be at least equal to the appropriate value from table 4.1.

Boards should not be screwed to the head track, to avoid compromising the free movement relative to the structure.

Edge beam span (m)	Deflection allowance (mm)		
	Steel framed building	Renovation of existing concrete framed building	New build in-situ or precast concrete framed building
4	±10	±10	±16
5	±10	±13	±20
6	±12	±15	±24
7	±14	±18	±28
8	±16	±20	±32

Note: the higher deflection allowance for new build concrete buildings is to take account of the long term creep and shrinkage effects of the concrete.

Table 4.1 Typical deflection allowances

Figure 4.2 Typical deflection head details

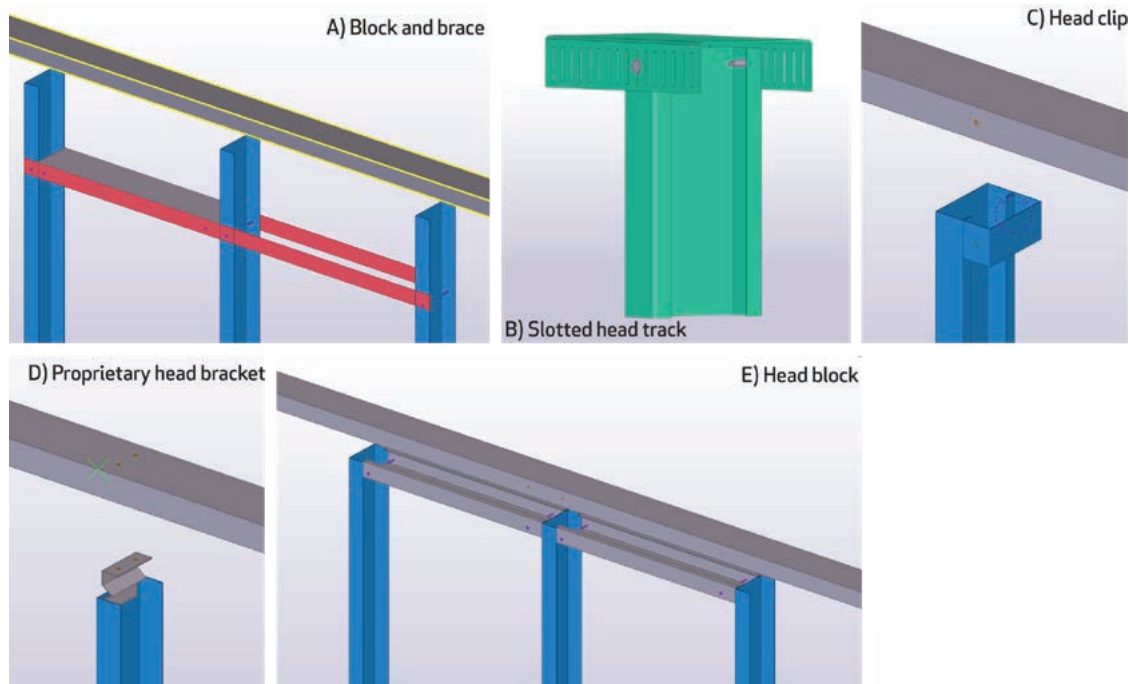

5 FIXING DETAILS AND FASTENERS

5.1 Fixing details

Generally, members for infill walling are cut to length on-site. Therefore, connections are generally formed on site without the use of pre-drilled holes or pre-marked fastener positions. System suppliers will have standard construction details which should be followed.

Fixing details should generally comply with the following recommendations.

Fixing between members of infill wall panels

- For connection between light steel members where a 'flush' finish is required, use pan head 5.5mm diameter screws (to outer threads) or 4.2mm (shank diameter). Screws have a 2mm projecting head.
- For connection between light steel members where a 'flush' finish is not required, use hex head 5.5mm diameter screws (to outer threads) or 4.2mm (shank diameter).
- The minimum edge distance for a screw fixing into a light steel section should be three times the fixing diameter (to outer threads) and not less than 10mm.
- Fixings between the base track and

the studs are required from both sides of the wall panel.

- Do not use drylining screws for steel connections.
- Fixings should be galvanized.
- Fixings should have a European Technical Approval or an equivalent independent technical assessment.
- Fixing centres for compounding to be calculated by the engineer designing the light steel members.

Fixing between infill wall panels and primary structural frame

- For connection of tracks to the concrete slab or soffit, use 6mm diameter concrete screws, with 5mm diameter hole in the concrete.
- For connection of tracks to the steel beams, use 5.5mm self-fixing self-drilling (SFSD) screws or 3.2mm diameter powder actuated fixings.
- Spacing of fasteners should not exceed 600mm.
- Additional fixings will be required at track ends and split points; within 100mm of the track ends.
- The fixing manufacturer's advice should be sought for the use of shot-fired nails into concrete without pre-drilling the concrete.
- For acoustically sensitive

applications, place an acoustic tape on the slab surface prior to location of the bottom track.

- For a ground floor slab, use a damp proof course (DPC) below the bottom 'track'.
- The distance from the edge of the slab to the fixing and the distance between fixings should meet the manufacturers guidance and recommendations.



Fixing between infill wall panels and board materials

- Board manufacturers' literature should be consulted to confirm recommended fixing details and minimum edge distances.
- The use of gas-applied fixings is not recommended.

5.2 Types of fastener

Typical types of fastener used in light steel infill walling systems are presented in table 5.1. For all types of fastener, the manufacturer's installation instructions should be followed.

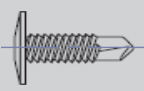
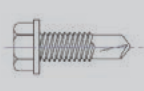
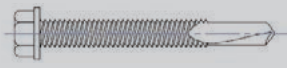
Table 5.1 Typical fasteners

Fixing name	Description and application	
Pan head SDST screw	Typically 5.5mm diameter. Self-fixing self-drilling (SFSD). Used to connect light steel sections together where a flush finish is required.	
Hex head SDST screw	Typically 5.5mm diameter. self-fixing self-drilling (SFSD). Used to connect light steel sections together where a flush finish is not required.	
Concrete screw	Typically 6mm diameter and greater. Used to connect light steel sections to concrete.	
Hot rolled fine thread screw	Typically 5.5mm diameter. Used to connect light steel sections to hot-rolled steel.	
Shot-fired nail	Powder-actuated nail fixing. Used to connect light steel sections to hot-rolled steel.	

6 INSTALLATION

Light steel external wall systems should be installed by companies approved as installers by the external wall system supplier. The installers will generally be working as subcontractors to the main contractor, who is responsible for the construction of the building.

6.1 Site preparation

Structural level checks

Before commencing installation, drawings should be checked for approved status, if the drawings are not passed off by the project architects (A status) then the installer carries the risk that remedial works or changes may be required (at his expense) after the light steel external wall system has been installed.

The working area should be checked to ensure that there is clear access to the workface and that the as-built structural bay dimensions are within tolerance of the drawn dimensions. The quality and integrity of the substrate should be checked and the alignment of the structural elements assessed to ensure that the light steel infill walling can be put in with the requisite bearing on the substrate. Checks should be carried out to ensure that there is nothing to impede fitting the infill walling.

If there are any issues, the main contractor should be notified before commencing installation.

Gridline set out

The main contractor's site engineer will be responsible for providing gridlines across the slab that will directly relate to the elevation drawings. These grids will be sprayed on marks at regular intervals that can be connected using string lines and spray paint. The grids will not necessarily be on the drawn position but may be off-set by a nominated dimension (usually 1 metre). This is done to avoid obstacles or to avoid being masked as the steel is placed on the external edge. The position of the infill walling can then be identified, as it sits to the edge of the structure, using measurements from the centre of a structural opening (dimensioned to the edge of the jamb) within the bay to align to grid.



Figure 6.1 Fixing of base track to concrete slab

The installer will set-out the rear or the front of the infill walling on the floor slab, in accordance with the drawing, and will create a chalk line along the edge. Using a laser, the installer will then transfer the line onto the structural soffit. These lines will show the intended positions for base track and head track.

6.2 Basic installation principles

Cutting members to length

Where members are cut to length on site, it is advisable to set up a cutting area and identify it as a Hearing Protection Zone. Proper setup of a work bench to site the metal cutting equipment and to support the individual sections will help to avoid accidents and manual handling risks. The base and head tracks can be cut using the metal cutting equipment to the required bay width. Checks may be needed to ensure that track is not fitted across the base of a doorway section, unless shown on the drawings; the contractor should be able to confirm this.

Head and base tracks

Tracks are normally supplied in 3 or 4m lengths. As noted in section 2.2 the base track and head track may differ in gauge, this will be noted in the project drawing.

The base track should be aligned to the setting out lines and then fixed to the substrate using the specified fixings at the required centres. Care should be taken to ensure that the track does not move out of place as the initial fixings are drilled through the member. In some cases, the member may need to be pre-drilled with a high speed steel drill before fixing. Fixing of base track is shown in figure 6.1.

The head track can be fitted using the same methodology. However, the alignment of the two tracks (one above the other) should be checked using a length of stud cut to size and a spirit level. This will ensure that the wall will not lean out of plumb. Final fixing should only occur after these checks, or time and cost will be incurred if either track has to be repositioned.

Ensure that the specified fixings at the track ends and split points are provided; generally, this will require double the amount of fixings at these points, and within 100mm of the track edges. Check that there is sufficient bearing on the substrate at both the base and the head of the panel; there will be a specific dimension for each situation on site. As a general rule, the bottom track of the light steel infill walling can overhang the edge of the structure by up to one third of its width (see section 4.1). Check that acoustic tape and DPC is installed under base track where specified.

General stud installation

Initial stud positions should be measured from the grid using a tape measure and should be determined from the centre of a structural opening. If there are no openings within the bay, then the elevation drawing will usually specify the position of the first stud and provide stud spacing requirements across the rest of the bay.

The bay height should be checked, and the studs cut to size, with appropriate allowance for deflection and the head track web (see section 4.4).

The studs should be placed into position and fixed as specified through the base track. Ensure that jamb studs are oriented so that

the webs of the studs are providing the sides of the structural opening. The fixings must be installed before any boards or finishes cover the studs.

The simplest method of stud installation is to set out the studs at the edge of the structural opening, then measure off the required centres of the rest of the studs within the bay (generally 600mm), or use a block cut to size as a template. However, attention should be paid to the installation of the internal boarding that may require the studs to be set out from specific grids from one end of an elevation to the other.

Setting out openings

The jamb studs either side of an opening should be set to provide the width of the structural opening and to provide a surface to fix the door or window frame.

The contractor's engineer is responsible for putting horizontal datum lines on the structural columns. These marks will have an offset to the structural slab, usually this is 1m from structural slab level (SSL), but must be clarified before proceeding. The position of the cill can be marked on the column before transferring the mark across the studs to the relevant structural opening. On occasion the datum mark will be given offset to finished floor level (FFL). Care must be taken to consider the possibility of screed sitting on the structural slab.

Cill construction will consist of studs fitted to the jamb studs. These will be the full length between base track and cill height. The cill member will then fit above these studs, fixed at each end and to the studs in the zone under the cill (according to the stud centres in the bay).

The lintel position can then be ascertained from the cill using the opening dimension shown on the drawings. The lintel is fitted in much the same way as the cill. The lengths of stud above the lintel should include the same method of accommodating deflection as the general studs.

The installer must make provision for any compound members required for the jambs, cills and lintels (see section 3.5).

7 HEALTH AND SAFETY

Most of the health and safety considerations related to the installation of light steel external wall systems are common to many construction activities. Therefore, much of the information presented in this section will have wider application beyond that of light steel external wall systems.

This section is not intended to be comprehensive, only those aspects of health and safety which have particular relevance to the installation of light steel external wall systems are included.

7.1 Edge protection

Edge protection is particularly relevant to the installation of external wall systems due to their location within a building.

Under no circumstances should persons be exposed to working at height without suitable control measures in place.

When there is no scaffold present at the edge of the slab the main contractor will have installed some form of edge protection. A common method of protecting the exposed edges of a building is to fix a fencing frame to the structure; attached to posts fixed into the structural slab, to the face of the structure or fixed to the soffit of the floor below. As the external wall installation progresses the edge protection will be removed. The external wall will provide a satisfactory barrier to falls from the building once completed. However, this may lead to areas above or below the works having an exposed edge; other forms of barrier will then be needed. At the exposed edge, operatives will need to be harnessed to the structure to prevent the possibility of a fall. The method of edge protection will depend on the type of access equipment used (see section 7.6). Possible types of edge protection include:

- Temporary or permanent barriers
- Scaffolding
- Netting
- Harness / lanyard – only when the options above are not possible.

There may be areas around stairs and lifts that require special protection as they are more heavily trafficked. These areas should be identified.

“Under no circumstances should persons be exposed to working at height without suitable control measures in place.”

Installation of parapets, ribbon windows and walls at balconies or patios may require special safety procedures.

7.2 Manual handling

Light steel external walling is constructed from lightweight components; therefore, manual handling is undemanding in comparison to alternative solutions.

In the case of compound sections assembled and fixed on the floor, the total weight of the assembly will require consideration as to safe handling during erection.

For all sites, a specific plan and risk assessment should be developed by the installer that will evaluate the risks attached with handling light steel sections and equipment.

Manual Handling at Work – A Brief Guide 15 is available from the HSE on reducing the risk of manual handling injuries.

Continuous (oversail) walling systems also require consideration as to the appropriate method for safe handling during erection because longer stud lengths are heavier and have a high level of flex due to their slenderness.

General guidelines in management of manual handling are:

- Workers should receive training in kinetic lifting
- Plan material use and adopt good practice when stacking materials
- Use mechanical lifting equipment where practicable
- Use team lifting for awkward and heavy loads
- Good housekeeping standards should be maintained in all work areas
- All spillages or general rubbish should be cleared in a timely fashion.

7.3 Cutting

Procedures for cutting of light steel sections should be defined and safety procedures followed. Operatives should hold a current 'Abrasive Wheel' certificate for on-site cutting. Normal handling precautions for cut edges should be observed.

Care must be taken to ensure that guards and handles are properly fitted to tools and that there are plenty of blades available on the cutting disc, operatives must use the specified personal protection equipment (PPE) according to the manufacturer's specification. 'Hot works' permits may be required on some sites, as well as the use of baffles or spark boxes.

7.4 Method statements

The method statement is the installer's interpretation of how the installation is actually going to be carried out. Usually the method statement is a simple, brief document that demonstrates competence to the main contractor and is a guide to the individual operatives, who should all read, sign and date the document to signify their understanding and acceptance. It should also form part of a checklist/handover document that the main contractor can use to check that the installation has been carried out correctly.

7.5 Risk assessments

Risk assessments for the project should be carried out before the installation of the light steel external walling system. Risk assessments should consider general hazards as well as any site-specific risks. Any actions to reduce risk that are identified should be carried out and documented before site works commence.

All operatives involved on site should read and understand the information within the risk assessments. The site operatives should then sign and date their acceptance of these documents. The risk assessment system should be backed up with a series of health and safety toolbox talks about a specific site related issue or a general health and safety concern.

7.6 Access equipment

Various types of access equipment can be used for the installation of light steel external wall systems. Some of the common methods are given below with brief descriptions of issues that need to be considered before selection.

"All operatives involved on site should read and understand the information within the risk assessments. The site operatives should then sign and date their acceptance of these documents."

Scaffolding

Scaffolding is a series of steel poles and wooden planks, designed with calculation, to provide platforms that can be worked off. Scaffolding is generally set with 2m working heights along the outside of the elevations and is nearly always used on tall structures and when the footprint of the site allows.

Scaffolding is expensive, and its use requires careful planning and coordination with other trades. There can be problems with tying into the building through the external wall that can prevent completion of works at the first visit. When set up correctly, scaffold provides good access to the outside of the wall and good storage of materials, however other trades may also use scaffold, which can create obstacles to progress of external walling installation.

Dependant on finishes and external wall build-up, there is a potential for unsafe working conditions due to gaps between the scaffold edge and the wall, individuals often pull back boards making work areas unsafe. Therefore, careful coordination with scaffolding contractors is necessary. Scaffold can provide excellent defence against damage to the wall; it can be sheeted and canopied to provide a barrier to wind, rain and general poor weather conditions.

Scissor lifts

Scissor lifts are moving platforms that have a flat platform on which to work. They are often diesel fuelled extendable platforms that can reach out to over 18m. They are considered a cheaper alternative to scaffolding, but care must be exercised to avoid using scissor lifts where it is inappropriate or dangerous (eg where ground conditions are uneven).

Operators working from scissor lifts need to be qualified. Untrained operators may cause accidents and damage. Ground conditions are crucial – often where landscaping is required the contractor does not want to pay to put down hard standing materials. Combined with poor weather this can cause the ground to turn muddy with forklifts and scissor lifts churning up the ground, getting stuck and causing delay.

Scissor lifts are generally slow to manoeuvre, lift and drop. Deviations in the ground can prevent the lift going up and the lift height is limited. There are often difficulties with fuelling up, flat batteries and flat tyres causing delays on site.

With scissor lifts there are often delays getting to the point of work in comparison with scaffold. Scissor lifts do not provide any protection to the workface or the workers located on the building.

Cherry picker

A cherry picker is a small basket on an extendable arm that is fixed to a movable base (diesel powered); it is not suitable for general light steel infill walling installation but can be used for small remedial works or the installation of continuous walling brackets to a slab face (see section 8). Operatives will need specific training and will be required to wear harnesses.

Mast climber

A mast climber can have a platform width of up to 20m. They are generally pushed and fixed into place through the external wall. They have limited mobility and are fairly slow to lift and lower. They do not provide any protection to the workers or working edge.

Access from floor slab

When working off the floor slab it will usually be necessary to use some form of equipment to allow access to the top of the external wall panel at the soffit of the floor slab above.

A hop-up including all safety rails is an individual platform that provides a base of up to 1m². More than one hop-up may be required when handling long lengths of steel.

A mobile tower is a clip-together scaffolding tower that provides a base at a level that is adjusted to the height required. A mobile tower will have a larger size platform than a hop-up. However, this can lead to accidents because tools and materials stored on the platform can cause trip hazards. Mobile towers must be erected and signed off by a competent person.

Stepladders are not allowed on most sites as there is an increased risk of accidents due to falls.

“Scissor lifts do not provide any protection to the workface or the workers located on the building.”

8 CONTINUOUS WALLING

Continuous walling (also known as oversail walling) is placed externally to the primary structure. The components used in continuous walling are similar to those used for infill walling. However, there are some significant differences that must be considered in design and construction. The main differences are the connection of the walling system to the primary structure and the longer length of the vertical studs as they can be continuous over several storeys.

8.1 Connection to structure

For continuous walling, the self-weight of the external facade is generally supported by an angle section fixed to the primary frame (see figure 8.1). In order to avoid excessive compression forces on the lower studs, it is recommended that these dead load support brackets are installed at least every four floors. Brackets connecting the continuous walling studs to the primary frame at the other floors only provide lateral restraint to the studs and must have slotted holes to allow for relative movement of the supporting structure, see figure 8.2 and note the four screw connections to the stud bottoms and the slotted connection to the tops of the lower studs. Typical deflection allowances are given in table 4.1.

8.2 Splices

Studs should be spliced into manageable lengths to facilitate safe site installation. Splices are generally located just above restraints at floor levels and should be individually designed to ensure that they are adequate for each application.

8.3 Openings for doors and windows

Openings for doors and windows are formed using the same methods as used for infill walling systems (see section 3.5). However, due to the larger loads in jambs, lintels and cills, the support brackets for these members may need to be fabricated from thicker steel compared to the general stud brackets. The thickness and dimensions of all brackets must be verified by project-specific structural calculations.

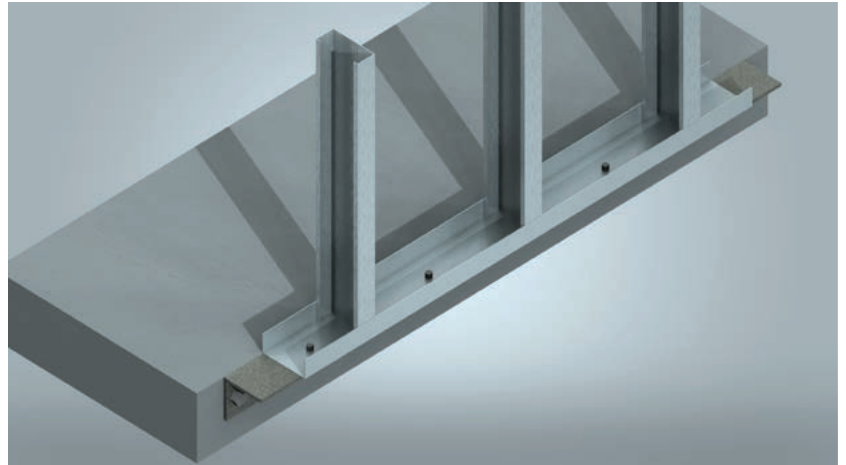

Figure 8.1 Angle bracket for support of continuous walling

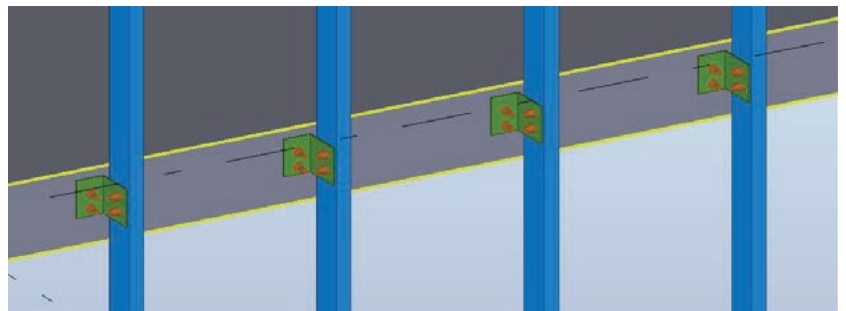

Figure 8.2 Bracket support for continuous walling

“The components used in continuous walling are similar to those used for infill walling. However, there are some significant differences that must be considered in design and construction.”

9 SECONDARY STEELWORK

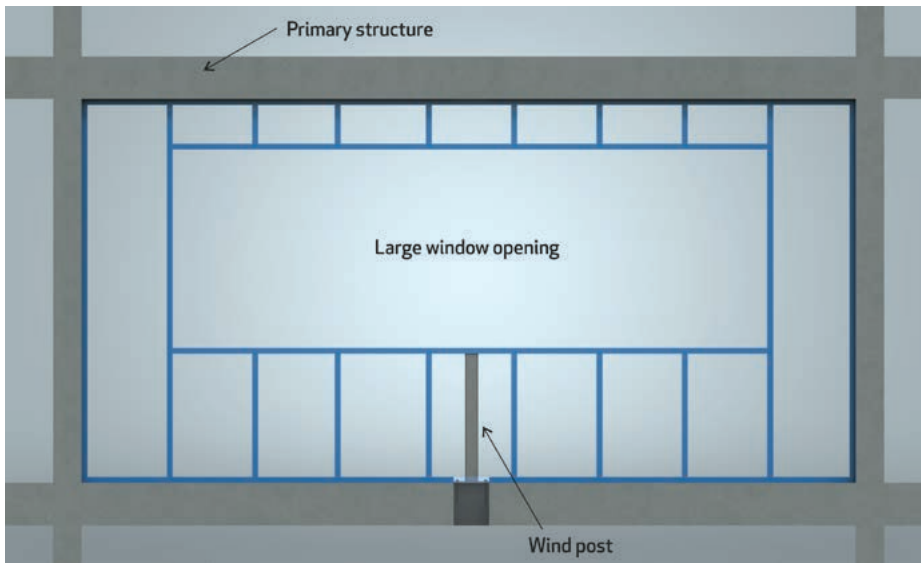

Figure 9.1 Typical wind post detail below a large window

9.1 Wind posts

Wind posts are items of secondary steelwork that are used where it is necessary to provide additional horizontally spaced structural support to the light steel walling system. Wind posts typically use structural hollow sections or parallel flange channels with welded base plates that are designed to be located within the depth of the infill wall. Wind posts commonly cantilever from the floor slab and must be designed to resist the overturning moment due to the wind load on the wall panel. Wind posts are typically used at large openings, ribbon windows and parapets. A typical wind post detail used below a large window is shown in figure 9.1.

The preferred method of fixing wind posts to the primary slab is by 8mm or 10mm diameter chemical anchors or expanding anchors.

The distance from the edge of the slab to a concrete screw should meet the manufacturers guidance and recommendations. The embedment of chemical anchors should generally be a minimum of 80mm or 100mm,

for 8mm or 10mm diameter anchors respectively. In all cases, anchors should be installed in accordance with the manufacturer's recommendations.

Generally, a minimum of four anchors should be used to connect the base of the wind post to the primary structure.



Figure 9.2 Z bar support brackets to infill walls along the line of the edge beam

There are practical problems associated with installing wind posts in reinforced and particularly pre-stressed or pretensioned concrete slabs or up-stands, especially if there are constraints on the width of the base plates. Bolt locations should be set out prior to the slab being cast, to identify any clashes and bolts cast into the slab in preference to holes being drilled into the cast slab for fixings.

9.2 Projection brackets

If an infill wall is required to project over the slab edge, special brackets are required to support the wall (as shown in figure 9.2). The wall support brackets are anchored to the slab using a minimum of two fixings (see section 5.2).

9.3 Projection of windows

Where windows project outside the line of the infill wall, galvanized steel plates of 2mm or 3mm thickness and normally of 200mm to 400mm width may be screwed to the cill every metre (or a minimum of two per window). The solution adopted should be subject to design by the project engineer for the proposed windows and required projection from the infill wall panel.

The number of fixings from the support bracket to the cill must be calculated by the structural engineer designing the light steel members.

The design and specification of these support plates and their fixing to the infill walls must consider the self-weight of the window (typically 50kg/m²).

It is recommended that the eccentricity (a load imposed on a structural member at some point other than the centroid of the section) of the centre line of the window from the centre line of the wall should not exceed 200mm. The support plate should project over the complete depth of the infill wall, as shown in figure 9.3, with a fixing not more than 25mm from the inner face of the wall panel.

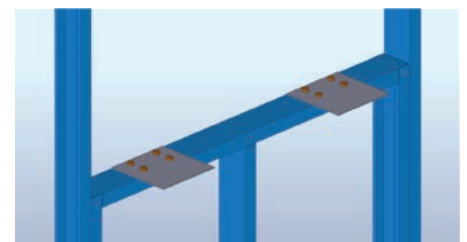

Figure 9.3 Projecting window support brackets fixed to cill

10 SPECIAL CASES

Where special arrangements are needed, it is important that advice is sought from both the project engineer and from the walling manufacturer.

There are many situations within buildings using light steel external walling where special arrangements are needed, these include:

- Parapets
- Curved walls
- Ribbon windows
- Inclined walls
- Balconies
- Application below DPC/lower than a minimum of 75mm above finished external ground level
- Up-stands and down-stands
- Fitting of infill walls around bracing
- Support for very heavy cladding.



Figure 10.2 Large ribbon window in infill panel



Figure 10.1 Curved infill walling - during and after construction



Figure 10.3 Light steel external walls with integrated balconies

11 CHECKLISTS

This section provides a series of checklists for people involved in the design and installation of light steel external walling.

11.1 Checklist for external wall designers and specifiers

The designers and specifiers of the external walling should check the following:

Structural design

- Have site-specific loads been provided or calculated (eg wind loads)?
- Have all special connection details been specified?
- Have all fixing types, including spacing and edge distances, been specified?
- Has an erection method statement been provided which clearly shows any special requirements for access?
- Is the specification of steel and coating suitable for the relevant environment category class?

Interfaces

- Are all interface details clearly shown on the drawings and are special requirements such as isolating gaskets clearly identified?
- Where unfamiliar materials are specified, has advice been sought from specialists and have any special requirements been noted on the drawings?

Installation drawings

- Is each element appropriately marked (eg manufacturer's name and gauge)?
- Do the drawings clearly specify the fixings to be used?

Infill panels

- Are service routes clearly shown on the drawings and have holes been specified through sections where required?
- Are requirements for supports to heavily loaded elements clearly shown on the drawings?
- Are fixings to primary structure clearly specified?

- Have deflection head details been clearly specified with appropriate deflection gaps?
- Have setting out assumptions (eg to minimise waste of all lining board) been clearly noted on the drawings?
- Have the implications of **BRI35 16** and the 18m rule in **AD B2 17** been addressed?

11.2 Checklist for external wall supplier

The external wall supplier should check the following:

Material ordering

- Have all materials been ordered in good time?
- Have additional lengths been ordered in case of damage on site?

Delivery

- Are deliveries properly scheduled to ensure that the correct material is on site at the right time? Generally, sections should be delivered in the sequence in which they would be installed.
- Are all materials properly marked, and has the correct quantity been supplied?

11.3 Checklist for main contractors

The main contractor should check the following aspects of the construction.

Structure interfaces

- Has the external wall supplier been provided with full information to allow the elements to be manufactured?

Setting out

- Are the primary frame slabs and soffits flat and level?
- Have diagonals been checked for 'square'?

Erection

- The main contractor may also check the aspects noted in section 11.4 for the erection supervisor.

16 <https://www.brebookshop.com/details.jsp?id=327137>

17 https://www.planningportal.co.uk/info/200135/approved_documents/63/part_b_-_fire_safety/2

11.4 Checklist for erection supervisors

The erection supervisor responsible for the external wall erection should check the following aspects of the construction.

Fabrication

- Has each element been appropriately marked (eg manufacturer's name, gauge of steel)?
- Are the section sizes as specified?
- Delivery
- Have any panels or components been damaged?
- Have all materials been stored flat on clean level areas and stacked for ease of retrieval?
- Have all steel components been kept out of contact with dry cement, lime, plaster and mortar?

External walling

After installation the following should be checked:

- Are panel cills square and level?
- Are panels plumb and square?
- Are fixings of the correct type and installed as specified?
- Have all damaged areas of galvanizing been wire brushed and recoated?
- Have service holes been fitted with sleeves or grommets where specified (eg where electrical wiring is used)?
- Have all secondary components (eg longitudinal ties) been properly installed?
- Have fixings to primary structure been installed as specified?
- Are all noggins and joints fitted flush to facilitate attachment of the plasterboard?
- Are all service holes aligned?
- Are all bottom tracks clear of debris, and are drainage holes unobstructed?

11.5 Checklist for infill wall manufacturer

The manufacturer of the infill wall system being installed may carry out site audits for quality assurance purposes. The questions given overleaf are typical questions that may be included.

SITE AUDIT REPORT				
Project name				
Site auditor				
Audit date				
Project reference				
Site contact				
Areas inspected				
INFORMATION CONTROL				
Are the latest revisions of drawings being used on site?				
Yes	<input type="checkbox"/>	No	<input type="checkbox"/>	Other
Has the client read and understood all elements of design including isometrics and specific details?				
Yes	<input type="checkbox"/>	No	<input type="checkbox"/>	Other
Does the client have specific COSHH and product information for all sections and fixings?				
Yes	<input type="checkbox"/>	No	<input type="checkbox"/>	Other
PRODUCT MANAGEMENT				
Is the material stored safely and securely in accordance with the specification?				
Yes	<input type="checkbox"/>	No	<input type="checkbox"/>	Other
Are installers taking the required health and safety precautions in product handling and installation?				
Yes	<input type="checkbox"/>	No	<input type="checkbox"/>	Other
DESIGN INSTALLATION CHECKS				
Is the installation in accordance with the details for head and base tracks?				
Yes	<input type="checkbox"/>	No	<input type="checkbox"/>	Other
Are fixings installed to design details and specification?				
Yes	<input type="checkbox"/>	No	<input type="checkbox"/>	Other
Are deflection head details constructed to design?				
Yes	<input type="checkbox"/>	No	<input type="checkbox"/>	Other
Is the deflection zone clear?				
Yes	<input type="checkbox"/>	No	<input type="checkbox"/>	Other
Are jambs, cills and lintels constructed to design?				
Yes	<input type="checkbox"/>	No	<input type="checkbox"/>	Other
Are noggins, cleats and special construction details installed to design?				
Yes	<input type="checkbox"/>	No	<input type="checkbox"/>	Other
Are sheathing boards installed in accordance with specification?				
Yes	<input type="checkbox"/>	No	<input type="checkbox"/>	Other
What is the general standard of workmanship?				
1	Best practice achieved – no remedial works required			<input type="checkbox"/>
2	Best practice not achieved – minor remedial works required			<input type="checkbox"/>
3	Major remedial works and further inspections required			<input type="checkbox"/>
Are there any special conditions and observations to be noted?				
Item	Observation			

13 REFERENCE

1 *Building Design Using Cold Formed Steel Sections*

Structural design to BS 5950-5: 1998 – Section Properties and Load Tables (P276)
SCI 2002

<https://portal.steel-sci.com/documents.html>

2 *Technical Report: Design of Light Steel Sections to Eurocode 3 (ED005)*

SCI 2012

<https://portal.steel-sci.com/documents.html>

3 *BS EN 10346: 2015*

Continuously hot-dip coated steel flat products for cold forming. Technical delivery conditions.

<https://shop.bsigroup.com/ProductDetail/?pid=000000000030280396>

4 *Durability of Light Steel Framing in Residential Building – second edition (P262)*

SCI 2009

<https://portal.steel-sci.com/documents.html>

5 *BS 5950-5: 1998*

Structural use of steelwork in building. Code of practice for design of cold formed thin gauge sections
BSI 1998

<https://shop.bsigroup.com/ProductDetail/?pid=000000000030155279>

6 *BS EN 1993-1-3: 2006*

Eurocode 3: Design of steel structures – general rules

Supplementary rules for cold formed members and sheeting (incorporating corrigendum November 2009)
BSI 2006

<https://shop.bsigroup.com/ProductDetail/?pid=000000000030207055>

7 *BS 6399-2: 1997*

Loading for buildings. Part 2: Code of practice for wind loads (incorporating amendment no.1 and corrigendum no.1)
BSI 2002

<https://shop.bsigroup.com/ProductDetail/?pid=000000000030040684>

8 *BS EN 1991-1-4: 2005 +A1: 2010*

Eurocode 1: Actions on structures. General actions. Wind actions (incorporating corrigenda July 2009 and January 2010)
BSI 2005

<https://shop.bsigroup.com/ProductDetail/?pid=000000000030206733>

- 9** *Guide to evaluating design wind loads to BS 6399-2: 1997 (P286)*
SCI 2003
<https://portal.steel-sci.com/documents.html>
- 10** *Wind Actions to BS EN 1991-1-4 (P394)*
SCI 2013
<https://portal.steel-sci.com/documents.html>
- 11** *BRE Digest 346: The assessment of wind loads. Part 8: Internal pressures*
<https://www.brebookshop.com/details.jsp?id=326937>
- 12** *Building Design Using Cold Formed Steel Sections*
Worked examples to BS 5950: Part 5: 1987 (P125)
SCI 1993
http://www.ihsti.com/CIS/document/86042_
- 13** *National Structural Steelwork Specification for Building Construction (NSSS)*
6th Edition
BCSA 2007
<https://www.ridba.org.uk/2017/06/27/national-structural-steelwork-specification-building-construction/>
- 14** *BS EN 10162: 2003*
Cold rolled steel sections. Technical delivery conditions. Dimensional and cross-sectional tolerances.
BSI 2003
<https://shop.bsigroup.com/ProductDetail/?pid=000000000030016643>
- 15** *Manual Handling at Work - a brief guide*
HSE 2012
<https://books.hse.gov.uk/Industry-Guidance-INDG/?DI=647950>
- 16** *BR 135 - Fire performance of external insulation for walls of multistorey buildings - third edition*
BRE 2013
<https://www.brebookshop.com/details.jsp?id=327137>
- 17** *AD B2*
https://www.planningportal.co.uk/info/200135/approved_documents/63/part_b_-_fire_safety/2

14 ACKNOWLEDGMENTS



FINISHES & INTERIORS SECTOR

FIS has grown over the past 50 years to become the leading trade association for the fit-out sector of the construction industry. FIS represents companies involved in the manufacture, supply and installation of all aspects of interior fit outs and refurbishment.

FIS members operate in retail and commercial offices, the public sector, banks and building societies, hotels and leisure, airports, hospitals, and so on. Most work nationally and an increasing number operate in Europe and beyond.

Quality and integrity lie at the heart of FIS's philosophy - each member is expected to act with the utmost integrity, and to exercise the highest standards of business practice and workmanship. At the same time, the Association seeks to continually raise, maintain and ensure the perpetuation of standards in order to remain a source of quality membership.

FIS membership is not automatic and applicants are subject to strict vetting procedures on application, as well as ongoing vetting. In the case of contractors, this includes inspection of recent contracts to assess workmanship standards.

www.thefis.org



The Steel Construction Institute (SCI) is the leading, independent provider of technical expertise and disseminator of best practice to the steel construction sector. We work in partnership with clients, members and industry peers to help build businesses and provide competitive advantage through the commercial application of our knowledge. We are committed to offering and promoting sustainable and environmentally responsible solutions.

Our service spans the following areas:

Membership

Individual and corporate membership

Advice

Members' advisory service

Information

Publications; education; events and training

Consultancy

Development; product development; engineering support; sustainability

Assessment

SCI Assessment

Specification

Websites; engineering software

www.steel-sci.org

NOTES

SUPPORTERS

The work leading to the original report was funded by Ayrshire Metals Ltd, BW Industries Ltd, Fusion Building Systems, Kingspan Steel Building Solutions, Metek Plc and Tata Steel Strip Products UK.



This revised guide has been supported by Acoustic and Insulation Manufacturing Ltd, Caledan, EOS Facades Ltd, Etag Fixings UK Ltd, Etex Building Performance Ltd, Euroform Products Ltd, Knauf Ltd, Stanmore Contractors Ltd, Trimble Solutions (UK) Ltd, Veitchi Group Ltd, Vertex Systems Oy and voestalpine Metsec Plc.



FIS

Olton Bridge
245 Warwick Road
Solihull
West Midlands
B92 7AH

+44(0)121 707 0077
info@thefis.org
www.thefis.org

SCI

Silwood Park
Ascot
Berkshire
SL5 7QN

+44(0)1344 636 525
www.steel-sci.org