

Wall-top and Gabion Seating.

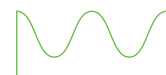



Wall-top and Gabion Seating.



Transform ordinary walls into useful seating

Although low level retaining walls are increasingly popular in landscape schemes, the hard surface isn't particularly comfortable and can often be too cold to sit on.

The addition of a timber-topped seat or bench platform onto a wall easily overcomes this by providing a secure and tidy seating solution on top of existing site features.

Upcycle your wall

Converting walls with wall-top seating is also more cost effective compared to independent seats that require a suitable base for bolting down to or excavation for an in-ground fixing.

Why Wall and Gabion top?

- Cost-effective solution compared with traditional seating with supports
- Individual or continuous lines of seating runs
- Easy to install, all ranges come with a complimentary wall-fixing kit and
- Full instructions
- A range of sizes to choose from
- Accessorise with armrests or backrests
- Designed and made by us, in the UK

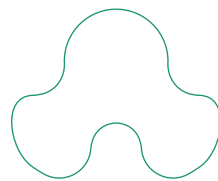
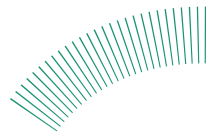

Four ranges to choose from

Each with its own distinct character, designed to suit a range of budgets and schemes.

Lapa Wall and Gabion top

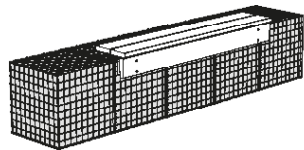
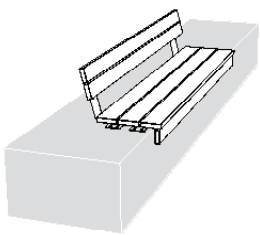

Alta

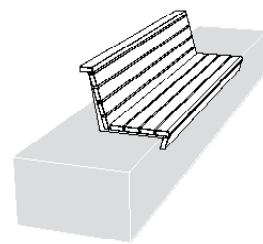

Fortis

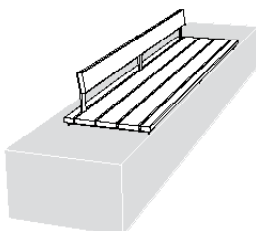

Contor

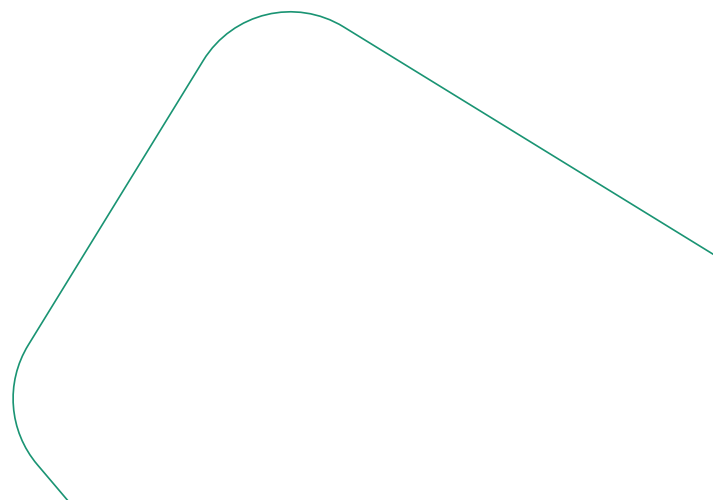
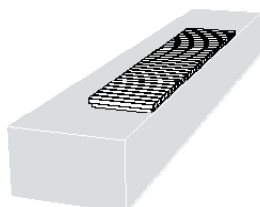

Lapa Wall-top.

Simple, economical wall-top seating

- Cost-effective seating solution
- Suitable for traditional masonry walls or gabions
- 2 widths to choose from
- Optional backrest
- Optional centre or end armrests
- Iroko timber slats – smooth or oiled finished



Lapa Wall-top.

As standard, the platform is fitted to the top of the wall only at 4 points, through brackets that are designed to align with mortar joints of a standard brick-on-edge header course, or any homogenous wall construction. An optional generic fixing kit -

comprising 4 no. sets of threaded inserts for fixing into the wall, studs, nuts and washers - can be supplied on request, though it may be more convenient to assess the dimensions and condition of the wall first, and to locally source the most appropriate fixings for the task.

2-slat deep bench platforms

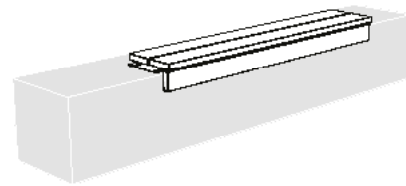
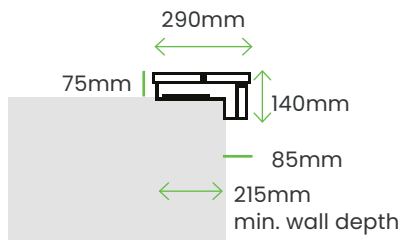

1000MM LONG X 290MM DEEP	LPW2B-2
1500MM LONG X 290MM DEEP	LPW2B-3
2000MM LONG X 290MM DEEP	LPW2B-4

3-slat deep bench platforms

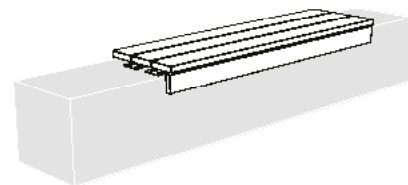
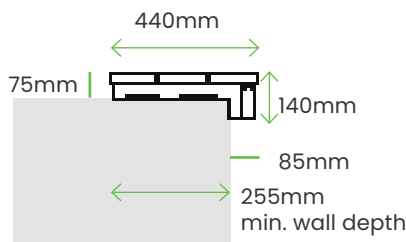

1000MM LONG X 440MM DEEP	LPW3B-2
1500MM LONG X 440MM DEEP	LPW3B-3
2000MM LONG X 440MM DEEP	LPW3B-4

3-slat deep seat platforms

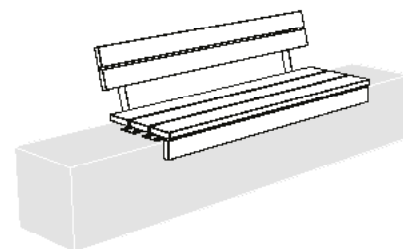
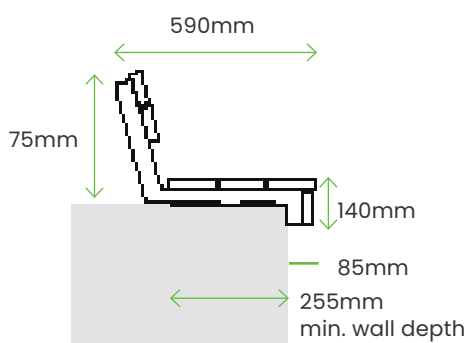

1000MM LONG X 590MM DEEP	LPW3S-2
1500MM LONG X 590MM DEEP	LPW3S-3
2000MM LONG X 590MM DEEP	LPW3S-4

Lapa Gabion-top.

Practical add on gabion platforms

- Cost-effective seating solution
- Add on to new or existing gabion walls
- 3 lengths and widths to choose from
- Optional backrest
- Optional centre armrests
- Iroko timber slats - smooth or oiled finished
- Steelwork to any RAL colour



Lapa Gabion-top.

2-slat deep bench platforms

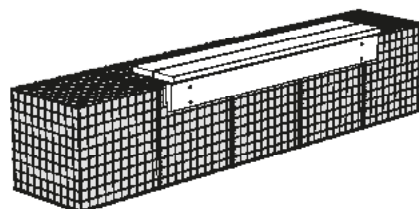
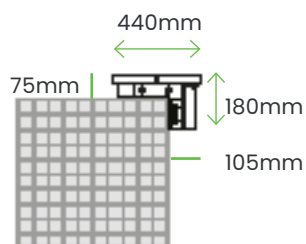

1000MM LONG X 290MM DEEP	LPA 2B 2
1500MM LONG X 290MM DEEP	LPA 2B 3
2000MM LONG X 290MM DEEP	LPA 2B 4

3-slat deep bench platforms

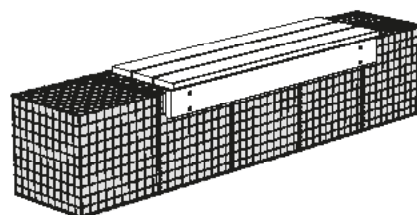
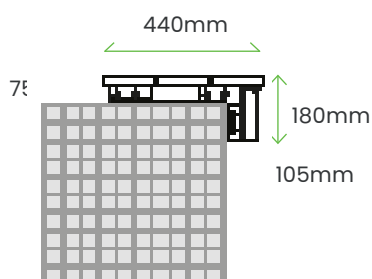

1000MM LONG X 440MM DEEP	LPA 3B 2
1500MM LONG X 440MM DEEP	LPA 3B 3
2000MM LONG X 440MM DEEP	LPA 3B 4

3-slat deep seat platforms

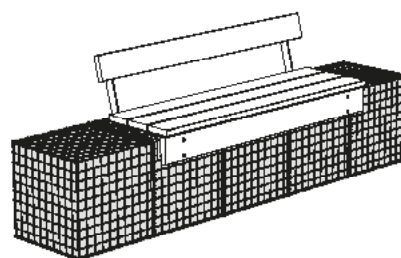
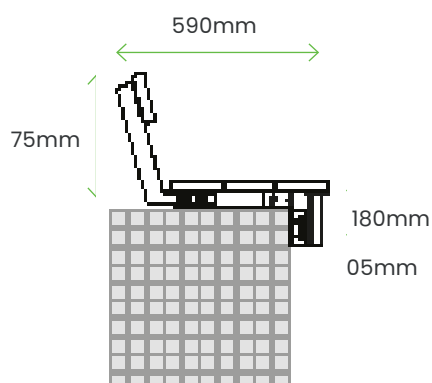

1000MM LONG X 590MM DEEP	LPA 3S 2
1500MM LONG X 590MM DEEP	LPA 3S 3
2000MM LONG X 590MM DEEP	LPA 3S 4

Fortis Wall-top.

Modular timber seating platforms

- Modular and versatile
- Various slat orientation and sizes
- Optional backrest
- Optional centre or end armrests
- 2 or 4 person widths
- Short 440mm depth version
- Iroko timber slats - smooth or oiled finished

Fortis offers two types of installation options depending on the type of look you want to achieve for your scheme.

- Directly abutted - for a linear aesthetic
- With gaps - for singular arrangements

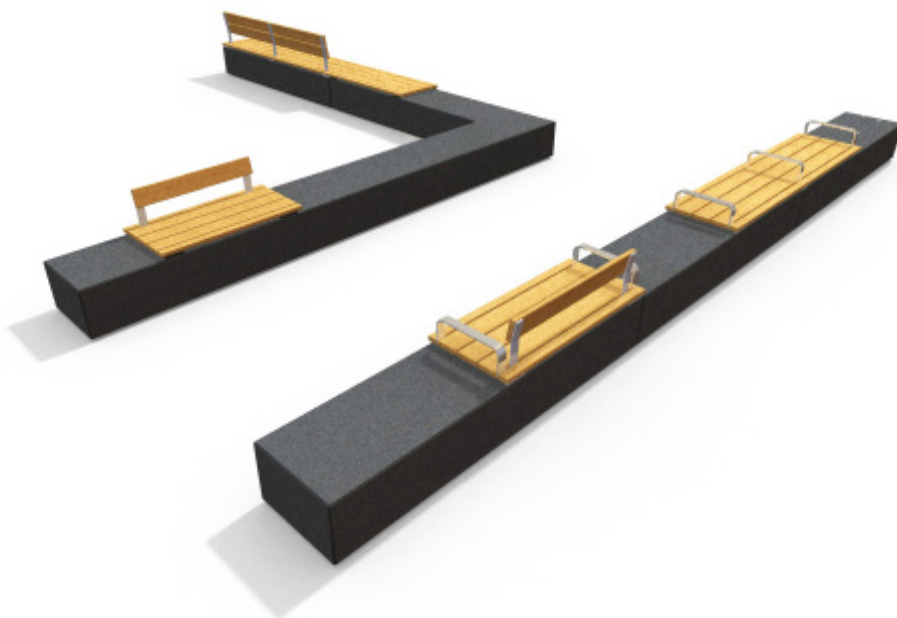

Choose your slat style.

Iroko timber slats with a choice of 3 different slat sizes; small (40mm), medium (65mm) and large (140mm) in 2 styles; front-to-back or side-to-side.

* All side-to-side layouts use a 65mm wide timber for front & back slats.

**All front-to-back layouts use a 65mm wide timber for front, back & end slats.

Side-to-back slat arrangements*

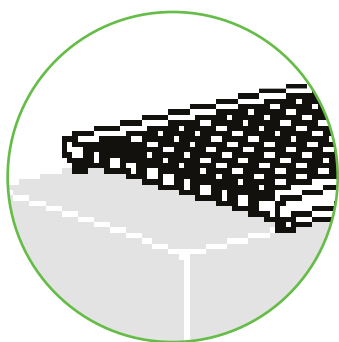

Small timbers
40mm wide

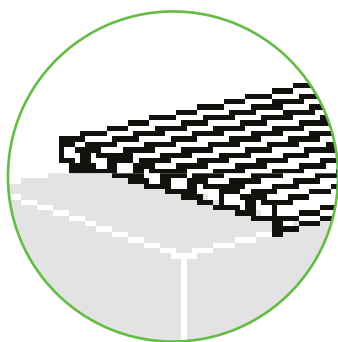

Medium timbers
65mm wide

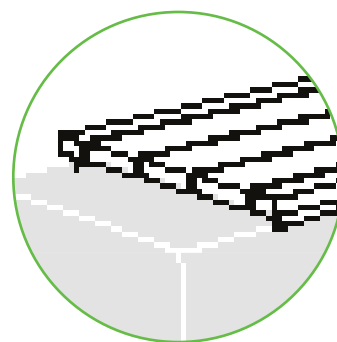

Large timbers
140mm wide

Front-to-side slat arrangements*

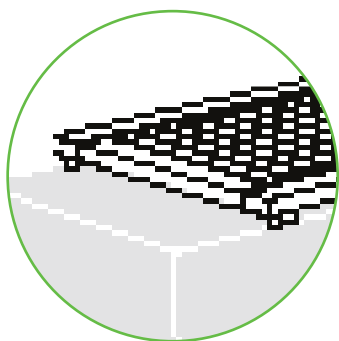

Small timbers
40mm wide

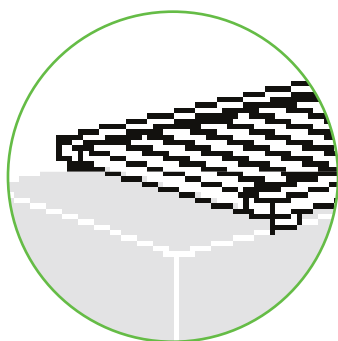

Medium timbers
65mm wide

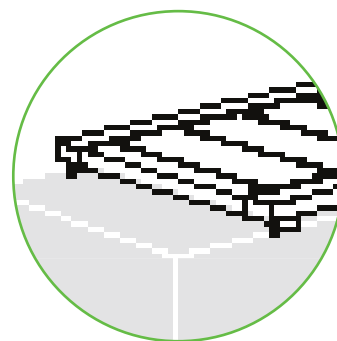

Large timbers
140mm wide

Fortis Wall-top Bench.

Short depth bench

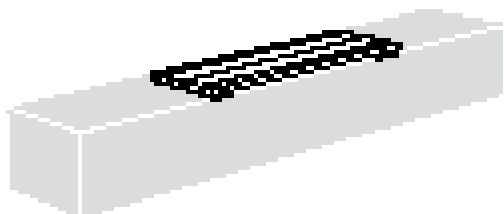

**2-PERSON BENCH PLATFORM (NO ARMS),
440MM DEEP X 1340MM LONG**

FTW2B-22L

**2-PERSON BENCH PLATFORM + END ARMS,
440MM DEEP X 1340MM LONG**

FTW2B-22LC

**4-PERSON BENCH PLATFORM + ARMS & CENTRE
ARMS 440MM DEEP X 2540MM LONG**

FTW2B-4LS

Standard depth bench

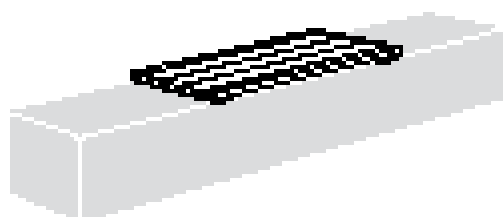

**2-PERSON BENCH PLATFORM (NO ARMS),
590MM DEEP X 1340MM LONG**

FTW3B-22L

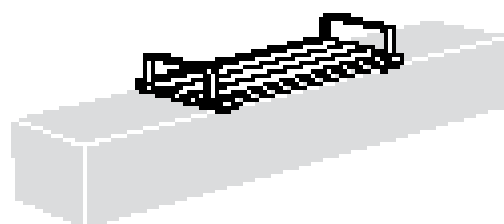

**2-PERSON BENCH PLATFORM + END ARMS,
590MM DEEP X 1340MM LONG**

FTW3B-22L C

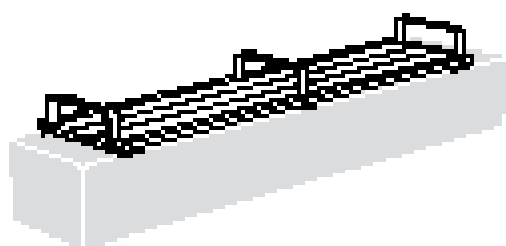

**4-PERSON BENCH PLATFORM + ARMS & CENTRE
ARMS, 590MM DEEP X 2540MM LONG**

FTW3B-4LS

Fortis Wall-top Seat.

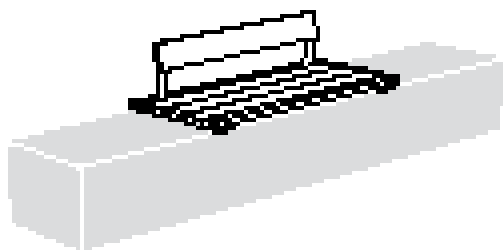

**2-PERSON BENCH PLATFORM (NO ARMS),
590MM DEEP X 1340MM LONG**

FTW3S-22L

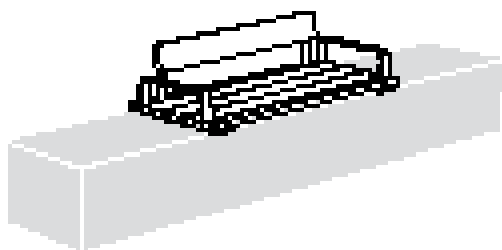

**2-PERSON BENCH PLATFORM + END ARMS,
590MM DEEP X 1340MM LONG**

FTW3S-22LC

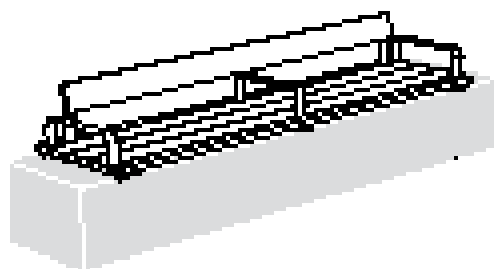

**4-PERSON BENCH PLATFORM + ARMS & CENTRE
ARMS, 590MM DEEP X 2540MM LONG**

FTW3S-4LS

Alta Wall-top.

Versatile, practical wall seats

- 4 different designs - flat bench platforms, platforms with back-stops, full height and enclosed backrests
- 3 size options - 1000mm, 1500mm, 2000mm
- Material and finish - steel and (PPC) to any RAL colour
- Iroko timber slats - smooth or oiled finished



Alta Wall-top Bench.

Standard depth bench platforms

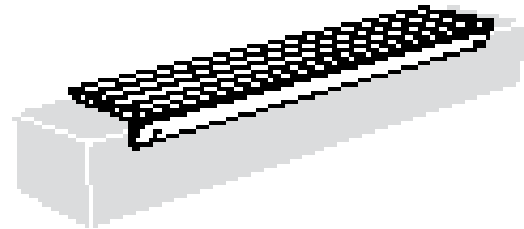
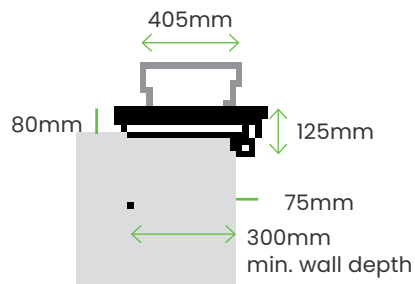

1000MM LONG X 405MM DEEP

ALW4B-2

1500MM LONG X 405MM DEEP

ALW4B-3

2000MM LONG X 405MM DEEP

ALW4B-4

Extended depth bench platforms

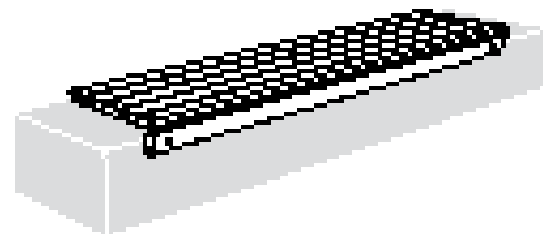
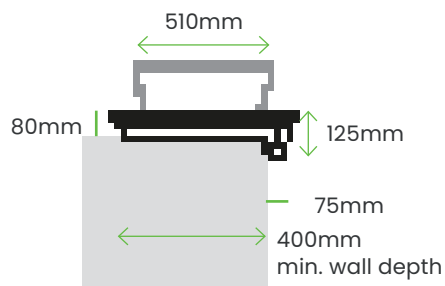

1000MM LONG X 510MM DEEP

ALW5B-2

1500MM LONG X 510MM DEEP

ALW5B-3

2000MM LONG X 510MM DEEP

ALW5B-4

Alta Wall-top Back-stop.

Standard depth back-stop bench platforms

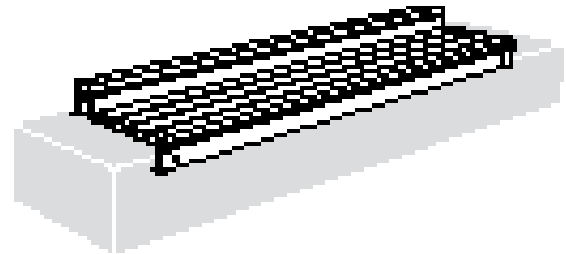
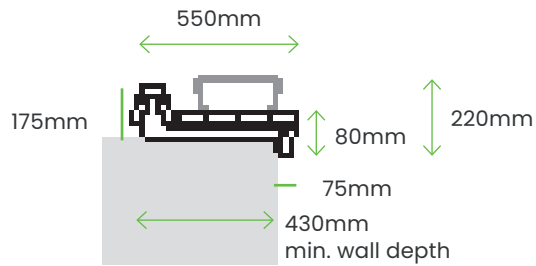

1000MM LONG X 550MM DEEP

ALW4X-2

1500MM LONG X 550MM DEEP

ALW4X-3

2000MM LONG X 550MM DEEP

ALW4X-4

Extended depth back-stop bench platforms

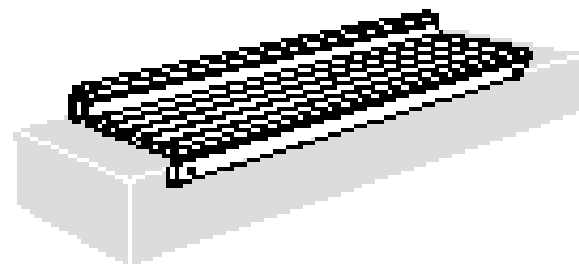
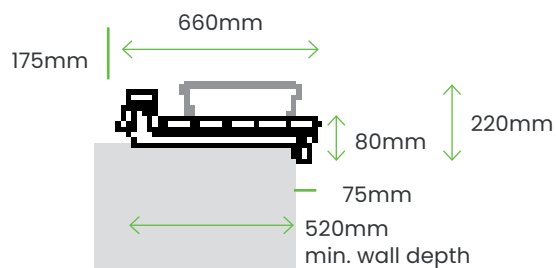

1000MM LONG X 660MM DEEP

ALW5X-2

1500MM LONG X 660MM DEEP

ALW5X-3

2000MM LONG X 660MM DEEP

ALW5X-4

Alta Wall-top Seats.

Alta offers two types of installation options depending on the type of look you want to achieve for your scheme.

- Directly abutted - for a linear aesthetic
- With gaps - for singular arrangements

Open back Seats

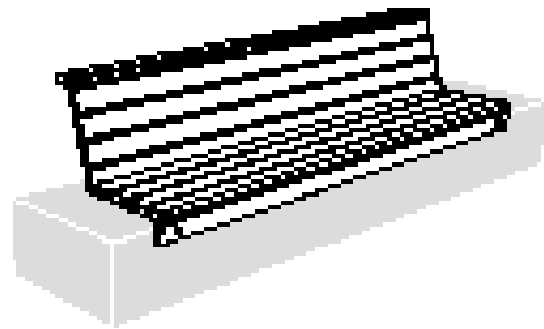
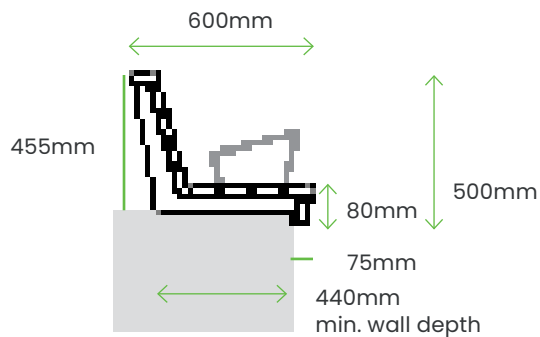

1000MM LONG X 600MM DEEP

ALW4S-2

1500MM LONG X 600MM DEEP

ALW4S-3

2000MM LONG X 600MM DEEP

ALW4S-4

Enclosed back Seats

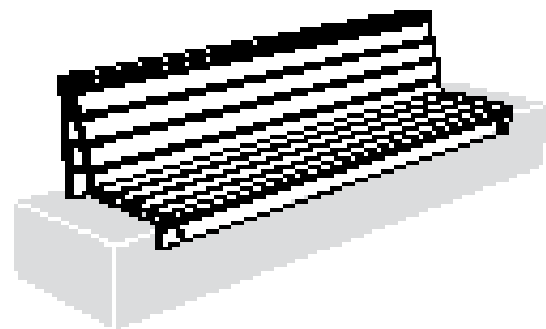
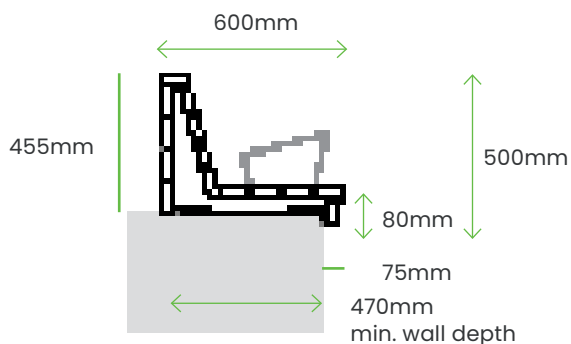

1000MM LONG X 660MM DEEP

ALW4E-2

1500MM LONG X 660MM DEEP

ALW4E-3

2000MM LONG X 660MM DEEP

ALW4E-4

Contor Wall-top.

Low-profile wall-top seating

- Single platform module size
- Straight or curved
- Front-to-back slats
- Accommodates 2 people
- Multiple units can be directly abutted to form longer seating lengths
- Materials - Iroko hardwood or Wood Plastic Composite (WPC)
- Ideal to create amphitheatre seating

As standard, the platform is fitted to the top of the wall at 4 points, through the steel sub-frame with slots designed to align with mortar joints of a standard wall construction.

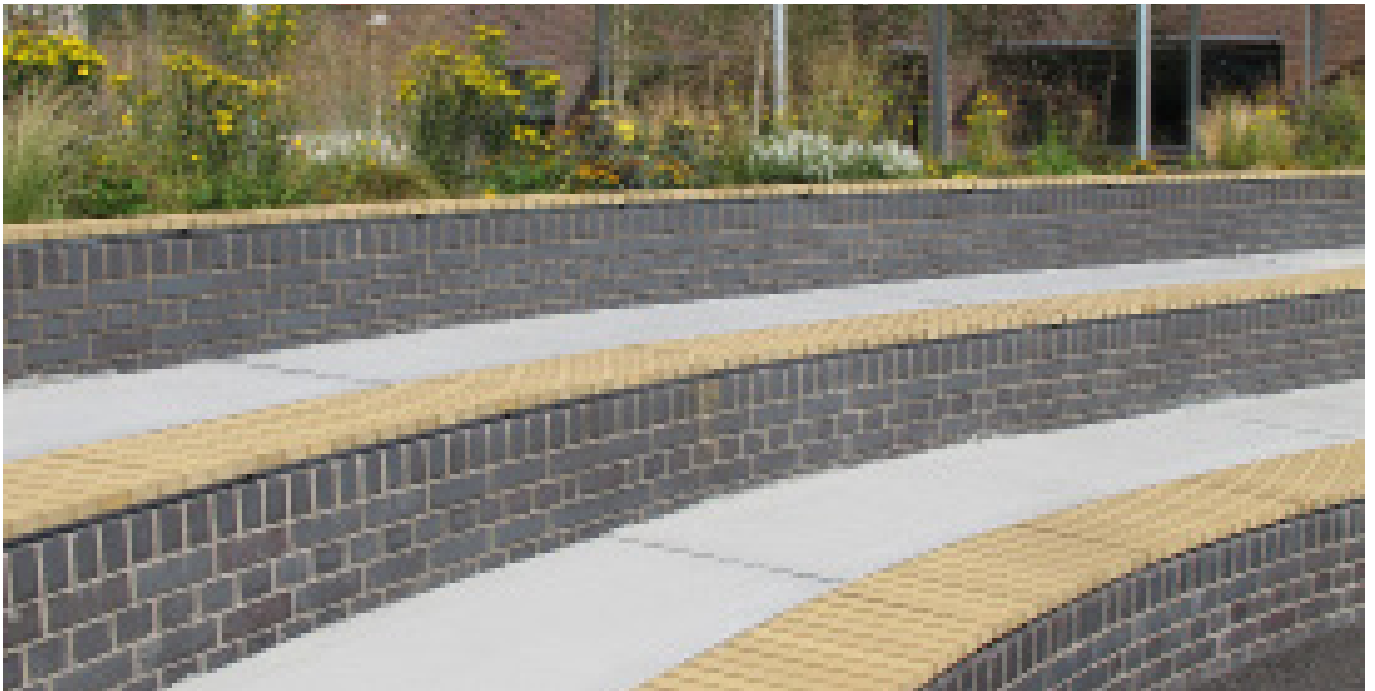

Contor Wall-top Seats.

Open back Seats

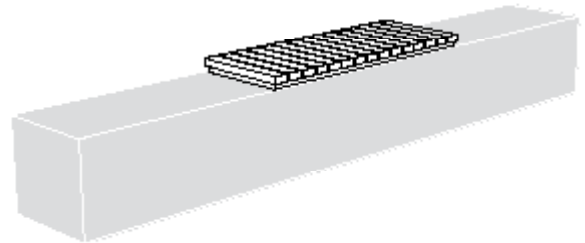
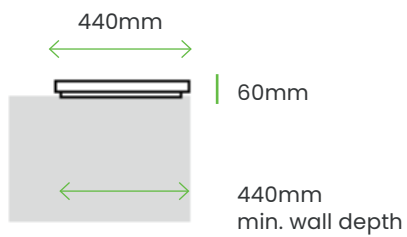

**1115MM LONG X 440MM DEEP,
NO ARMRESTS**

CNWFBN-1115

Enclosed back Seats

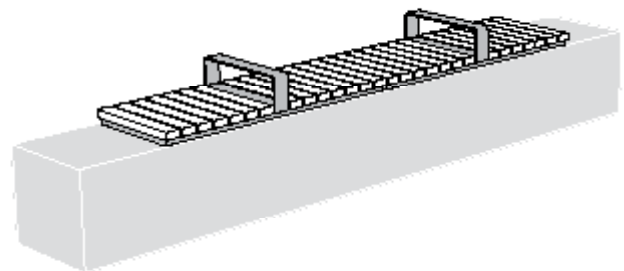
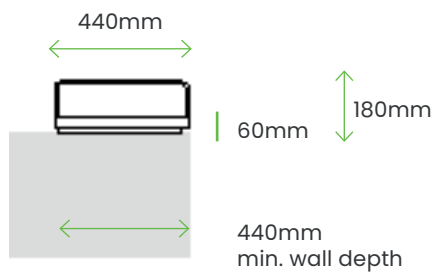

**1115MM LONG X 440MM DEEP,
WITH SINGLE CENTRAL ARMREST
IN MILD STEEL,
HOT DIPPED GALVANISED FINISH**

CNWFBA-1115

Case studies.

Some of our recent projects where you can see Wall-top in its full glory



**Ashford Designer Outlet
Expansion, Kent**
Client: McArthurGlen

Case studies.



Case studies (Bespoke).

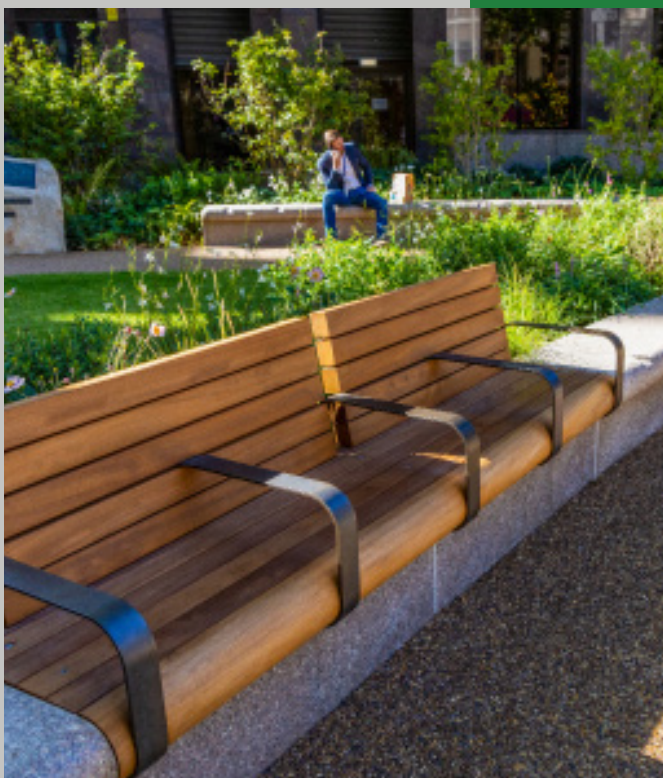

BESPOKE:
Christchurch Gardens,
Westminster, London
Client: Victoria Business
Improvement District

Why Furnitubes.

- **Made in the UK**
our factory is based in Kent, so expect faster leadtimes and no supply chain delays
- **Easy to maintain + low labour costs**
we make sure that fixing points are easily accessible so slats and brackets can be changed easily when damaged
- **Modular solutions**
our ranges are modular and customisable, seating and planters can be easily combined, be creative without blowing the budget
- **Our approach**
we take a considered approach to design, it's not just about the end product. We take everything in the process into consideration, we are collaborative and we are committed to producing products that improve our environment & keep people safe.



Our Process.

- **Get in touch** – it's as simple as that, give us a call or drop us an email, we're happy to help whatever the medium!
- **Collaborate** – Depending on your needs, you might not actually need us at this stage, that's the beauty of our modular ranges – they're designed with you in mind, so you can specify with ease. Nevertheless, we are here for you if you do – our design team are always on hand to discuss the nitty gritty of your project.
- **Specification** – This is where our team of experts take the wheel and help you with sketches, CADs and more to help you specify our products as easily as possible.
- **Production + delivery** – all of our products are designed and manufactured in the UK allowing us to give you shorter lead times. With a dedicated project manager keeping you in the loop, you can trust everything is in hand.





Furnitubes



Furnitubes



Furnitubes International UK

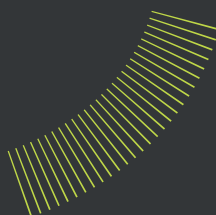

furnitubes
shaping outdoor spaces

T: +44 (0)20 8378 3200
E: sales@furnitubes.com
www.furnitubes.com