



[www.himacs.eu](http://www.himacs.eu)

# HI-MACS®

## General Brochure 2019

Great ideas made possible  
with HI-MACS®



Natural Acrylic Stone™

What is HI-MACS®?	Page 03
HI-MACS®. Because Quality Wins.	Page 04
Material properties	Page 05
Working with HI-MACS®	Page 06
HI-MACS® Quality Club	Page 07
Ecology	Page 08
HI-MACS® Collections 2019	Page 09 – 24
HI-MACS® Projects	Page 25 – 59
LG Hausys Network	Page 60
Specifications	Page 61 – 63
HI-MACS® colours	Page 64 – 67
Sinks and Basins	Page 68 – 71
Contact	Page 72



Living Spaces

Page 46 – 49



Bathroom

Page 50 – 51



Furniture Design

Page 52



Airport

Page 53



Outdoor

Page 54 – 55



Education

Page 56



Marine Industry

Page 57

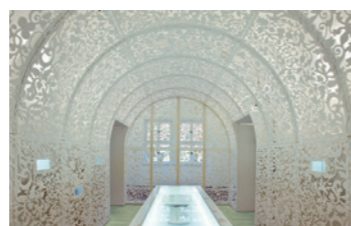

Best of the Last Decade

Page 58 – 59



Public Buildings and Offices

Page 26 – 31



Facades and Wall Cladding

Page 32 – 33

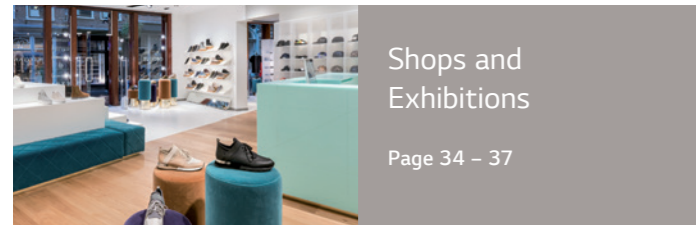

Shops and Exhibitions

Page 34 – 37



Hospitality and Gastronomy

Page 38 – 41



Healthcare

Page 42 – 43

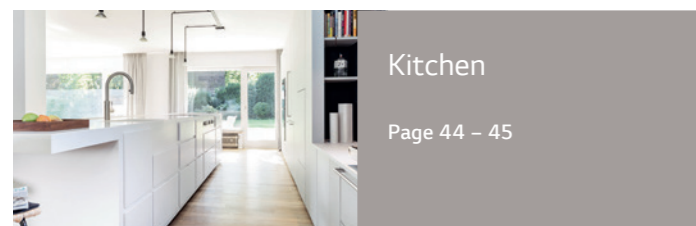

Kitchen

Page 44 – 45

# What is HI-MACS®?

## An outstanding material.

HI-MACS® is a delicate composition of acrylic, minerals and natural pigments that combine to create a smooth, non porous, thermoformable and visually seamless surface.

The material meets the highest standards for quality in all respects: material performance, fabrication, functionality and hygiene. Thanks to these qualities and the outstanding flexibility in fabrication and design, HI-MACS® offers countless advantages over conventional materials.

## And an ongoing inspiration.

We have gathered a number of projects here, all of which are capable of inspiring and creating a desire to tread new paths.

## HI-MACS®. Because Quality Wins.

Photographed by Rafael Krötz

**Quality is the longest warranty in the market.**  
We support our Quality Club Members with a 15 year warranty.  
The longest warranty in the solid surface market.

**Quality is in our DNA.**

HI-MACS® benefits from the high-tech infrastructure and development-experience of the LG Group who regularly bring stunning innovations to life. LG guarantees superior quality for all raw materials; the acrylic in HI-MACS® is produced by our own factories, certifying excellence from the source.

**Quality is available.**

We stock the entire colour and product range in one European central warehouse and 40 local warehouses in Europe.

**Quality is worldwide support.**

Full access to LG after-sales support and fabrication network worldwide.



**Quality is an excellent network of highly skilled craftsmen.**

Our highly skilled fabrication partners enjoy regular training to provide you with the best possible product. They have access to the best in class training material and support. The most skilled fabricators of HI-MACS® are easy to identify as they are certified members of the HI-MACS® Quality Club. Contact us for your nearest member.

**Outstanding features abound.  
A compelling material.**



**Simple processing**

Although HI-MACS® is almost as robust as stone, it can be worked in the same way as wood. Using conventional carpenters' tools, this solid surface material can be sawn, routed or drilled. Thanks to the new Thermalcure-technology the surface of HI-MACS® performs better than the standard in Solid Surface. You save precious time because it is easier to work with.



**Seamless perfection**

HI-MACS® allows for visually seamless fabrication. Smooth integration creates large areas without visible joints or edges as well as the flush mounting of bowls. This results in extremely hygienic, easy-to-clean installations, ideally suited for use in hospitals and laboratories.



**Three-dimensional design**

HI-MACS® boasts a simple heating process and three dimensional thermoforming capabilities. This enables greater forming flexibility compared with other conventional materials so that spectacular ideas can quickly take on a concrete shape. HI-MACS® Ultra-Thermoforming formula allows the material to be better shaped; the minimal internal radius of 6 mm (previously 50 mm) opens a wholly new design dimension.



**Dramatic translucency**

Certain colours and thicknesses of HI-MACS® exhibit a subtle translucency when exposed to light. The translucent properties of HI-MACS® make it the perfect choice for lamps and illuminated furnishings.



**Huge colour spectrum**

Colour selection is a crucial factor when it comes to high-quality design. HI-MACS® offers an enormous range of colours. No matter what colour you choose, HI-MACS® remains 100% homogeneous.

All fabrication pictures on this page: Photographed by Dominik Oberreis  
Sample picture: Photographed by Petr Krejčí

Working with HI-MACS® is easy.  
Everything you need will already be in your workshop.



As a woodworking expert, you only need to open your workshop to find everything you need: talented craftsmen and tools for working with hardwood. That's all you need to saw, drill and sand this material.

And if you have a pre-heating oven or a heating press, then you'll find it easy to heat the material for thermoforming. That's all there is to it: the carpentry workshop that once specialised in timber materials, is transformed in an instant into a company that can also offer modern stone products as well.

## Welcome to the HI-MACS® Quality Club.

The members of the HI-MACS® Quality Club are our closest partners when it comes to working with the material and experiencing its tangible benefits:

- We train our partners with a comprehensive training programme, the best trainers and the best working manual.
- We cooperate closely with our Quality Club members on all material and work-related questions and guarantee comprehensive technical support.
- We also actively support our partners in sales, including forwarding specific project enquiries.
- Our partners benefit from our Europe-wide marketing and communication strategy: PR, traditional advertising, online communication, social media, as well as involvement in all the relevant industry events.
- Partners who belong to the HI-MACS® Quality Club are exclusively able to offer a 15-year material guarantee, the longest guarantee in the solid surface market, and thus gain a crucial competitive edge when pitching for projects.



Join the HI-MACS® Quality Club!  
Certify your fabrication expertise by taking part in our Training Programme and become a HI-MACS® Quality Club Member.



Thinking green means caring about our environment throughout the whole product life-cycle

Environmentally friendly products are a necessity nowadays. What is even better is when the entire product cycle – from its production and transport through to its disposal – meets the highest environmental standards. LG Hausys leads the way in terms of environmentally responsible action on a global scale, always staying true to this promise. We take environmental actions very seriously.

©iStockphoto - 4maksym

#### These facts speak for themselves.

**1. Material composition:** Aluminium trihydroxide, the main component of HI-MACS®, is a resource-efficient bi-product of Bauxite (aluminium production). This allows a valuable raw material, that would otherwise be discarded without being used, to be utilised in a meaningful way (“**Second life concept**”).

**2. Material safety:** Extensive studies – within LG Hausys’ own laboratories as well as tests carried out by other renowned independent institutions – have shown that the HI-MACS® material itself, as well as the cured adhesive, are **completely free from formaldehyde and emissions**. HI-MACS® has been awarded the Greenguard Gold Indoor Air Quality Certificate.

**3. Manufacturing process:** The production of this solid surface material is marked by an excellent energy balance. In recent years, the company was very successful in achieving ambitious goals in terms of waste reduction and water conservation. In addition, HI-MACS® plants in Cheongju (Korea) and Atlanta (USA) meet all environmental standards.

**4. Transport:** Within Europe, HI-MACS® observes the Euro-5 standards for reduced particulate emissions. The partner-network of LG Hausys Europe consists of carefully selected partners with the highest environmental

standards: for example, the State-of-the-Art logistics centre in the Netherlands is one of the first buildings to have been constructed in accordance with the WELL Building Standards and awarded the BREEAM Certificate. This means that it meets the highest requirements for environmentally friendly and healthy construction.

**5. Processing:** The material allows for virtually waste-free processing. In addition, HI-MACS® installations are extremely strong and durable. They can easily be renewed to their original appearance, meaning they don’t have to be replaced, thus giving a positive long-term environmental footprint.

**6. Awards, certificates and regular testing:** Numerous internationally recognised certificates show the strong focus of LG Hausys on environmental issues. Without exception, all HI-MACS® products are manufactured in accordance with environmental standard ISO:14001. LG Hausys also voluntarily submits to regular environmental audits and energy consumption analyses, publishing the results afterwards. By using low-emission fuels, for example, the greenhouse gas emissions have been reduced by 15,000 tonnes per year since 2008.

#### The Eden collection. Eco-friendly through and through.



The Eden colour collection by LG Hausys is an environmentally friendly solid surface material available on the market today. This one-of-a-kind colour palette consists of up to 35% recycled materials and is available in 8 warm, natural shades.

The Eden collection has been recognised by the U.S. Scientific Certification System for the large proportion of recycled material it uses. Furthermore, projects made from HI-MACS® Eden are eligible for LEED (Leadership in Energy and Environmental Design) certification from the U.S. Green Building Council, and may receive up to 2 credits in various LEED categories. Another solid and sustainable reason to choose HI-MACS®.

# The HI-MACS® Collections 2019.

More than the sum of the parts.

MARMO COLLECTION



MARMO COLLECTION



There is currently a revival of marble shades – Marmo's natural and individual design adds a unique signature with special character and elegance to each design.

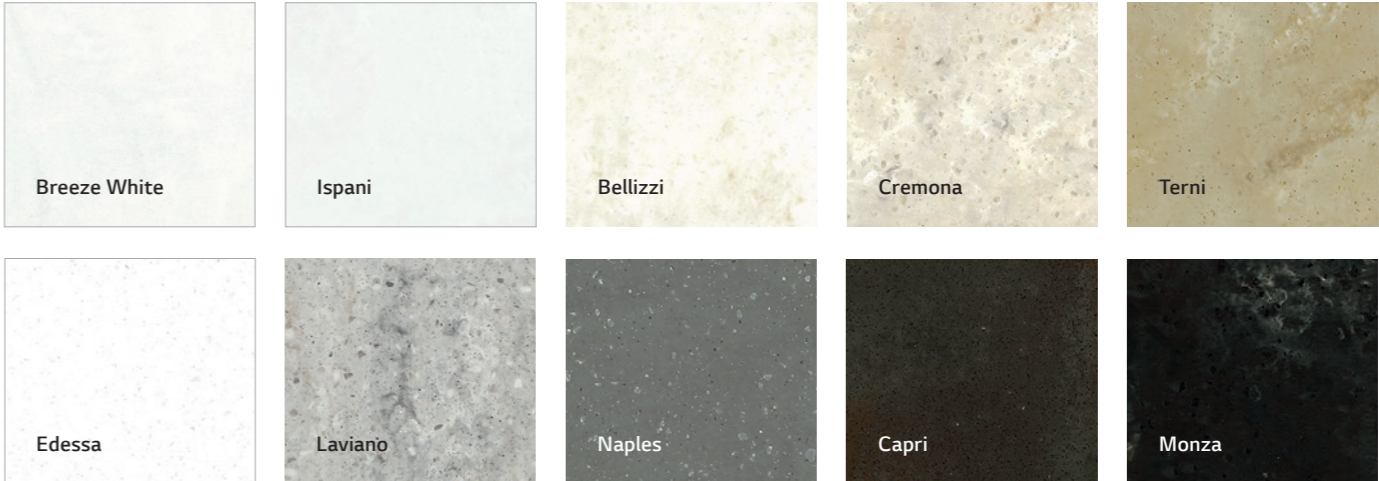

## CONCRETE COLLECTION



The industrial look of concrete combined with the incredible flexibility of HI-MACS®. The Concrete Collection adds huge opportunities for great designs to architects and designers.

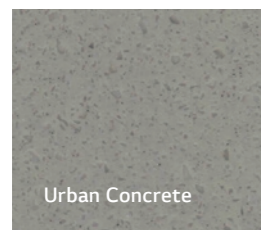

Urban Concrete

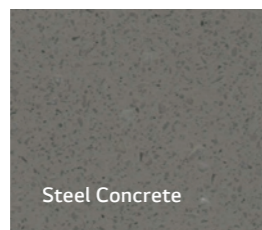

Steel Concrete



Chic Concrete

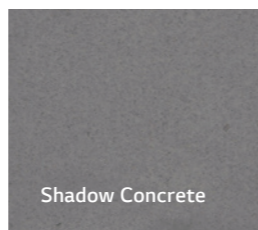

Shadow Concrete

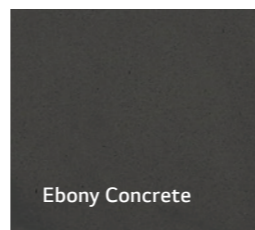

Ebony Concrete

## LUCIA COLLECTION



Lentil

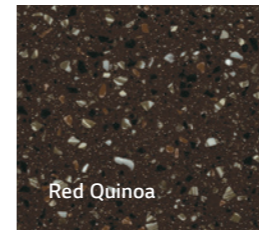

Red Quinoa

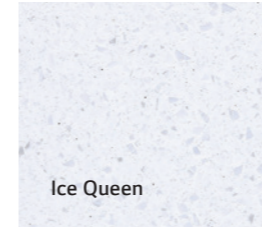

Ice Queen

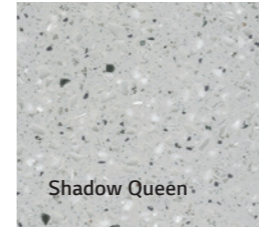

Shadow Queen

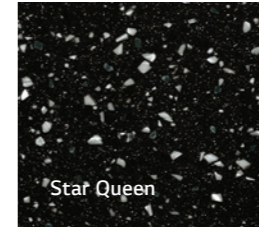

Star Queen

This collection focuses on the natural trend colours black, white and grey. The lively and homogeneous structures add character and expression to the colours. Not surprising, as the renowned Dutch designer, Marcel Wanders, designed three of these colours.



# VOLCANICS COLLECTION

The large particles of the Volcanics shades add a sense of style to any design. When used on a large scale the result is a dramatic showpiece.

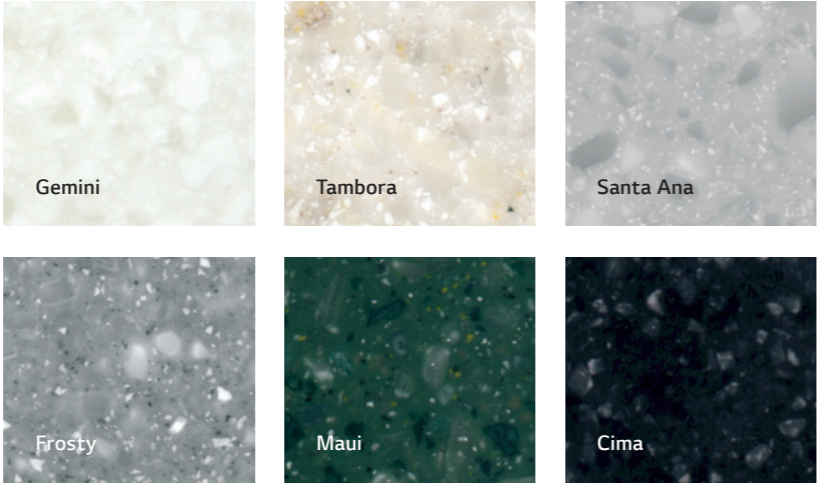

Translucency and effective use of light are decisive design elements of contemporary architecture – the shades of the Lucent Collection, with their exceptional light translucency, allow for spectacular designs. Whether effectively backlit or simply illuminated, the Lucent colours of the architecture always add an elegant touch thanks to their characteristic reaction to light.

# LUCENT COLLECTION

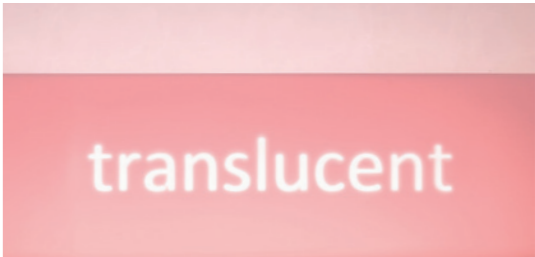
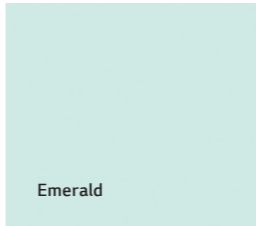
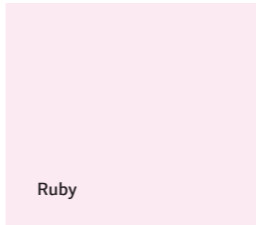
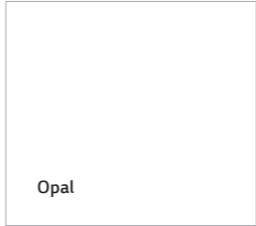

Oblique Men - Design: The Invisible Party - Fabrication: Van Assem Interieurbouw - HI-MACS® Supplier: Baars & Bloemhoff, The Netherlands - Material: HI-MACS®, Emerald - Photographed by Sal Marston Photography

Raffaelsen Bank Mendrisio - Design by Studio d'architetture Casali Sagli - Fabrication: Il Falegname Fabrizio Sagli - Material: HI-MACS® Opal - Photographed by Claudio Bader

PWS Broad Oak Rye - Design: Graeme Smith - Fabricator: PWS Worksurfaces - Material: HI-MACS® Santa Ana - Photographed by Tim Morris



## SOLIDS COLLECTION

The classic in terms of solid surfaces – a wide range of attractive shades of white lies at the heart of this collection. Complemented by colourful, dynamic uni-shade accents from Lemon Squash to Festival Pink. The timeless collection offers the perfect colour for every design.

Alpine White	Nordic White	Diamond White		
Arctic White	Ivory White	Nougat Cream		
Satin White	Cream	Almond	Babylon Beige	Toffee Brown
Suede	Grey	Marta Grey	Steel Grey	Concrete Grey
Lemon Squash	Banana	Orange	Fiery Red	Festival Pink
Light Green	Sky Blue	Evergreen	Deep Indigo	Cosmic Blue
Midnight Grey	Mink	Dark Night	Coffee Brown	Black



Design: Herrmann Flavio - Fabrication: IL Falegname Fabrizio Sagl - HI-MACS® Supplier: klausler acrylstein ag, Switzerland - Photographed by Claudio Bader

## ASTER COLLECTION



Studio Podrini, studiopodrimicom

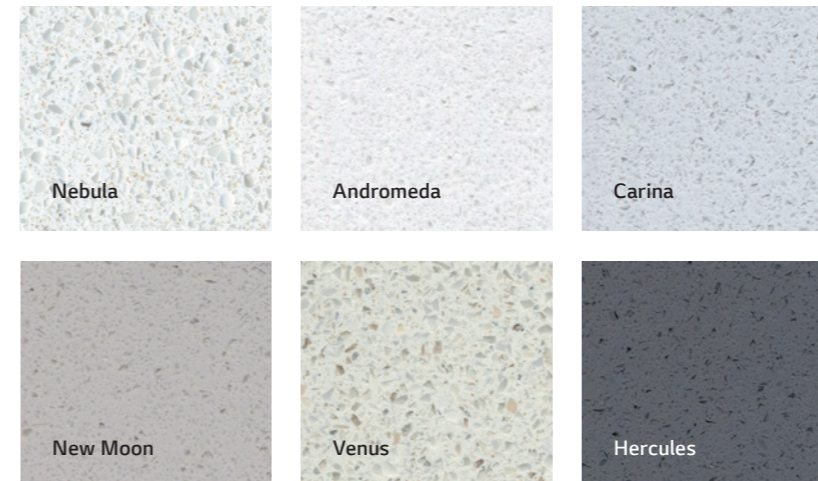

Aster is a collection of elegant shades of grey, ranging from almost white to a dramatic dark grey, all with a gorgeous mother of pearl shimmer.

## GRANITE, SPARKLE, QUARTZ, SAND & PEARL COLLECTIONS

Ultimate elegance thanks to lively textures, harmoniously natural tones and maximum subtleness. The Sparkle, Sand & Pearl, Granite and Quartz collections are perfect either alone or in combination with other colours.

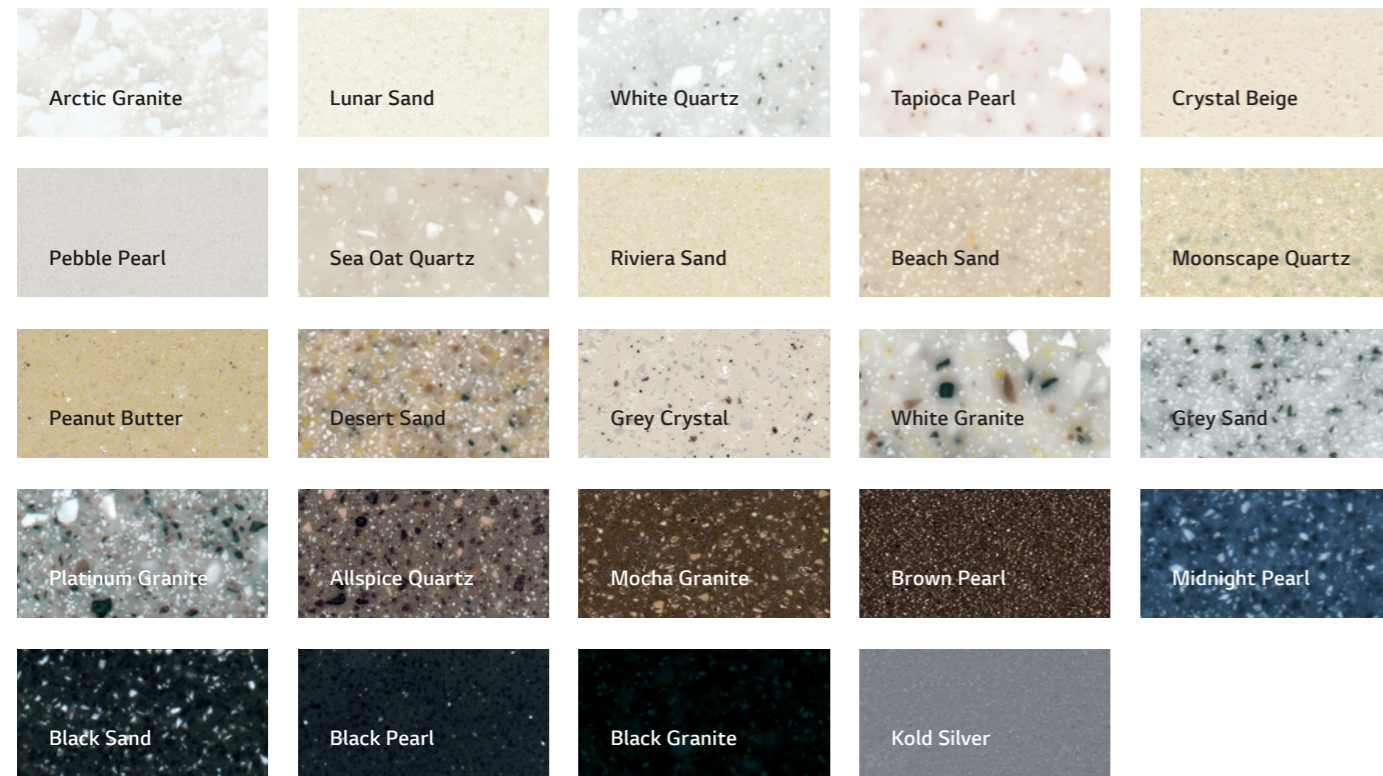

## HI-MACS® ULTRA-THERMOFORMING & HI-MACS® HIGH-PERFORMANCE ADHESIVE

Permanent innovation is in our DNA

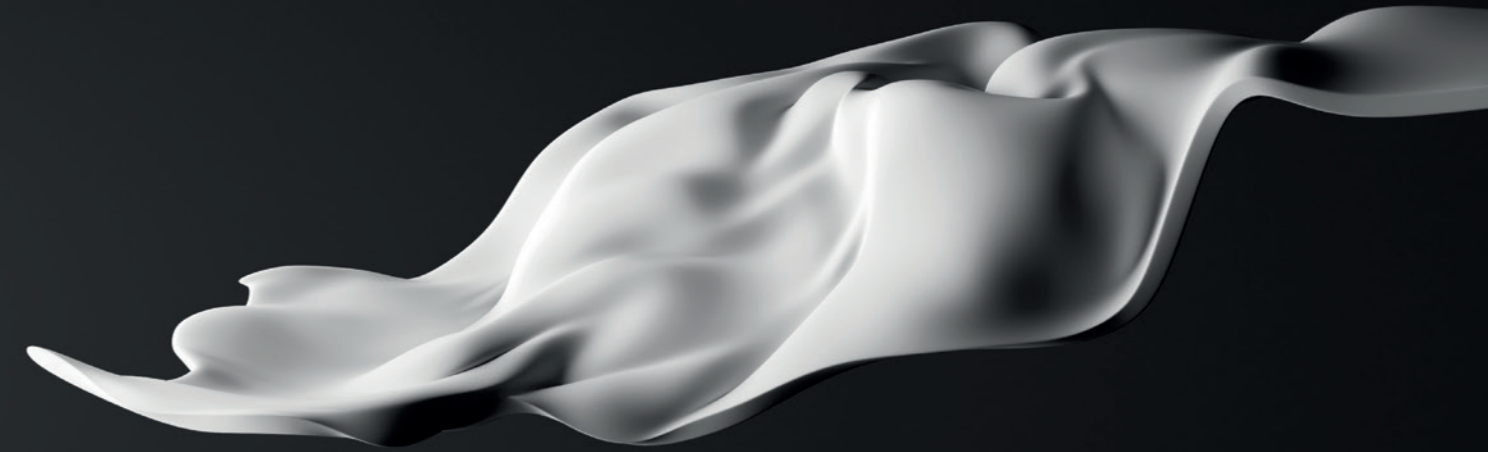

### HI-MACS® Ultra-Thermoforming: Extreme curves

The HI-MACS® Ultra-Thermoforming formula allows for even more extreme curves. The minimum inner radius of 6 mm (usually 50 mm) offers a completely new design dimension. This product has 30% greater flexibility, which allows designers to create much sharper curves. Even the smallest radii can be created without affecting the material properties.

Especially in furniture design, where it is often about filigree details, but also in the kitchen and bathroom, the new feature offers clear advantages: the radii of deep-drawn basins can be made significantly smaller, which improves the appearance and size of the basin.

The new ultra-thermoforming quality in popular Alpine White is available in a thickness of 12mm and can be used indoors and outdoors. The same warranty conditions apply as for all other HI-MACS® sheets.

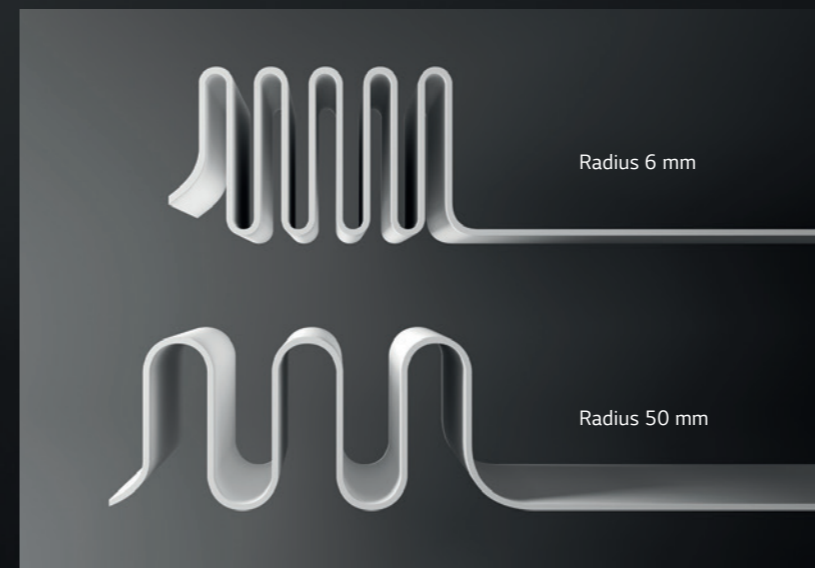

### HI-MACS® high-performance adhesive: lives up to its promise

The main task of adhesives is to combine two parts permanently – our adhesive with improved formulation does this perfectly, thanks to its much stronger bond. In addition, its viscosity has been significantly improved; this means it can be used more precisely, eliminating any annoying “bleeding”. The adhesive’s UV resistance is also improved.

All images on this page: Studio Podrini, studiopodrimi.com



"Arc" - Design: OS A DOS - Fabrication: Bone Solid - Material: HI-MACS® Black Sand, Black Pearl - HI-MACS® Supplier: Baars & Bloemhoff, The Netherlands - Photo credit: ©Patrick Meis

# Perfect for kitchen, laboratory and bathroom.

With HI-MACS®'s comprehensive sink and basin range, creative planners have all the options to design sanitary facilities, kitchens, hospitals and much more. All sinks can be flushmounted or undermounted using sheet material. In addition to the standard range, customised solutions are also available.



The perfectly coordinated sinks can be installed flushmount or undermount. The result is extremely hygienic, easy to maintain units from a single cast. Perfect for the kitchen and laboratory.

# HI-MACS® SINKS & BASINS



Pleasantly warm to the touch, easy to maintain: Washbasins from HI-MACS® are manufactured using the casting process and are ideally suited to under-mounted installation.



In addition, the HI-MACS® top-mounted range offers three exclusive countertop basins that perfectly capture the trend of linear bathroom designs.



All images on this page: Studio Podrini, studiopodrini.com

# The next dimension in texture design: HI-MACS Structura® gives you limitless possibilities!

HI-MACS Structura® surfaces have a 3D textured appearance. They have a better finish and can be more cost effective than a CNC produced panel.

Have you ever wanted to offer a textured surface, one that required a high level of craftsmanship? Thanks to HI-MACS Structura® technology, HI-MACS® can take on virtually any pattern – and do so with the utmost precision. Choose from either the ten standard surfaces available, or design your HI-MACS Structura® product yourself to meet the needs of your project design.



HI-MACS STRUCTURA®



## A winner from the beginning

The side table "Trace" from the Swiss brand strasserthun has won the renowned German Design Award. The characteristic table legs are made of HI-MACS Structura®. The design of the table and the patterned HI-MACS Structura® surface comes from the designers Kepenek GmbH.



HI-MACS Structura® was awarded the prestigious archiproduct DESIGN AWARD 2017 in the Components and Materials category for its outstanding quality in aesthetics, material and workmanship.

## The ten standard HI-MACS Structura® designs.

These ten attractive surface designs provide a perfect base for limitless design ideas: minimalist and graphic like Classic, with dynamic lines like Air Stream or, like Zen, with a surface reminiscent of ingrained pebbles. HI-MACS Structura® offers one more dimension than conventional sheet material.

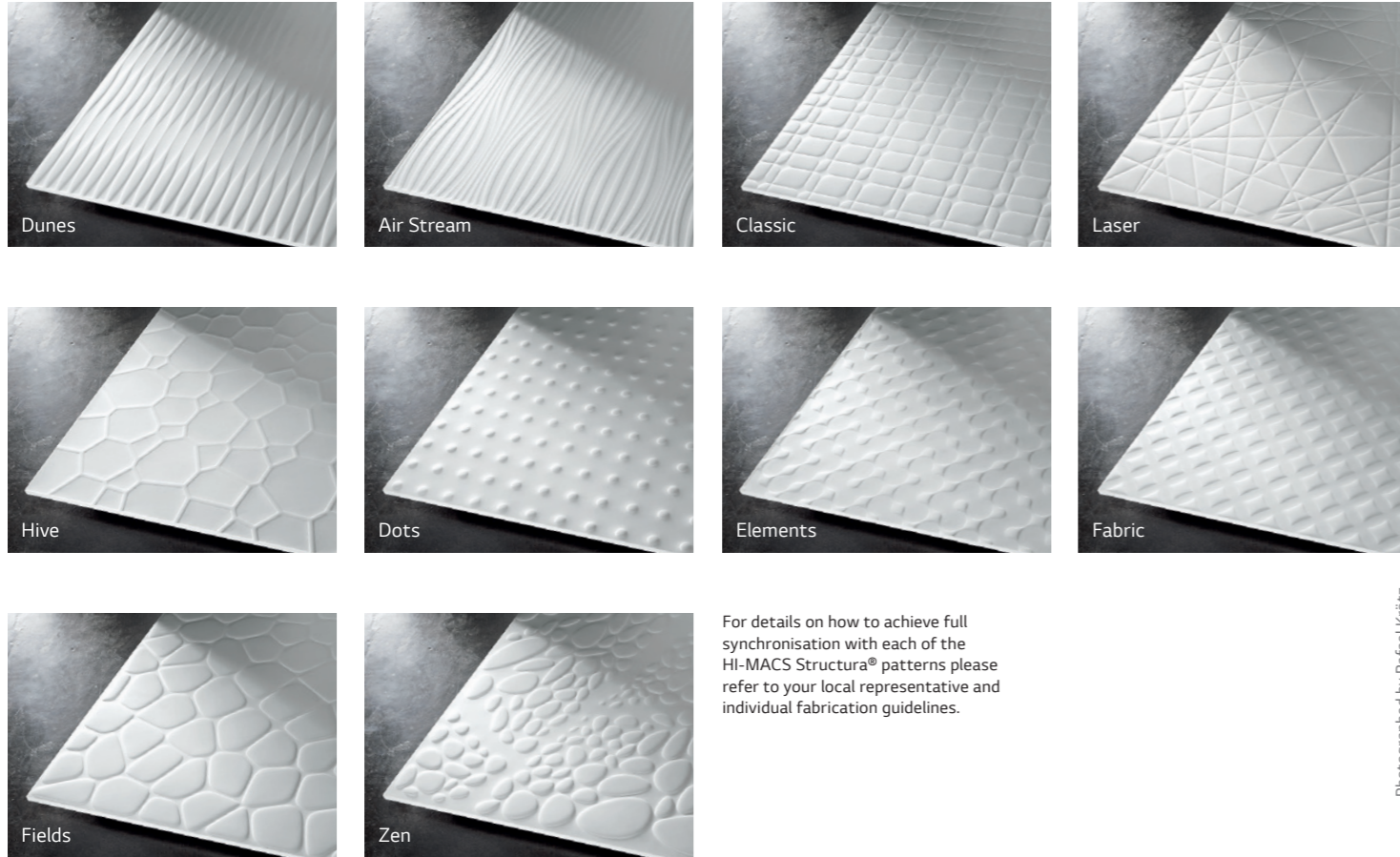

For details on how to achieve full synchronisation with each of the HI-MACS Structura® patterns please refer to your local representative and individual fabrication guidelines.

Photographed by Rafael Krötz

# HI-MACS® Projects

Great spaces and installations from all over Europe.

## Technical information

Prior to ordering, it is imperative that you consider the general technical requirements of HI-MACS Structura® technology. Your consultant will be happy to answer your questions at any time.

### Available sheet formats

SHEET THICKNESS IN MM	SHEET WIDTH IN MM	SHEET LENGTH IN MM	SHEETS PER PALLETTE	COLOUR
12	760	3050	15	S028 Alpine White S006 Arctic White S001 Satin White S005 Grey S009 Cream S022 Black S025 Fiery Red S029 Ivory White S033 Nordic White S034 Diamond White
9	760	3050	20	S028 Alpine White
6	760	2490	30	S028 Alpine White

### Embossing depth per format

SPECIFICATION	UNIT	HI-MACS® 12MM			HI-MACS® 9MM			HI-MACS® 6MM		
		S028 Alpine White			S028 Alpine White			S028 Alpine White		
Colour		length	width	thickness	length	width	thickness	length	width	thickness
Size Sheet	mm	3048	763	12	3049	764	9	2497	765	6
Size Embossing	mm	3061	771	12,1	3064	769	9,1	2507	771	6,1
Variation	%	0,43	1,05	0,83	0,49	0,65	1,11	0,40	0,78	1,67
Depth Embossing	mm	1,0 - 2,5 mm			1,0 - 2,5 mm			1,0 - 2,5 mm		

The formats can vary slightly due to temperature fluctuations.

## Public Buildings and Offices

The requirements for public spaces are very demanding. It's therefore good to know that HI-MACS® regularly undergoes all of the relevant product tests and holds all the required certificates to prove its superior quality.

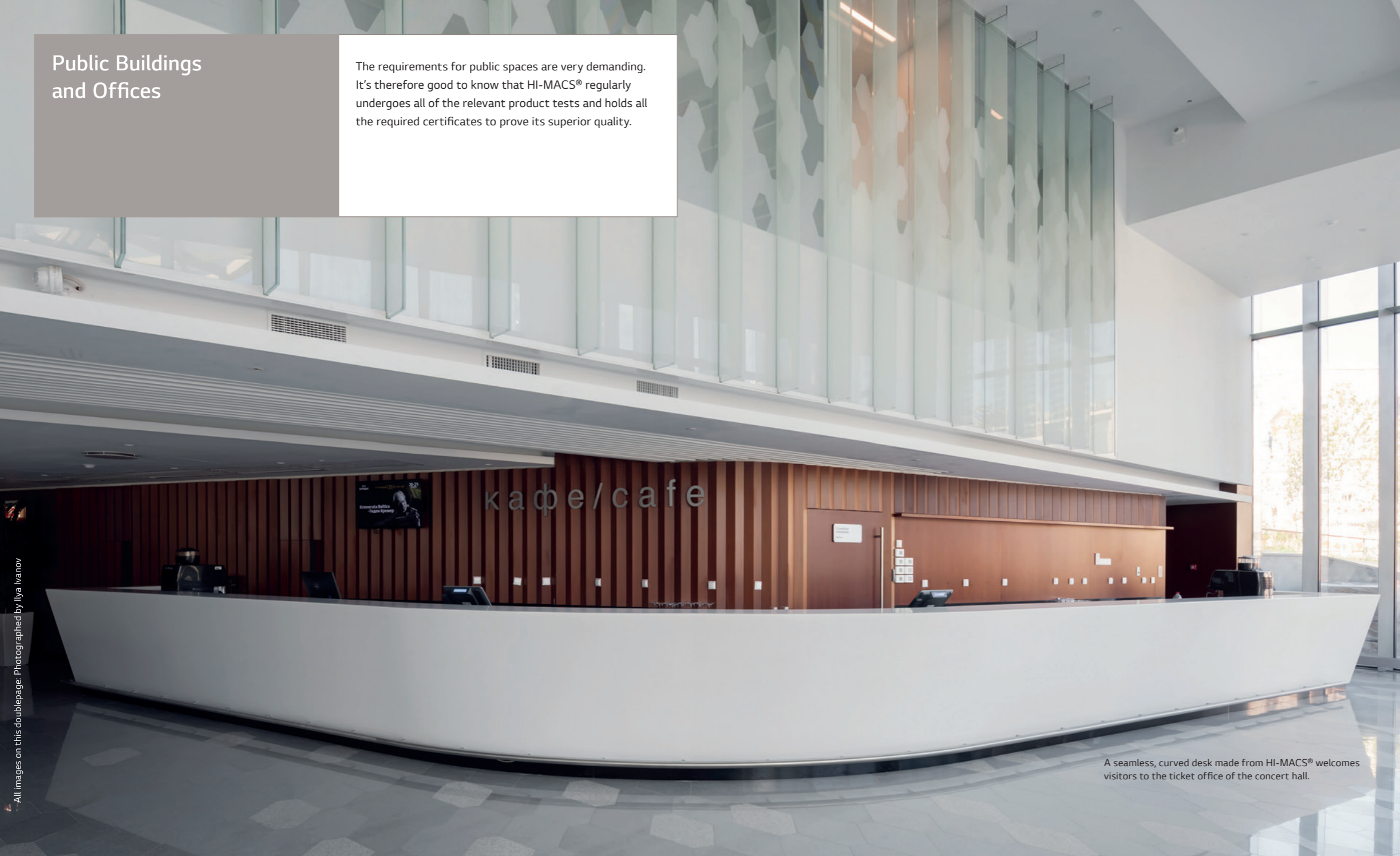

A seamless, curved desk made from HI-MACS® welcomes visitors to the ticket office of the concert hall.

### Moscow Concert Hall "Zaryadye"

Location: Moscow, Russia

Design: TPO Reserve, Russia, reserve.ru/en

Fabrication: Artcor, Russia

Material: HI-MACS®, Diamond White, Black



All images on this doublepage: Photographed by Ilya Ivanov

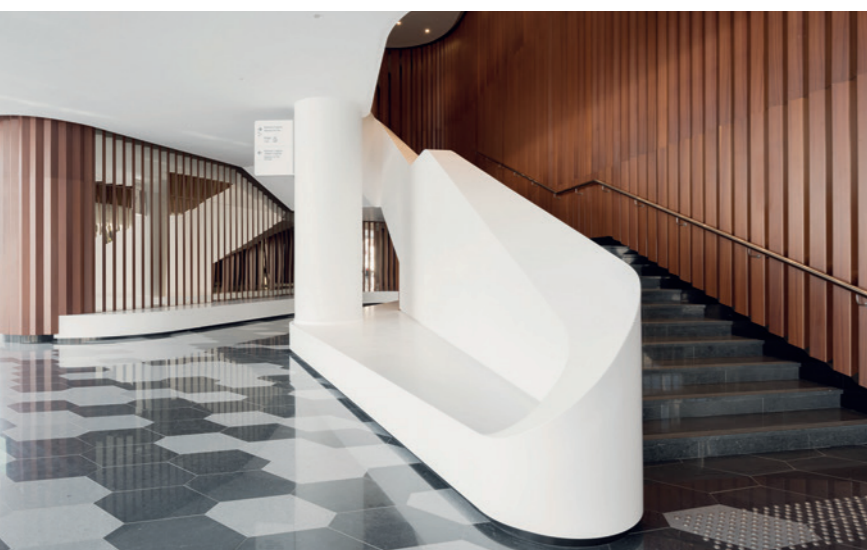

#### The perfect start

Architects succeeded in creating the perfect formal relationship between the building and its contents – the architecture of the concert hall in Moscow feels like a skilfully arranged piece of music. Three main materials that harmonise perfectly: grey granite, dark wood and white HI-MACS®. The stylish highlights – bars, table tops, furniture covers, wardrobes, banisters, wall coverings and ceiling elements – all made from HI-MACS®.

## Kantoor Omega Reizen

Location: Willebroek, Belgium

Design: Boxar Architecten, Belgium, boxar.be

Fabrication: Homescape, Belgium, homescape.be

HI-MACS® Supplier: Engels Design & Decoration, Belgium

Material: HI-MACS®, Alpine White



### Generous and light

This travel agency exudes the vastness and relaxation of a successful holiday. The extensive counters are made as a continuous surface of high-quality HI-MACS®. Clever detail: on the staff side, the cable channels are integrated into the installation, invisible from the customer.



## Star Wars

Location: Trenčín, Slovakia

Design: Schmidt Interier, s.r.o., Nina Porubánová

Fabrication: Dřevovýroba Podzimek s.r.o.

HI-MACS® Supplier: POLYTRADE CE, s.r.o.

Material: HI-MACS®, Alpine White, Black Pearl, Opal, Sapphire



### Star Wars made in HI-MACS®

Incredible, it's possible to create even the craziest idea using HI-MACS® – like this black conference table in Star Wars style with inlaid white decorative stripes. The table's vertical edge is made in translucent Lucent Sapphire – when the light is switched on, the "spaceship" almost seems to levitate.





Key elements in the spacious foyer include the two curved benches made from HI-MACS®, each 6 metres in length.

**Stadtwerke Karlsruhe**

**Location:** Karlsruhe, Germany  
**Design:** Scope Architekten GmbH, Germany, scopeoffice.de  
**Fabrication:** Hasenkopf Industrie Manufaktur GmbH & Co. KG, Germany, hasenkopf.de – Karl Westermann GmbH & Co. KG, Germany, westermann.com/de/  
**HI-MACS® Supplier:** Klöpfer Surfaces, Germany  
**Material:** HI-MACS®, Ivory White, Arctic White, Black Granite

**Open space**

The municipal utility company in Karlsruhe, Germany, has redesigned its administration building into an open-plan design. In the foyer, large pieces of furniture and most of the work surfaces in kitchens and offices are made from HI-MACS®. The staff offices are dominated by 25 benches made from the same material, all of which promote communication, exchange and transparency.



Some of the 25 seat elements and three reception desks are designed so that plants can be added immediately.





## Facades and Wall Cladding

HI-MACS® superior quality makes it ideal for using in cladding projects, facades and wall linings.

All images on this page: Photographed by AEV Architectures



### Sokcho House in White

**Location:** Inheung-ri, Toseong-myeon, Goseong-gun, Gangwon-do, South Korea

**Design:** Woo-jin, LIM AEV Architectures, aev-architectures.com

**Material:** HI-MACS®, Alpine White

At first glance, the silhouette of this house appears to be simple. However it posed a challenge to architects and finishers: the interlocking cubes, some with seamless surfaces, some with distinctive dividing lines, are all made of HI-MACS®.

### The house that plays with light

HI-MACS® has a sensuous way of dealing with light: When used as a facade the material provides great aesthetic properties. The light is absorbed or reflected, depending upon the intensity and angle of incidence, and gives the Sokcho Housing in Alpine White a mystical feel.



### Bieblova Façade

**Location:** Prague, Czech Republic

**Design:** P6PA+Architects, s.r.o., p6pa.cz, Martin Klejna, Javier Navas Fabregat

**Fabrication:** Duolit s.r.o., Atlas Group s.r.o., Dřevovýroba Podzimek s.r.o.

**HI-MACS® Supplier:** Polytrade CE, s.r.o., Czech Republic

**Material:** HI-MACS®, Alpine White

Precise milling, effective back-lighting, near-invisible installation equipment and the robustness of an inner-city facade: HI-MACS® offers all this.



All images on this page: Photographed by Miguel Alonso

### When the facade tells a story

The façade of the Bieblova residence project, built using HI-MACS® Solid Surface, has been designed by P6PA+Architects as a tribute to Konstantin Biebl, a prominent Czech poet from the inter-war period who lends his name to the street in Prague where the building is located.



## Shops and Exhibitions

It is an accepted fact in retail, that no compromises can be made in terms of quality. And HI-MACS® does just what the high-tech brand LG promises. With its limitless possibilities, the material meets the demanding requirements to perfection.



**Exclusive claim meets exclusive realisation**  
High-quality perfumes call for a beautifully presented, elegant environment. The counter made from HI-MACS® looks monolithic but noble at the same time.

### Parfümerie Brückner-Bublitz at the Hirmer Stammhaus

**Location:** Munich, Germany  
**Design:** Hirmer GmbH & Co. KG / Tamara Czech, hirmer-gruppe.de  
**Fabrication:** Kaupp + Diether GmbH, kaupp-diether.de  
**HI-MACS® Supplier:** Klöpfer Surfaces, Germany  
**Material:** HI-MACS®, Taos, Ispani



### Oblique Men

**Location:** Utrecht, The Netherlands  
**Design:** The Invisible Party, theinvisibleparty.com  
**Fabrication:** Van Assem Interieurbouw, vanassem.nl  
**HI-MACS® Supplier:** Baars & Bloemhoff, The Netherlands  
**Material:** HI-MACS®, Emerald

**Charade of light**  
This exotic boutique shows how the counters and presentation furniture in Emerald interact with light. Here, the extreme translucence of HI-MACS® Lucent shows its full strength: the material glows and radiates even when using "normal" incident light.





### Shoppingcity RM Valcea

Location: Ramnicu Valcea, Romania  
 Design: HBRO Architecture/Atvanguard Design Team, Romania  
 Fabrication: Atvanguard, Romania, himacs.ro  
 HI-MACS® Supplier: Atvanguard, Romania  
 Material: HI-MACS®, Alpine White, Black Pearl, Caria, Beach Sand

All images on this page: Photographed by Atvanguard



### Grid Sportswear Shoes

Location: Ploiesti, Romania  
 Design: Pick Two, Romania, picktwo.ro  
 Fabrication: Atvanguard, Romania, himacs.ro  
 HI-MACS® Supplier: Atvanguard, Romania  
 Material: HI-MACS®, Chic Concrete, Pebble Pearl

All images on this page: Photographed by Atvanguard

#### The perfect polyhedron

In geometry a polyhedron is when a body consists of many flat surfaces. In terms of construction, this is extremely difficult to achieve with most materials. However, such geometries are where HI-MACS® really shines: thanks to its high quality and ease of processing, the surfaces can be precisely milled and joined to form the finished article.



#### Consistent branding with luminosity

The logo of the Grid brand stands in the middle of this simple counter in the perfectly symmetrical shop. With its recessed flush design, manufactured in Chic Concrete, and then backlit, the desk is the centre of attention.



## Hospitality and Gastronomy

HI-MACS® creates visual, statement features in the trendiest of bars, the most upmarket of restaurants and the most happening clubs. Especially for internationally operating hospitality chains it is good to know that LG Hausys offers a global after sales service with their network-partners.

### Hotel Kaktus Playa

**Location:** Costa del Maresme, Spain  
**Design:** Byko Projectes i Gestió & Maria Gelpí Interiorism, Spain, byko.es  
**Fabrication:** Lining Time, Spain, liningtime.com  
**HI-MACS® Supplier:** Gabarró, Spain  
**Material:** HI-MACS®, Lunar Sand, Alpine White



### Parc Broekhuizen

**Location:** Leersum, The Netherlands  
**Design:** Judith van Mourik, The Netherlands, [judithvanmourik.nl](http://judithvanmourik.nl)  
**Fabrication:** Not Only White, The Netherlands, [notonlywhite.com](http://notonlywhite.com)  
**Material:** HI-MACS®, Alpine White, Black

**Its elegance is hard to beat**  
The historic building with its high ceilings exudes timeless elegance. The marble background compliments the washbasin and bathtub both made in HI-MACS® to form an almost sculpture-like unit.

### A cozy night's sleep

The idea behind this fascinating design is based on achieving a simple and calm design. Ceiling and wall coverings create a relaxing atmosphere with their softly curved contour elements and perfectly placed effect light.



**Bells Café  
at KPN Amsterdam**

**Location:** Hoofddorp, The Netherlands  
**Design:** Rever Interiorprojects,  
 The Netherlands, rever.nl  
**Fabrication:** Dokter Interieurbouw,  
 The Netherlands, dokterib.nl  
**HI-MACS® Supplier:** Baars & Bloemhoff,  
 The Netherlands  
**Material:** HI-MACS®, Maui



Photographed by Rever Interiorprojecten

**Robust in a lively café operation**  
 The dark green counter is the heart of Bell's Café in Amsterdam, which is busy all day long. An important condition was that the material of choice be extremely resistant and super easy to maintain. HI-MACS®? Check!



Photographed by Ronald Smits

**Greenchoice**

**Location:** Rotterdam, The Netherlands  
**Design:** Colliers International Occupier Services,  
 The Netherlands, colliers.com/nl-nl/netherlands  
**Fabrication:** Hoogendoorn Maritieme betimmeringen en  
 Interieurbouw, The Netherlands, hoogendoorn-mbi.nl  
**HI-MACS® Supplier:** Baars & Bloemhoff, The Netherlands  
**Material:** HI-MACS®, Alpine White



Photographed by Dimitri Janssens

**Toog SCK-VITO**

**Location:** Mol, Belgium  
**Design:** Architects in Motion, Valedro,  
 Belgium, architectsinmotion.be,  
 valedro.be  
**Fabrication:** DWK, Belgium, dwk.be  
**HI-MACS® Supplier:** Engels Design &  
 Decoration, Belgium  
**Material:** HI-MACS®, Alpine White

**Sometimes white, sometimes red,  
 sometimes blue**  
 Modern LED technology and HI-MACS®  
 make this possible. This counter can  
 immerse the entire foyer in different  
 moods: the intelligent lighting uses  
 the high luminosity of the material  
 and benefits from its versatile processing  
 options.



**Greenchoice chooses HI-MACS®**  
 Yes, that can be interpreted as a statement when a supplier of green  
 electricity relies on HI-MACS®. All round café counters and bar elements  
 are made of the material, while the branding board at reception also  
 uses backlit HI-MACS®.

## Healthcare

Cleanliness and sterility are paramount in hospitals and laboratories and any materials used should meet the strictest quality-standards. Its internationally certified resistance to dirt, viruses, bacteria and numerous chemicals makes HI-MACS® the first material of choice in the healthcare sector.



Hygiene can also look good: the curved elements are easy to maintain and great to look at.



### Emergency Hospital Clínic (3rd Floor)

**Location:** Barcelona, Spain  
**Design:** PMMT Arquitectura, Spain, [pmmtarq.com/es](http://pmmtarq.com/es)  
**Fabrication:** Abalit Elementos Moldeados S.L., Spain, [abalit.com](http://abalit.com)  
**HI-MACS® Supplier:** Gabarró, Spain  
**Material:** HI-MACS®, Alpine White



### Perfect impression meets perfect hygiene

If you want to combine maximum aesthetics and functionality in a small space, HI-MACS® is often the first choice. This dental practice in the Swiss St. Gallen relies on the easy-care material in the stylish reception area, and also uses it in the clinical zones in the treatment area.



### Dentist Practice St Gallen

**Location:** St. Gallen, Switzerland  
**Design:** Jeannette Geissmann, Switzerland, [geissmann-arch.ch](http://geissmann-arch.ch)  
**Fabrication:** Keller Züberwangen AG, Switzerland, [kellerzueberwangen.ch](http://kellerzueberwangen.ch)  
**HI-MACS® Supplier:** Kläusler Acrylstein AG, Switzerland  
**Material:** HI-MACS®, Alpine White

### The emergency room is always about maximum performance

A hospital's emergency room can be a turbulent place. Fundamental to this area is perfect hygiene and ease of cleaning. Thanks to its non-porous surface, which prevents liquids from penetrating and the visually seamless joints, dirt, viruses and bacteria, can be controlled.

## Kitchen

The ingredients, as well as the material on which they are prepared, have a key role in creating a high-quality meal. HI-MACS® is a non-porous, dirt-repellent and hygienic surface, and combined with its Thermalcure-technology, results in the best surface-quality for working with food and everyday household chemicals.



### Private Kitchen by Pirkelmann + Schmidt Gbr

**Location:** Munich, Germany  
**Design and Fabrication:** PIRKELMANN + SCHMIDT GbR Möbel- und Küchenmanufaktur, Germany, pirkelmann-schmidt.de  
**HI-MACS® Supplier:** Klöpfer Surfaces, Germany  
**Material:** HI-MACS®, Alpine White

**A cleaning and cooking island**  
Worktops and furniture doors of this premium kitchen are made from HI-MACS®. The generous look meets perfect function here: large, deep HI-MACS® basins are seamlessly integrated into the work surfaces and the hobs are almost flush-mounted: elegant and easy to clean.



The slightly raised edge prevents liquids from dripping down the worktop.

### SOLID/LIQUID Kitchen

**Location:** Eindhoven, The Netherlands  
**Design and Fabrication:** Studio Thier & vanDaalen, The Netherlands, thiervandaalen.com  
**HI-MACS® Supplier:** Baars & Bloemhoff, The Netherlands  
**Material:** HI-MACS®, Arctic White

**Eye-catching Inlay**  
The decorative inlay round the splashback and worktop is made possible by using HI-MACS®. The entire worktop, sink and splashback are made from the material, with a slim spice rack and narrow LED lighting completing the look.

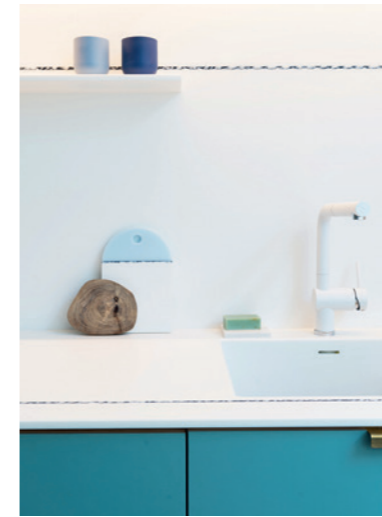

### The Narrow House

**Location:** London, United Kingdom  
**Design:** FORMstudio, United Kingdom, formstudio.co.uk  
**Fabrication:** Hayburn & Co., United Kingdom, hayburn.com  
**HI-MACS® Supplier:** James Latham, United Kingdom  
**Material:** HI-MACS®, Alpine White

**Narrow house with solid kitchen**  
The extraordinary light reflection of the material plays a role, but also the outstanding hygienic properties, which ensure that the material remains brilliant white even in the busiest kitchen.



All work surfaces and legs of the cooking island are made from HI-MACS®.

## Living Spaces

Any materials used within your home should be selected with utmost care as you will be using them for many years. The exclusive 15-year warranty with a Quality Club fabricator ensures that your satisfaction is guaranteed.

If you like it "white" and "bright," HI-MACS® is the perfect answer. The basic colour of this house is "white," and its mood is "flooded with light." The use of materials consistently supports the design concept. All elements are custom-made, demanding maximum flexibility from the material.



### House Timisoara

Location: Timisoara, Romania

Design: Parasite Studio, Romania, [parasitestudio.com](http://parasitestudio.com)

Fabrication: Atvanguard, Romania, [himacs.ro](http://himacs.ro)

HI-MACS® Supplier: Atvanguard, Romania

Material: HI-MACS®, Arctic White



The staircase is made entirely from HI-MACS® – thanks to the slim steps, it looks light and transparent.



The look of this kitchen in Alpine White is created by the graphic lines and the slight slopes, but above all by the skilful use of the flush-mounted LED strip lights.







Perfect for outdoor areas: HI-MACS® is water and weatherproof, while UV radiation won't damage the material.

**HI-MACS® House at Lake Garda**  
 Location: Garda, Italy  
 Design: Dreer-Graf GmbH, Germany, dreer-graf.de  
 Fabrication: Dreer-Graf GmbH, Germany, dreer-graf.de  
 HI-MACS® Supplier: Klöpfer Surfaces, Germany  
 Material: HI-MACS®, Alpine White



Also from HI-MACS®: The wide sliding doors in mosaic look in the basement.



The 4 metre long dining table on the terrace – also made from HI-MACS®.

All images on this double page: Photographed by Melanie Gotschke

**"We knew immediately that HI-MACS® was the perfect material!"**  
 An enthusiastic architect and a happy client, the encouraging results at the end of an ambitious project. This "HI-MACS® house" on Lake Garda uses the material in almost every imaginable spot and thus creates a transparent, simple, yet impressive overall impression.



The pool rim, as well as the circular terracing elements are made from HI-MACS®.



## Bathroom

Thanks to its waterproof surface and the extensive range of high-quality washbasins, HI-MACS® is becoming increasingly popular in the bathroom. The warm, pleasing feel of the material, coupled with its ease of care means HI-MACS® is simply perfect.



### Collection "Uno"

**Location:** Burriana, Castellón, Spain

**Design:** Sanycces design Office, Spain, sanycces.es

**HI-MACS® Supplier:** Gabarró, Spain

**Material:** HI-MACS®, Alpine White

**HI-MACS®, wood and minimalism equal to Uno**

The optimal combination with other high-quality and "warm" materials as well as the minimalistic design options were the reasons why the designers of the Sanycces Group chose HI-MACS®. The hygienic quality of the material ensured that HI-MACS® became the main material of the first "Private Bathroom Collection" for the 25-year-old company.



### If size is the main problem

For bespoke dimensions to be created, HI-MACS® offers a decisive advantage: pieces for bathrooms can either be chosen from the extensive product range or individually made to your own specification, such as these large hand basins in a private bathroom.

### Pure & white

**Location:** Schilde, Antwerpen, Belgium

**Design:** QTD Interieurarchitecten & lifestyle, Belgium, qtd.be

**Fabrication:** Meubelmakerij Ceulemans, Belgium, meubelmakerijceulemans.be

**HI-MACS® Supplier:** Engels Design & Decoration, Belgium

**Material:** HI-MACS®, Alpine White

### Renovatie Villa

**Location:** Schilde, Antwerpen, Belgium

**Design:** Martine Geusens, Belgium

**Fabrication:** Meubelmakerij Ceulemans bvba, Belgium, meubelmakerijceulemans.be

**HI-MACS® Supplier:** Engels Design & Decoration, Belgium

**Material:** HI-MACS®, Lunar Sand

### Perfect fit

Renovating means making the most of existing conditions. In this case, the result is more than convincing. The all-round installation with washbasin, furniture fronts, wall and niche cladding, and window surrounds is entirely from HI-MACS®.



## Furniture Design

Whether it is used for hexagonal tables with internal lighting, honeycomb-shaped shelving, engraved counters or thermoformed seating, HI-MACS® provides limitless design options and maximum material quality.



### Nomad

**Location:** Newcastle, United Kingdom  
**Design:** Felix Smith, felixsmithdesign.com  
**Fabrication:** Raskl Studio + Workshop, United Kingdom, Raskl.co.uk  
**HI-MACS® Supplier:** James Latham, United Kingdom  
**Material:** HI-MACS®, Sapphire

#### Bench and table to go

The young designer, Felix Smith, relies completely on our high-tech material: "I love HI-MACS® because of its excellent surface, which is extremely robust. It feels like stone and can be processed like wood in large quantities."



### Domino Light

**Location:** London, United Kingdom  
**Design:** Glithero, United Kingdom, glithero.com  
**Fabrication:** MCD Marketing, United Kingdom, mcdmarketing.co.uk  
**Material:** HI-MACS®, Dark Night, Copper, light bulb

#### Lamp with wow effect

The case made from HI-MACS® in the colour Dark Night forms the basis of this exciting lamp. Once the copper dominoes have all fallen, the circuit closes, and the light turns on.



### L'éclat du vigneron

**Location:** Warmeriville, France  
**Design:** Geoffrey Martin, France  
**Fabrication:** L'Artelier, France, l-artelier.fr  
**HI-MACS® Supplier:** Aska interior, France  
**Material:** HI-MACS®, Alpine White

#### The wine cooler from another dimension

Designed for elegant occasions, eight champagne bottles can be cooled in this magnificent bottle holder.

## Airport

Desks, counters and shelving at airports are exposed to extremely heavy and constant use. It is here that the perfect finish of HI-MACS® comes into its own – easy to clean and extremely robust, thanks to its innovative Thermalcure-technology.



The amorphous shape of the furniture is possible thanks to the three-dimensional formability of HI-MACS®.

### Frankfurt Airport Terminal 1

**Location:** Frankfurt, Germany  
**Design:** 3deluxe transdisciplinary design, Germany, 3deluxe.de  
**Fabrication:** Georg Ackermann GmbH, Germany, ackermannmbh.de  
**HI-MACS® Supplier:** Klöpfer Surfaces, Germany  
**Material:** HI-MACS®, Alpine White

#### Seating and table sculptures on the roof of the airport

The outdoor furniture at Terminal 1 of Frankfurt Airport was designed by 3deluxe designers, who are known for their design of the legendary Leonardo Glass Cube. Here too the excellent suitability for outdoor use and the outstanding design quality of HI-MACS® were decisive in the selection of materials.



## Outdoor

Materials used outside are exposed to the weather all year round. This means exposure to sun and rain, snow and ice, lots of moisture and different temperatures as well as strong UV rays. HI-MACS® has passed all the required tests in a selection of colours, and has proved its outstanding qualities can master the toughest outside conditions.

### Terrace Artistjok

Location: Nieuwpoort, Belgium

Design: Atelier Artisjok Bvba - Peter Duerinck, Belgium, atelierartisjok.be

Fabrication: L+A Projects, Belgium, laprojects.be

HI-MACS® Supplier: Engels Design & Decoration, Belgium

Material: HI-MACS®, Ivory White, Black Granite

#### Roof terrace with wellness factor

This roof terrace is wonderful – the large hot tub, the lounging area and the outdoor shower all come together to create a feeling of relaxation. HI-MACS® is a lovely tactile material, and totally weather-resistant, so perfect for outdoor areas.



#### This Eco City Garden is a real winner.

The Chelsea Flower Show honours outstanding design projects. The Eco City Garden – designed by Korean landscape architect by Joung Hwang – was awarded a Silver Gilt Award for its beauty and high quality. The garden is full of great, innovative ideas, including HI-MACS®, where the material harmonises perfectly with the natural ambience of the garden.

### Chelsea Flower Show

Location: London, United Kingdom

Design: Hay Joung Hwang, United Kingdom, haydesigns.co.uk

Fabrication: Alan Hayward Joinery Ltd

Material: HI-MACS®, Concrete Collection



## Education

HI-MACS® extreme toughness and ease of maintenance are prerequisites to withstand everyday life in nursery schools, schools, universities and other institutions.

## Marine Industry

A new composition of HI-MACS® from the Hightech laboratories of LG has been developed for use in ship-building. HI-MACS® FR, has been awarded the IMO certificate module B and D in compliance with the Marine Equipment Directive for its fire resistant and fire-retardant properties.

### Dundee Science Centre

Location: Dundee, United Kingdom

Design: Aim Design, Scotland, [aimdesign.co.uk](http://aimdesign.co.uk)

Fabrication: Elmwood Projects Ltd, United Kingdom, [elmwoods.com](http://elmwoods.com)

HI-MACS® Supplier: James Latham, United Kingdom

Material: HI-MACS®, Alpine White



The column elements made of HI-MACS® with integrated displays are combined with fascinating lighting effects for an inspiring display.

### The fascination of "Science"

The science centre in Dundee, Scotland, is designed to create interest among young people in the natural sciences. All displays used must best support this goal. The fascinating effect of HI-MACS® helps a lot here – spherical backlit, three-dimensionally shaped, flush-mounted, the high-tech material arouses the interest of young researchers.



### MS Amadea

Location: Hamburg, Germany

Design: Phoenix Reisen GmbH, Germany, [phoenixreisen.com](http://phoenixreisen.com)

Fabrication: 2 Pier GmbH – Holztec Innenausbau GmbH, Germany, [2pier.de](http://2pier.de) – [tb-berndt.de](http://tb-berndt.de)

HI-MACS® Supplier: Klöpfer Surfaces, Germany

Material: HI-MACS®, Alpine White, Arctic Granite

### At home on the high seas

HI-MACS® brings class and spaciousness to the bathroom design of the ship's cabins on the MS Amadea. The choice of a material makes a very clear statement about how one views quality.



## Best of the Last Decade

In recent years HI-MACS® has been specified more and more by architects and designers – only the best quality can convince demanding clientele like these. Thanks to their ability and talent and to the superior quality of material and fabrication some masterpieces have been achieved with HI-MACS®. Although not recent, they still inspire users and owners. A selection can be found here.



### Händel House

**Location:** Halle, Germany

**Design:** Gerhards & Glücker, Germany, gerhardsgluecker.com

**Fabrication:** Möbel Damm, moebel-damm.de

**Material:** HI-MACS®, Arctic White

#### Baroque forms to honour a baroque musician

This building to honour the great musician Georg Friedrich Händel transitions from an understated exhibition and reception area to an opulent Baroque hall. HI-MACS® links and enables both: the ornamental splendour as well as the subtle play of lights.

### Hotel Puerta America

**Location:** Madrid, Spain

**Design:** from left to right: Christian Liaigre, France – Ron Arad, UK – Zaha Hadid Architects, UK – christian-liaigre.fr, ronrad.co.uk, zaha-hadid.com

**Material:** HI-MACS®, Alpine White, Black, Fiery Red

#### 19 well-known architects and designers designed this hotel – naturally using HI-MACS®

The result of their work is simply breathtaking, with every room being a veritable stand-alone masterpiece. HI-MACS® was with them every step of the way – inspiring the designers to create their most daring designs.



### Atlas Swimming Pool

**Location:** Paris, France

**Design:** Yonseux Architectes, France, yonseux.com

**Fabrication:** ASKA Interior, France, aska-interior.com

**Material:** HI-MACS® Arctic White

#### Water and HI-MACS® do mix

This indoor swimming pool in a Parisian school was designed mainly with HI-MACS®: parts of the exterior walls, the geometrical relief on the interior walls, the non-slip floor in the shower area and many individual items of furniture were all created in HI-MACS® Arctic White. Its perfect hygiene and ultra-flexible form are important properties of the material, which also gives the space a unique atmosphere.

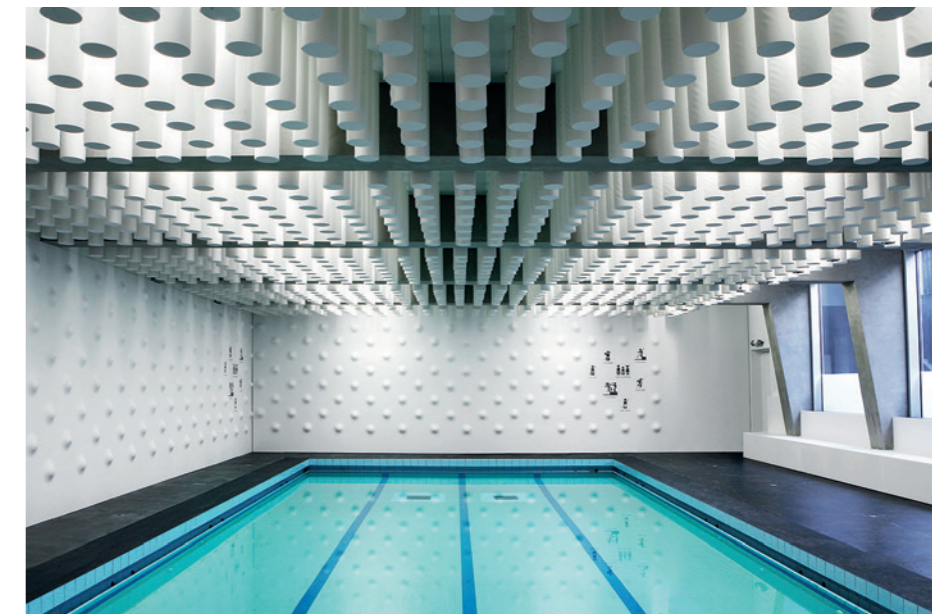

### Raiffeisen Bank Zürich

**Location:** Zürich, Switzerland

**Design:** NAU Architecture, Switzerland, Drexler Guinand Jauslin Architekten, Switzerland, nau.coop, dgj.ch

**Fabrication:** Wallcovering patterns design: ROK, Rippmann Oesterle Knauss, Switzerland, rok-office.com – Wallcovering and joinery: Glaeser Baden, Switzerland, glaeser.ch

**Material:** HI-MACS®, Alpine White

#### HI-MACS® helps create a personal vision

The Raiffeisen Bank in Zurich displays the portraits of former prominent residents that stand out thanks to the intricate cutting of triangles of different sizes and the spartan overall interior architectural design.



### Showroom ALV

**Location:** Milan, Italy

**Fabrication:** Flusso, Facchinetti Group

**Material:** HI-MACS®, Ivory White

#### Handbags and gladrags

The central and pivotal element in this showroom is a circular filigree skeleton made of HI-MACS® that showcases the fashionable accessories.



We have a strong partner network for your most creative ideas.

Architects and designers have awe-inspiring ideas. And exceptional craftsmen transform them into reality using HI-MACS®.

Contact us to find our network of exclusive distributors serving more than 5.000 fabricators across Europe and our numerous Quality Club Training Centres. This is our strategy to guarantee the best quality at all levels.

We can also offer you the security of our global LG After-sales Service with our experienced HI-MACS® experts all around the world.

All contact details of our network can be found at

**himacs.eu**

Because Quality Wins.

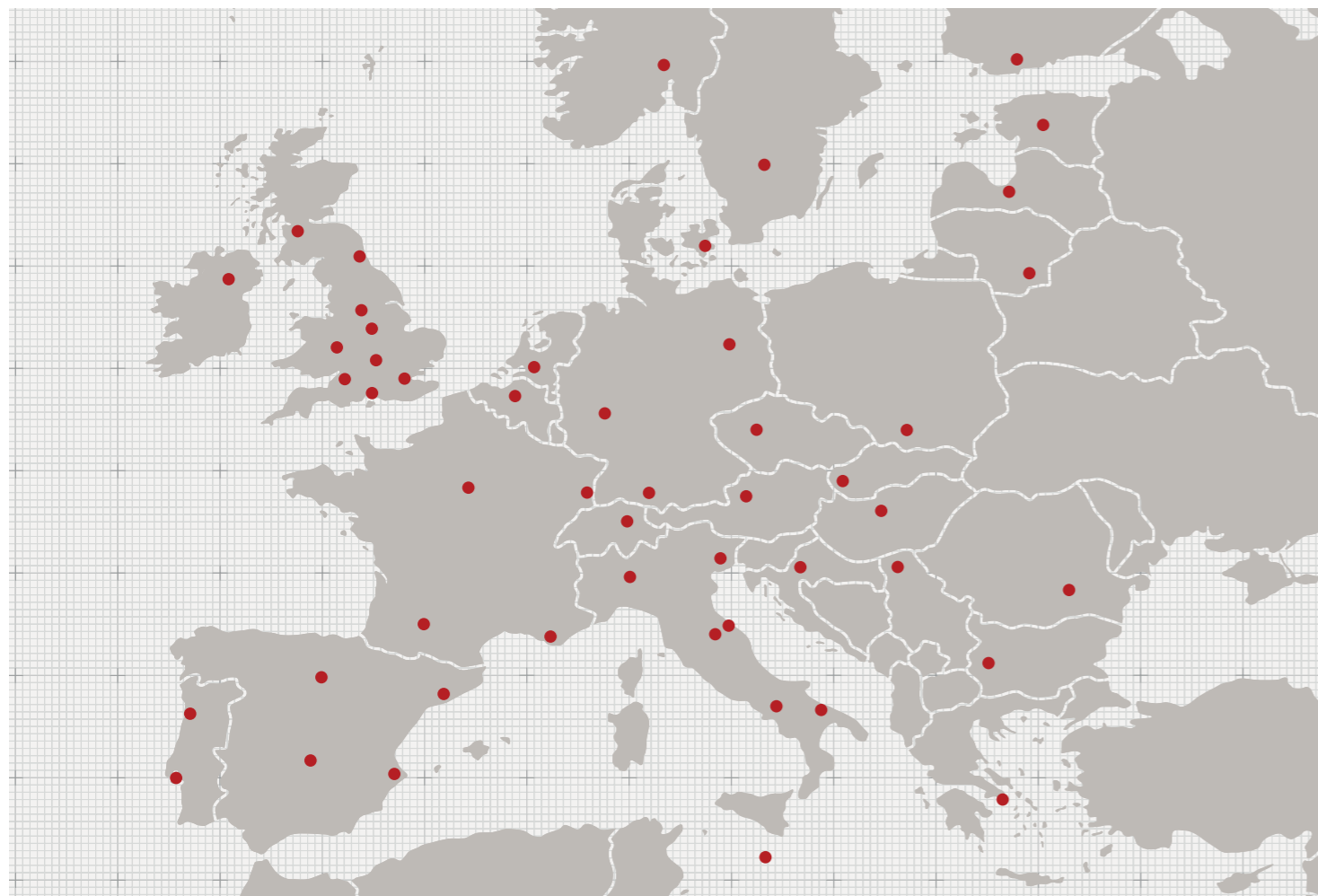

**PRODUCT SPECIFICATION**

The perfect basis for your ideas: our comprehensive range of sheets.

New sheet thickness **20mm!** (previously 19mm)

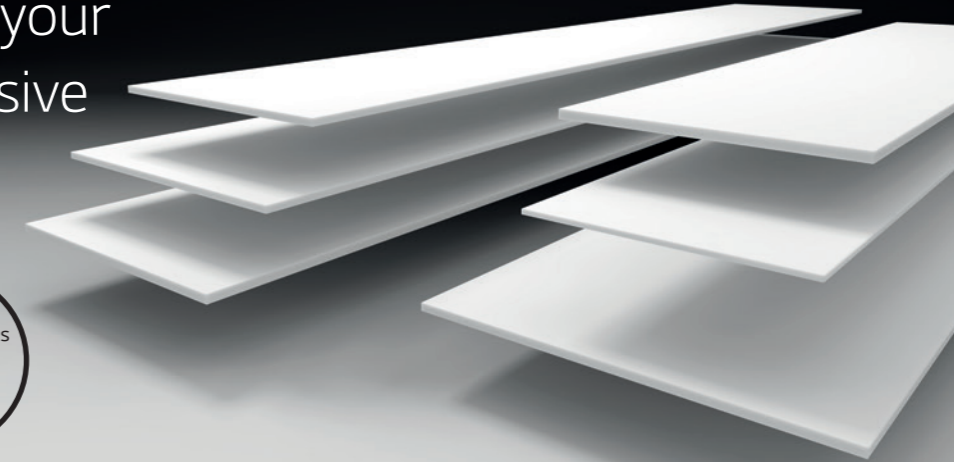

**Standard Formats**

- 760 x 2490 mm
- 910 x 2490 mm
- 760 x 3000 mm
- 930 x 3000 mm
- 1350 x 3000 mm
- 1350 x 3050 mm
- 760 x 3680 mm
- 910 x 3680 mm
- 1350 x 3680 mm
- 1520 x 3680 mm

**Sheet Material**

- HI-MACS® is available in different thicknesses, formats and sizes. Perfect for maximum cutting and minimal costs. However, not all colours are available in every thickness. See the table for availability below.
- HI-MACS® sheet material is available in thicknesses of 3 mm, 4 mm, 6 mm, 9 mm, 12 mm and 20 mm as well as the corresponding sheet formats.
- In addition to the standard quality, LG Hausys also offers three specialist compositions (see page 67) available in limited dimensions and colours:

**HI-MACS® FR - Low flammability:** The fire-resistant FR version is available in S728 Alpine White and complies with the requirements of the IMO standard modules B + D and M1. This quality is particularly suitable for use in public buildings, façades and shipbuilding.

**HI-MACS® Ultra-Thermoforming:** This special formulation can be formed into very small radii (up to 6 mm radius) (see page 19)

**HI-MACS® Structura:** Here you can choose from the standard range of 10 haptic patterns or develop your own structured designs (see pages 22-24).

**Dimensions – Sheet material**

**Standard Format**

SHEET THICKNESS IN MM	SHEET WIDTH IN MM	SHEET LENGTH IN MM
3	930	3000 *
4	1350	3000 *
6	760	2490
6	910	2490 *
6	1350	3680*
9	760	3680
9	910	3680 *
9	1350	3680 *
12	760	3680
12	910	3680 *
12	1350	3680 *
12	1520	3680 *
20	760	3000 *

**Special Format**

SHEET THICKNESS IN MM	SHEET WIDTH IN MM	SHEET LENGTH IN MM
4	1520	3000 *
6	910	2490 **
6	1520	3680 *
9	910	3680 **
9	1520	3680 *
12	910	3680 **
20	760	3000 ***
20	760	3680 ****

**Ultra-Thermoforming Format \*\*\*\*\***

SHEET THICKNESS IN MM	SHEET WIDTH IN MM	SHEET LENGTH IN MM
12	760	3680
12	910	3680
12	930	3680

\* Only available in S028 Alpine White.  
 \*\* Only available in S006 Arctic White.  
 \*\*\* Available in all colours except for Eden, Marmo Collection and M551 Chic Concrete, M552 Shadow Concrete and M553 Ebony Concrete from Concrete Collection.  
 \*\*\*\* Only available in Solid Colours  
 \*\*\*\*\* Ultra-Thermoforming is only available in S929 Alpine White  
 Special format available on special request, minimum quantities apply.

# Chemical and Technical Information

Over 20 years research and development by LG engineers, means that we are producing high-tech quality products.

Thanks to the new Thermalcure-technology, developed by LG, HI-MACS® performs better than the standard in Solid Surface.

For example you save precious time because it is easier to sand.

And thanks to the Thermalcure-technology used during production, HI-MACS® has excellent heat-resistance.

## Chemical resistance

HI-MACS® is a fully homogenous material with no pores and is thus simple and easy to clean.

CLASS	STAINING AGENT	APPLICATION TIME	EVALUATION OF G002 CHANGES	EVALUATION OF S028 CHANGES
GROUP 1	Water	16h – 24h	5 to 4	5 to 4
	Toothpaste			
	Hand cream			
	Natural fruit and vegetable juice			
	Lemonade and fruit drinks			
	Meats and sausages			
	Animal and vegetable fats and oils			
	Yeast suspension in water			
	Salt (NaCl) solutions			
	Mustard			
	Lyes, soap solutions			
	Cleaning solution			
	Alcoholic beverages			
	Phenol and chloramine-T disinfectants			
Citric acid (10% solution)				
GROUP 2	Coffee (120gr coffee per ltr. water)	16h	5	4 to 5
	Black tea (9gr tea per ltr. water)			
	Milk (all types)			
	Cola beverages			
	Wine vinegar			
	Alkaline-based cleaning agents (10% in water)			
	Hydrogen peroxide (3% solution)			
	Ammonia (10% solution of commercial concentrate)			
	Lipstick			
	Water colours			
	Laundry marking inks			
	Ball point inks			
	*Sodium hydroxide (25% solution)			
	*Hydrogen peroxide (30% solution)			
*Acetone				
Trichloroethane				
Other organic solvents				
Concentrated vinegar (30% acetic acid)				
Bleaching agents and sanitary cleaners containing them				
Hydrochloric acid based cleaning agents				
Tincture of iodine				
Boric acid				
Lacquers and adhesives (except fast-curing materials)				
Amidosulfonic acid descaling agents (≤10% solution)				
Nail varnish				
Nail varnish remover				
Stain or paint remover based on organic solvents				
GROUP 4	*Acetic acid (5% solution)	20min.	5	4

Tests carried out in accordance to EN ISO 19712 for Solid Surface material, please see table (left) for results.



## Evaluation

RATING LEVEL	DESCRIPTION
Rating 5	No visible change
Rating 4	Slight change in gloss and/or colour, only visible at certain viewing angles
Rating 3	Moderate change in gloss and/or colour
Rating 2	Marked change in gloss and/or colour
Rating 1	Surface distortion and/or blistering

a = Acids and alkalis, in concentrations stronger than those shown in group 3, which can be contained in commercial cleaning agents, can cause surface damage or marking, even with very short contact times. Any spillage of such materials should be washed off immediately.

## Technical data sheet

HI-MACS® is extremely resistant to dirt and wear and tear, so that you can enjoy many years', peace of mind with the outstanding quality of your new product.

SPECIFICATION	UNIT	RESULT SOLIDS	RESULT GRANITE	TEST METHODS
Flexural-E-modulus	MPa	8900	7730	DIN EN ISO 178
Flexural strength	MPa	70.1	64.3	ASTM D638
Breaking elongation	%	1	1.1	DIN EN ISO 178
Tensile strength	MPa	69.5	56.3	DIN EN ISO 527
Density	g/cm <sup>3</sup> kg/m <sup>3</sup>	1.75 1750	1.65 1650	ISO 1183 ISO 1183
Ball indentation hardness	N/mm <sup>2</sup>	257	239	DIN EN ISO 2039-1
Mohs hardness		2 to 3	2 to 3	EN 101
Pencil hardness		>9H	>9H	ISO 15184
Water absorption weight strength/thickness		<0,1% <0,1%	<0,1% <0,1%	DIN EN 438 Part 12
Impact resistance impactor drop ball test (fall height)	N mm	≥25 ≥1500	≥25 ≥1500	E DIN EN 438, 02/02 Part 2/20 E DIN EN 438, 02/02 Part 2/21
Slip resistance		>0,32 – 0,9		GMG100 (replaces R9)
Slip resistance		angle of acceptance of more than 10° to 19° = R10		DIN 51130
Climate change resistance	°C	≥0,05	≥0,05	AMK
Dry heat (pan base)	°C	≥100 (7C)		DIN 68 861, Part 7, 04-'85
Damp heat (pan base)	°C	≥100 (7C)		DIN 68 861, Part 8, 04-'85
Temperature change resistance	°C	no change		UNI 9429
Resistance to cigarette burns		6C	6B	DIN 68 861, Part 6, 11-'82
Scratch resistance		4D	4B	DIN 68 861, Part 4, 11-'81
Electrostatics Conductivity	>1x10 <sup>12</sup> Ω	insulating non-conductive		DIN IEC 1340-4-1, 04-'92 EN 61340-5-1
Thermal conductivity	W/mK	0.636	0.55	DIN EN 12664
Thermal resistance	m <sup>2</sup> K/W	0.038	0.045	DIN EN 12664
Thermal expansion co-efficient	mm/mK m/m/°C	0.048 30.0 x 10 <sup>-6</sup>	0.055	DIN EN 14581
Water vapor transmission properties – diffusion resistance factor	μ	18607	16150	DIN EN ISO 12572
Dimensional change by change in relative humidity length thickness mass	% % %	-0.03 0.06 0.05	-0.02 0.03 0.05	DIN EN 318, edit. 5, 1998
Resistance to boiling water increase in weight increase in thickness	% %	<0,1 <0,1	>0,1 <0,1	E DIN EN 438, 02/02 Part 2/12
Light fastness (Xenon)	scale 0 – 10	better than 6	better than 6	DIN 53 387, 04-'89
Food tolerance		suitable for all colours		LMBG § 31
Hygiene		suitable	suitable	LGA Hygiene Certificate
Fire protection classification Flame-retardant properties HI-MACS® MPA/NRW (BAM) 12 mm (BAM) 9 mm + back-up (Bodycote/Warrington) 12 mm		B1  non-dripping material B1 for all colours* B1 for all colours* B-s1, d0 for all HI-MACS® colours* complies with BS 476 class 0	B1	DIN 4102-1  DIN 5510  DIN 4102-1 BS EN ISO 11925-2 : 2002 BS EN 13823: 2002

\* not currently applicable to Marmo, Galaxy, Volcanics, Lucent and Eden



# Colours

Colours are key in design. Elegant Nordic White, warm Toffee Brown or mystical Cima. We have virtually any colour you could wish for.











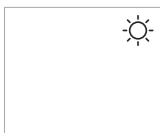
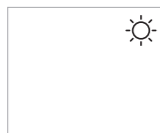
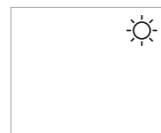

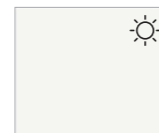
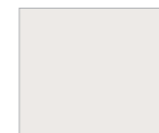

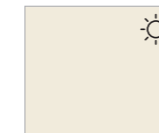
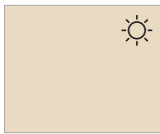











## Extra service on demand

If needed, LG Hausys Europe can produce different dimensions and bespoke colours. To learn more about the conditions, please contact us at [himacs.eu](mailto:himacs.eu)

**BIM OBJECTS**  
available at [himacs.eu](http://himacs.eu)

## Solids



From elegant to extravagant, classic to ultra-contemporary.

							
Alpine White S028 [20/12/9/6/4/ 3 mm] Δ E5	Nordic White S033 [20/12 mm] Δ E5	Diamond White S034 [20/12 mm] Δ E5	Arctic White S006 [20/12/9/ 6 mm]	Ivory White S029 [20/12/9/ 6 mm] Δ E5	Nougat Cream S201 [20/12 mm]	Satin White S001 [20/12/9/ 6 mm]	Cream S009 [20/12/6 mm] Δ E5
							
Almond S002 [20/12 mm] Δ E5	Babylon Beige S102 [20/12 mm]	Toffee Brown S104 [20/12 mm]	Suede S121 [20/12 mm]	Grey S005 [20/12/9/ 6 mm]	Marta Grey S108 [20/12 mm]	Steel Grey S109 [20/12 mm]	Concrete Grey S103 [20/12 mm]
							
Lemon Squash S106 [20/12 mm]	Banana S026 [20/12 mm]	Orange S027 [20/12 mm]	Fiery Red S025 [20/12 mm]	Festival Pink S116 [20/12 mm]	Light Green S212 [20/12 mm]	Sky Blue S203 [20/12 mm]	Evergreen S119 [20/12 mm]
							
Deep Indigo S115 [20/12 mm]	Cosmic Blue S120 [20/12 mm]	Midnight Grey S117 [20/12 mm]	Mink S118 [20/12 mm]	Dark Night S111 [20/12 mm]	Coffee Brown S100 [20/12 mm]	Black S022 [20/12/9 mm]	

20 mm: S028 Alpine White available in stock. All other colours on special request, except for Chic Concrete, Shadow Concrete, Ebony Concrete and Marmo Collection.



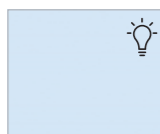

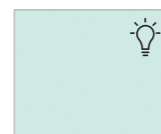
## Lucent

When combined with precisely positioned light sources, the translucent pastel shades become transformed into dramatic design "highlights".

			
Opal S302 [20/12/6 mm] Δ E5	Sapphire S303 [20/12 mm]	Ruby S304 [20/12 mm]	Emerald S305 [20/12 mm]

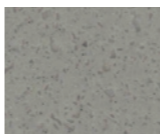

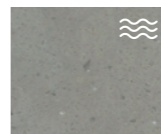





## Concrete Collection

Warm tone, concrete-like finishes are now available in the solid surface material, providing completely new opportunities for architects and designers.

				
Urban Concrete G554 [20/12/9/ 6 mm]	Steel Concrete G555 [20/12/9/ 6 mm]	Chic Concrete M551 [12 mm]	Shadow Concrete M552 [12 mm]	Ebony Concrete M553 [12 mm]

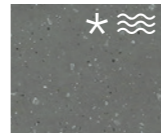

## Marmo

Captivating random veined texture, reminiscent of marble.

				
Breeze White M306 [12 mm]	Ispani M428 [12 mm]	Bellizzi M427 [12 mm]	Cremona M422 [12 mm]	Terni M201 [12 mm]
				
Edessa M501 [12 mm]	Laviano M426 [12 mm]	Naples M904 [12 mm]	Capri M303 [12 mm]	Monza M206 [12 mm]



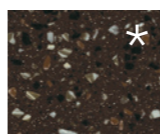
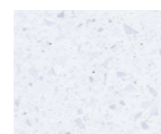
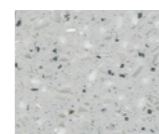
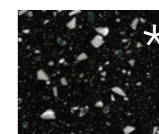

## Lucia

Natural trendy colours characterised by linear-edged, midsize particles: three of these are designed by Dutch Star Designer, Marcel Wanders.

		Three colours designed by Marcel Wanders:				
Lentil W007 [20/12 mm]	Red Quinoa W010 [20/12 mm]		Ice Queen W001 [20/12 mm]	Shadow Queen W003 [20/12 mm]	Star Queen W004 [20/12 mm]	

## Volcanics

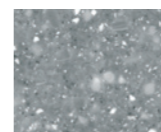
Full of depth and mysticism, akin to a precious natural stone but with all of the advantages of "Natural Acrylic Stone™".

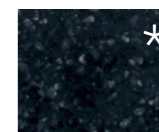
					
Gemini VW01 [20/12 mm]	Tambora VE01 [20/12 mm]	Santa Ana VA01 [20/12 mm]	Frosty VA22 [20/12 mm]	Maui VG21 [20/12 mm]	Cima VB02 [20/12 mm]

## Aster (Galaxy)

With transparent grains and mother of pearl shimmer.

					
Nebula T010 [20/12 mm]	Andromeda T017 [20/12 mm]	Carina T018 [20/12 mm]	New Moon T019 [20/12 mm]	Venus T011 [20/12 mm]	Hercules T020 [20/12 mm]

## Granite, Sparkle, Quartz, Sand & Pearl

A huge selection of textures and colours. Natural, elegant and perfect in combination.

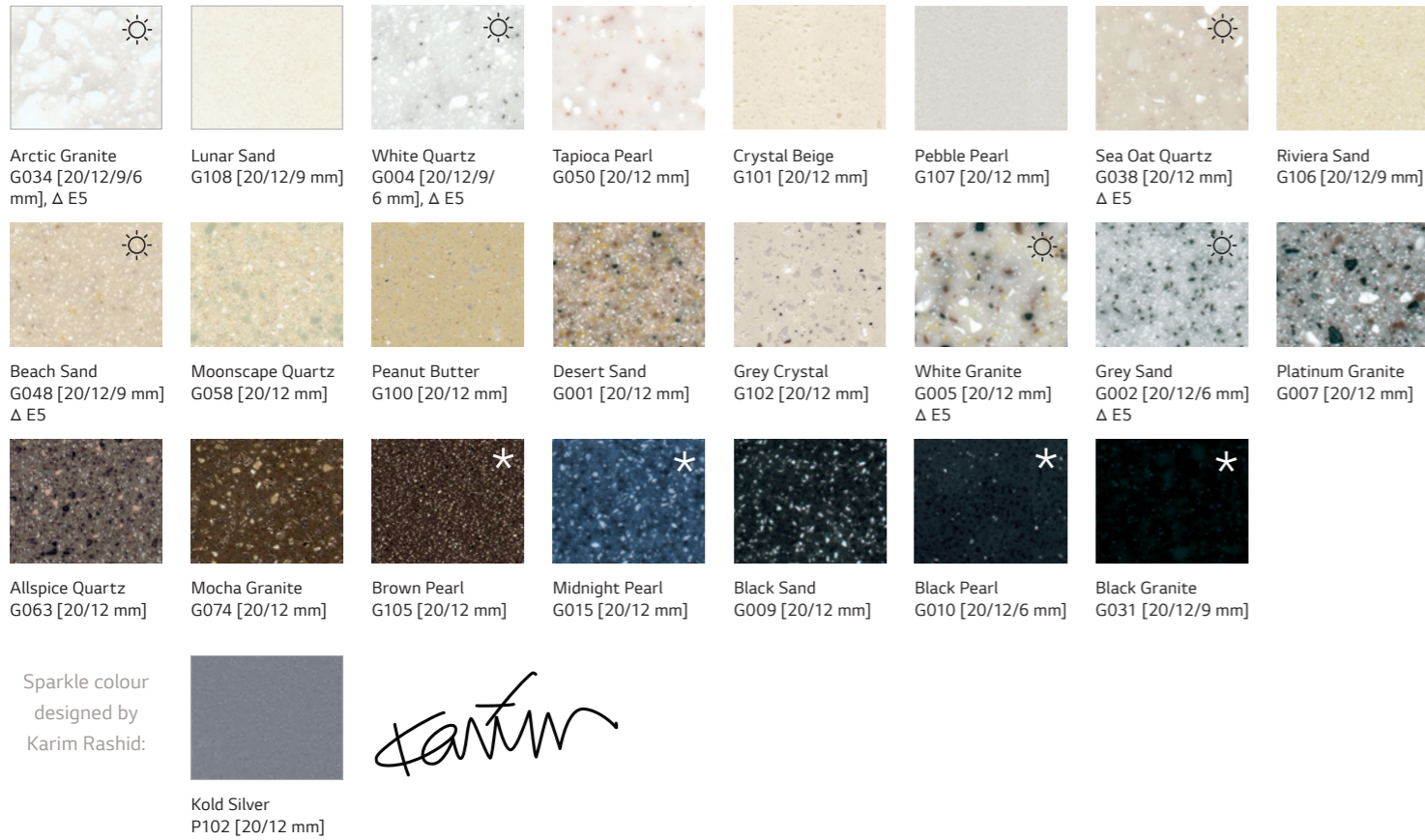

## Eden

A one-of-a-kind palette with warm natural shades and various grain sizes. What makes the collection unique: it consists of up to 35% recycled materials.

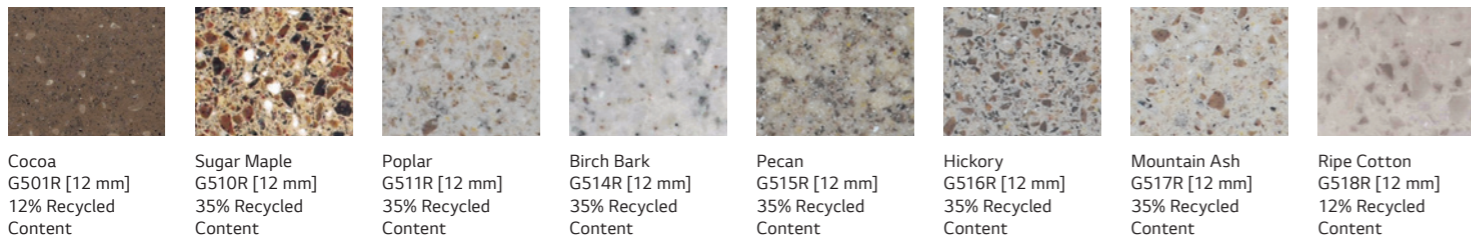

The Eden collection is available upon special request.

## Scoring eco-credits across the board.

The LEED (Leadership in Energy and Environmental Design) seal is a proven classification system for ecological, resource-saving and sustainable construction. The credit-based certification process rates buildings according to different criteria. Opting for HI-MACS® Eden in new construction and renovation projects may provide up to 2 credits in the following LEED categories:

★ **Notice Colours:** The basic HI-MACS® material is identical for every colour but it is important to note that darker and more heavily pigmented colours will show dust, scratches, haziness, marks left by hard water and other ordinary wear and tear more noticeably than lighter textured colours. Therefore colours marked with a ★ are less suitable for applications that are exposed to extensive surface contact such as worktops located in heavy traffic area.

There may be deviations between the illustrated and actual colours owing to printing techniques. To receive the detailed colour range, please contact us at [himacs.eu](http://himacs.eu).

### Indoor Environmental Quality (IEQ)

LEED IEQ 4.1: low-emission materials, adhesives and sealants (1 credit)

### Materials & Resources (MR)

LEED MR 4.1: materials with more than 10% recycled content (1 credit)

LEED MR 4.2: materials with more than 20% recycled content (2 credits)

☀ Some HI-MACS® colours are particularly suitable for outdoor applications because of their good UV-resistance. HI-MACS® offers a 10 Year Warranty on colours' UV resistance and loss of gloss over 40%, 10 Year Warranty on colour leaching and 20 Year Warranty on colour peeling, swelling or delaminating. The warranty is applicable after the first installation and is only valid for the sheet material; adhesives are excluded. The conditions for this warranty are based on practical experience and on-going tests.

≡ Marmo is a randomly veined product, specific fabrication guidelines need to be followed. Ask your sales partner for more information or visit [himacs.eu](http://himacs.eu).

💡 Lucent colours have a higher level of translucency, more evident when combined with light sources.

## The HI-MACS® sheet range for special applications

The ability to use HI-MACS® in high-quality interior design is growing thanks to our wide range special application sheets. Projects with special tendering criteria and challenging design requirements can now be considered.

### HI-MACS® FR – Minimal flammability

The HI-MACS® FR quality with reduced flammability is currently available in Alpine White S728 from the Solid Collection.

HI-MACS® FR has the fire protection classification "B-s1-d0" according to EN 13501 (Single Burning Item test (SBI test))\*.

Fixed in place with KEIL anchors and a BWM construction, the HI-MACS® façade in S728 – Alpine White successfully passed the ETA tests (European Technical Agreement).



Alpine White S728 [12 mm] Δ E5

### HI-MACS® Ultra-Thermoforming

HI-MACS® Ultra Thermoforming sheets are currently available in Alpine White S928 from the Solid Collection. For more information on the design possibilities of HI-MACS® Ultra Thermoforming products, see page 19.



Alpine White S928 [12 mm]

### HI-MACS Structura®

HI-MACS® Structura® sheets are currently available in the following colours from the Solid Collection. The range of structures and individual design options can be found on pages 22 to 24.

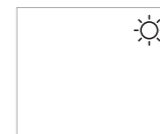

Nordic White S033 [12 mm] Δ E5



Alpine White S028 [12/9/6 mm] Δ E5



Diamond White S034 [12 mm] Δ E5

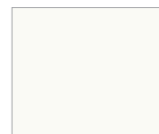

Arctic White S006 [12 mm]

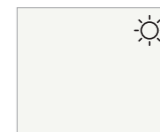

Ivory White S029 [12 mm] Δ E5

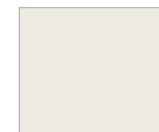

Satin White S001 [12 mm]

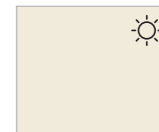

Cream S009 [12 mm] Δ E5



Grey S005 [12 mm]



Fiery Red S025 [12 mm]



Black S022 [12 mm]

HI-MACS Structura® Hive and Elements are not available in Fiery Red and Black.

# Sinks.

## Spacious and elegant.

### HI-MACS® Sinks for kitchen and healthcare applications

Spaciousness, durability and hygiene are all key quality features when choosing a sink for the kitchen or healthcare facility. The top quality models in the HI-MACS® range offer it all. These coordinated sinks are installed as undermounted creating extremely hygienic sink areas. Special custom-made creations are also an option.

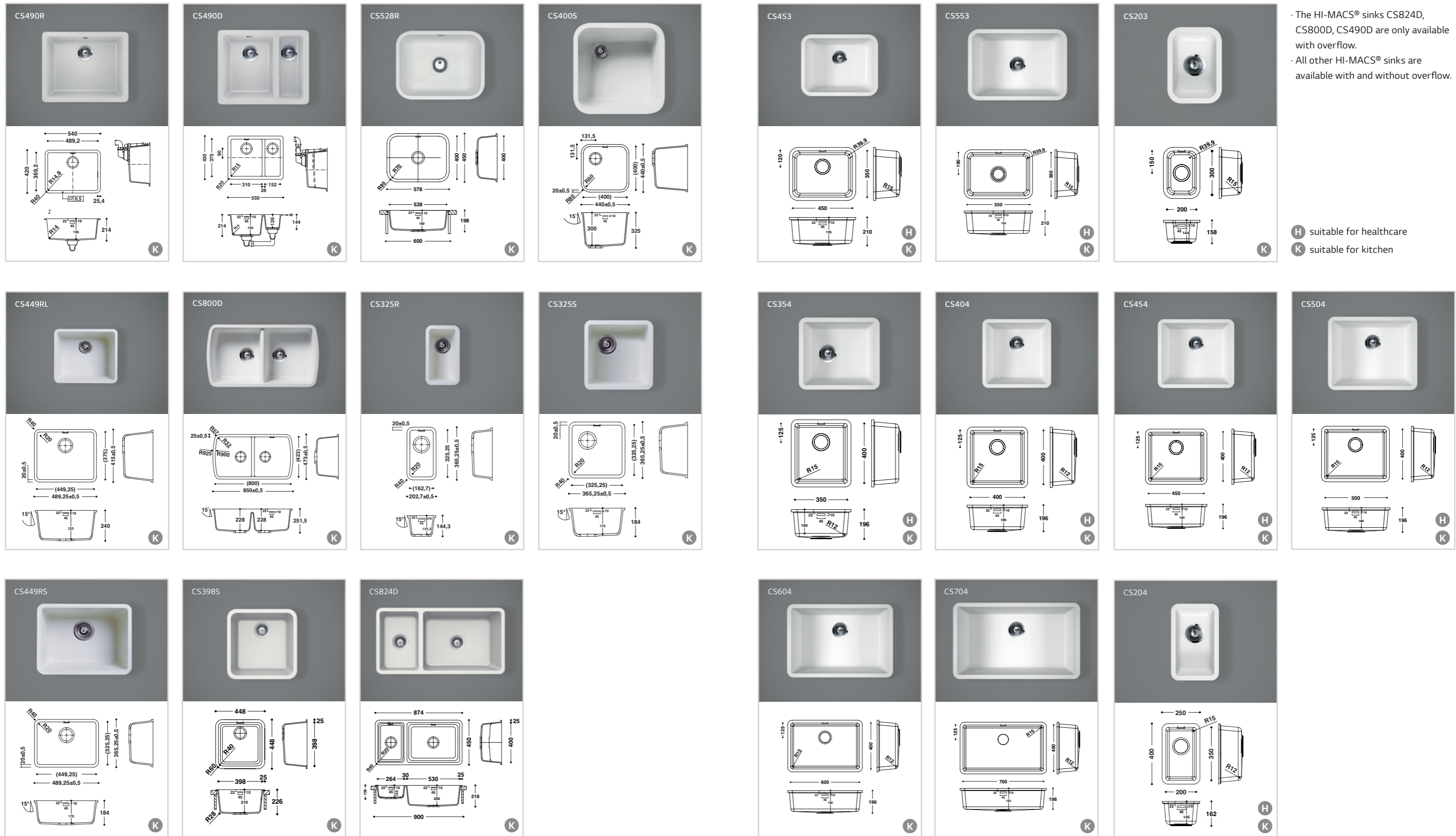

· The HI-MACS® sinks CS824D, CS800D, CS490D are only available with overflow.  
 · All other HI-MACS® sinks are available with and without overflow.

# Basins. Best design for the bathroom.



## HI-MACS® Basins for the bathroom

Rectangular or oval, deep or shallow basins, small bathrooms or comprehensive solutions, HI-MACS®'s range offers creative architects and bathroom planner's numerous options.

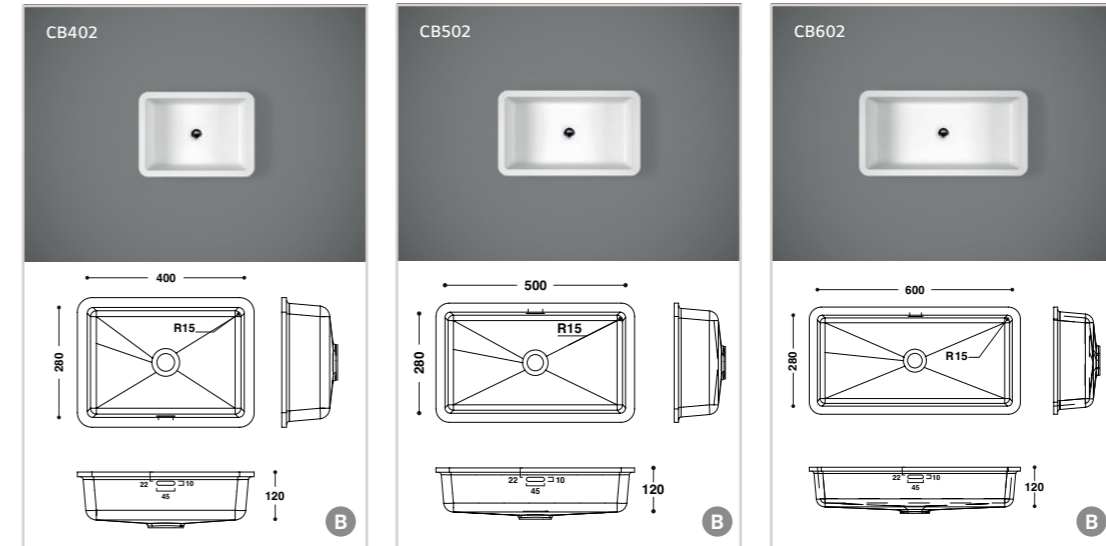

**B** suitable for bathroom

## HI-MACS® Basins for the bathroom – Top mount installation

These three basins are HI-MACS® answer to the trend for linear designs. All three basins were exclusively designed as top-mounted bowls. The narrow radius of the two rectangular models creates exceptionally spacious basins.

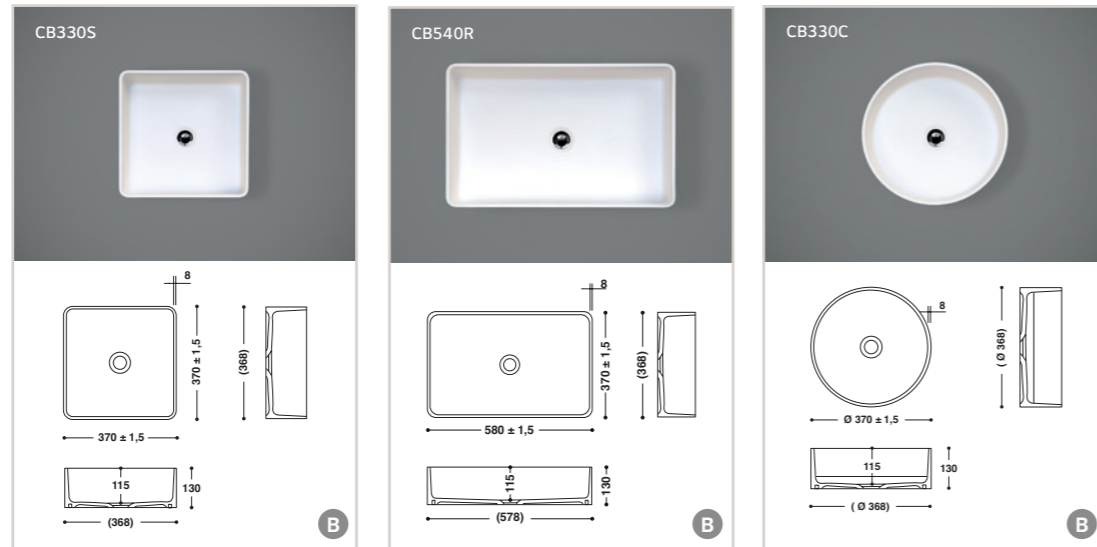

## HI-MACS® Baby Bath

The neo-natal ward of a hospital is the one place where maximum hygiene, ergonomics and warmth are essential. The ergonomic shape of the bowl is specifically designed for babies.

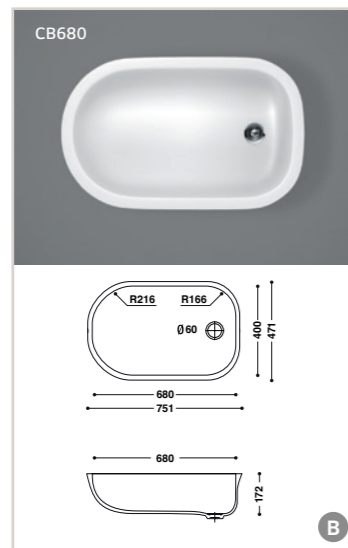

- The HI-MACS® basins CB523, CB723, the HI-MACS® Top Mounted Basins Collection and the HI-MACS® Baby Bath are only available without overflow.
- All other HI-MACS® basins are available with and without overflow.



HI-MACS® sinks, washbasins and Baby Bath are exclusively available in Alpine White S028.

Warranty: 15 years on all precast HI-MACS® basins, sinks and baby bath.

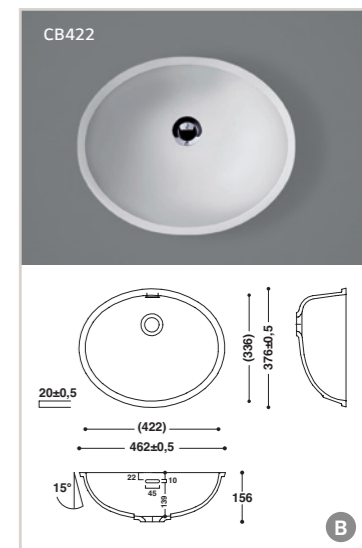
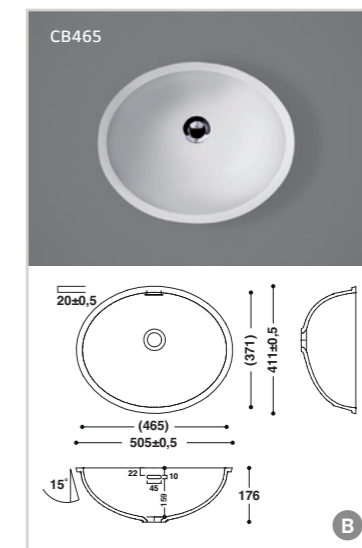
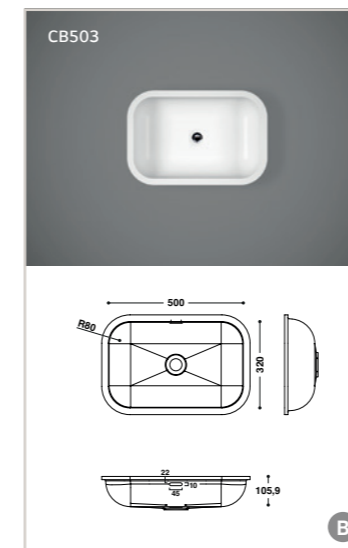
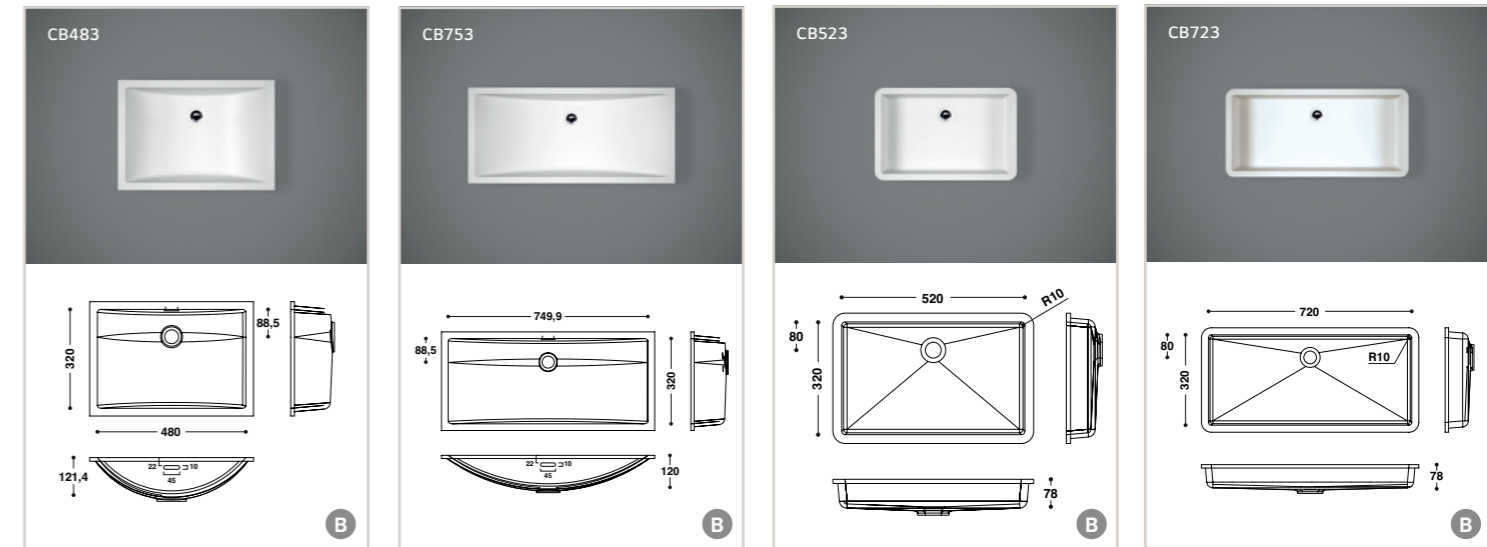

Please feel free to contact us  
for further information.

HI-MACS®. Because Quality Wins.

European Headquarters:  
LG Hausys Europe GmbH  
Lyoner Str. 15  
60528 Frankfurt  
Germany  
info@himacs.eu

To find the contact for your region, please visit our website.

himacs.eu



HI-MACS® Natural Acrylic Stone™ and HI-MACS Structura® are registered trademarks of LG Hausys Europe GmbH. All other trademarks and product names are trademarks or registered trademarks of their respective rights owners. The information contained in this brochure is intended to be for information only and can be amended at any time without prior notification. ©2019. LG Hausys Europe GmbH. All rights reserved.

