

BECAUSE  
**QUALITY**  
WINS

 **LG Hausys**

[www.himacs.eu](http://www.himacs.eu)

# HI-MACS®

Perfect for the kitchen.  
Perfect for the bathroom.

 Natural Acrylic Stone™

# What's the perfect material for bathrooms?

Bathrooms should be a haven of tranquility, as well as being functional. The ideal material in this room should not only be hygienic and water resistant, but also have a soft, warm touch. And, above all, it needs to be so flexible in terms of design that every last design vision can be transformed into reality: from minimalist and linear to delicate and opulent. HI-MACS® can be all those things – and can create all those things as well.



# Nowhere does quality count more than in the kitchen.

Fine culinary artistry is celebrated in the kitchen. The demands are often exacting when it comes to handling high-quality foods and top kitchen equipment. The requirements in terms of functionality, durability, robustness, as well as aesthetics and comfort, simply couldn't be more demanding: right here in the heart of the house.



# HI-MACS® inspires in the kitchen.

## HI-MACS® is hardwearing and resistant

- HI-MACS® is 100% water-resistant
- HI-MACS® is resistant to almost all commercial household chemicals, and everyday stains such as fruit acid or red wine
- HI-MACS® is scratch-resistant and can be repaired in the event of small scratches – without the need to call in a tradesman
- HI-MACS® is heat-resistant thanks to new Thermalcure-technology

## HI-MACS® is very easy to clean

- HI-MACS® can be cleaned using a moist cloth and commercial detergent, removing almost all dirt without leaving any residue
- HI-MACS® is hygienic and can be assembled without the need for visible joints, preventing germs, bacteria and pathogens accumulating in the first place
- HI-MACS® offers a wide range of sinks and basins, which can also be seamlessly integrated with the worktop

## HI-MACS® looks fantastic

- HI-MACS® has a natural matt satin finish, which can be given a high-gloss polished finish on request
- HI-MACS® offers a broad selection of attractive shades – elegant solid colours in classic shades and new trend colours, added every year – as well as many natural stone designs
- HI-MACS® can be machined just like hardwood or three-dimensionally moulded, and also offers the option of creating spectacular lighting effects using rear-milled cut-outs

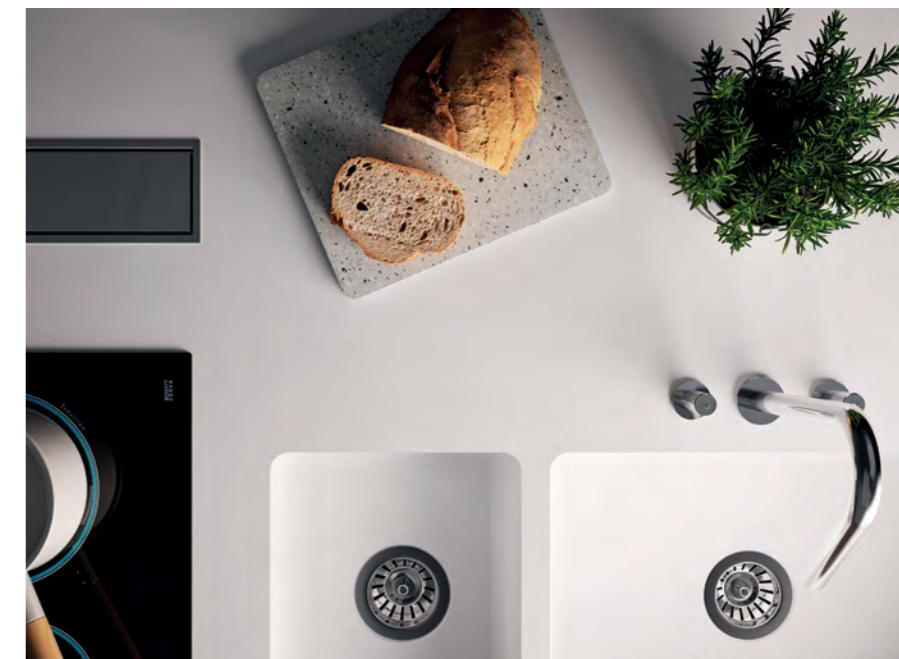

# Everything leads to the use of HI-MACS® in the bathroom.

## HI-MACS® is easy to use

- HI-MACS® is 100% water-resistant
- HI-MACS® is resistant to almost all commercially available household chemicals
- HI-MACS® is scratch-resistant and can be repaired in the event of small scratches – without the need to call in a tradesman

## HI-MACS® is very easy to clean

- HI-MACS® can be cleaned using a moist cloth and commercial detergent, removing almost all dirt without leaving any residue
- HI-MACS® is hygienic and can be machined without the need for visible joints, preventing the build-up of germs, bacteria and pathogens
- HI-MACS® offers a wide range of round, angled or oval wash-basins, which can also be ultra-hygienically and seamlessly integrated or installed as fashionable topmounted basins.

## HI-MACS® looks amazing

- HI-MACS® has a matt satin finish with an extremely pleasant feel: as if designed specifically for bathrooms – which can be given a high-gloss polished finish, on request
- HI-MACS® offers a generous selection of attractive shades: countless elegant shades of white and more solid colours in classic shades and new trend colours, added every year
- HI-MACS® can be three-dimensionally moulded, offering the option of creating spectacular lighting effects using rear-milled cut-outs



In the kitchen the words 'quality' and 'detail' define their meaning.



Apart from a number of uni-colours – including several shades of white – the extensive colour range also includes many attractive stone textures, following to the current trend for natural colours and materials in kitchen design.

Design: PLAN W GbmH – Photo: Heinrich Hermes



Extensive surfaces without visible joints make working in the kitchen a veritable pleasure. This kitchen also includes HI-MACS® furniture fronts: the handle recesses are simply cut out.



Photographed by Atvanguard

Flushmounted sinks and basins, milled draining grooves, three-dimensionally moulded elements: the range of options for creating design features with HI-MACS® is almost limitless.



HI-MACS® transforms every bathroom into your very own personal oasis of comfort.



The topmounted basins in the HI-MACS® collection combine maximum bowl size with elegant, sleek lines.

Design: Roth kreativ GmbH | Photo: Studio Hetzer



All the functional elements in this minimalist elegant bathroom were individually designed with HI-MACS®: the washstand with its dramatic double sink, furniture fronts with bevelled handles, and the room-partition that supports the washstand whilst at the same time forming the shower cladding.

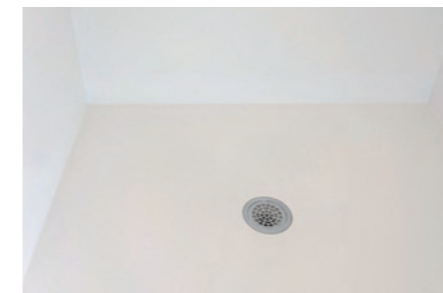

This comfortable shower is completely manufactured from HI-MACS®, creating a hygienic, easy-care zone with a maximum "feel-good" factor.



Straight, curved, rectangular, baroque ...  
any shape you can imagine.

Due to the highly flexible manufacturing options of HI-MACS® your dealer can offer a wide range of attractive and functional edge-treatments and hygienic splashbacks for your kitchen. Here you can see a small selection of the various possibilities

Edge profile examples

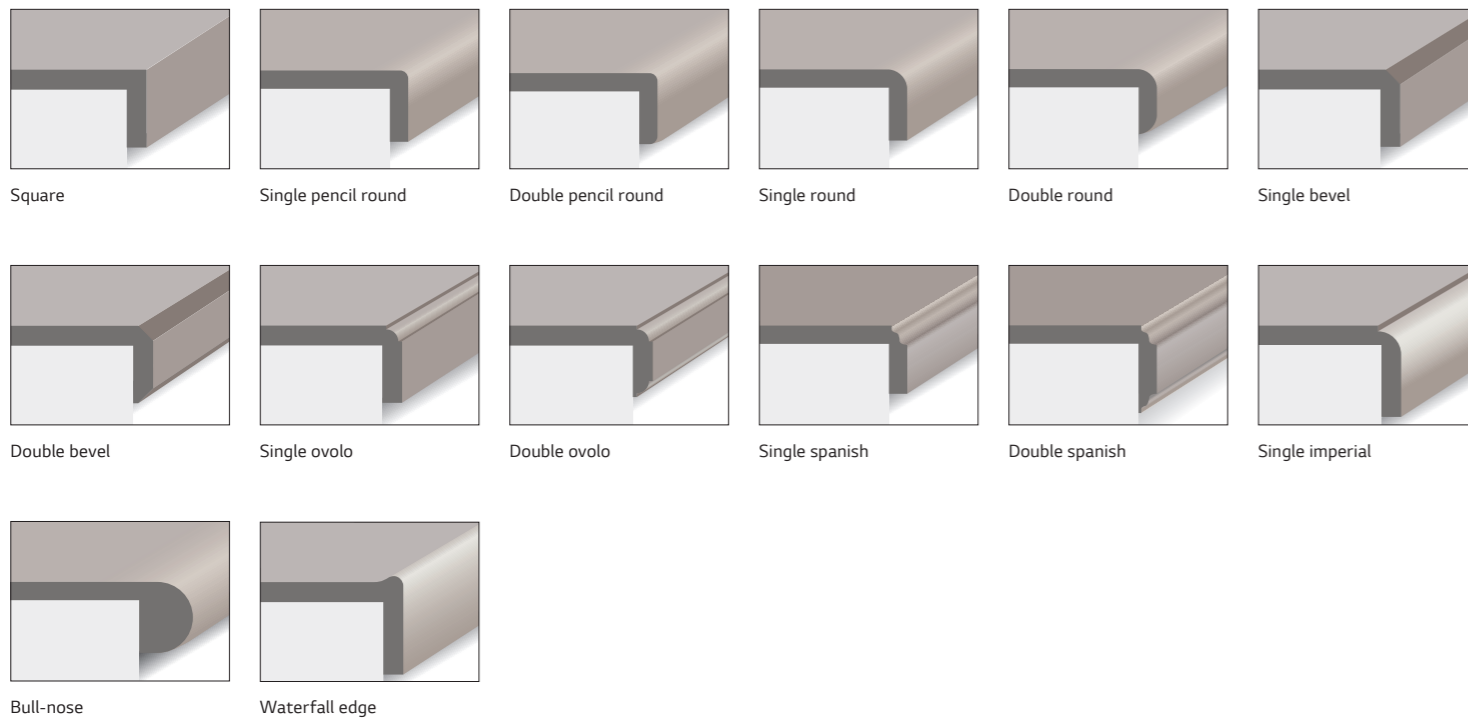

Splashbacks

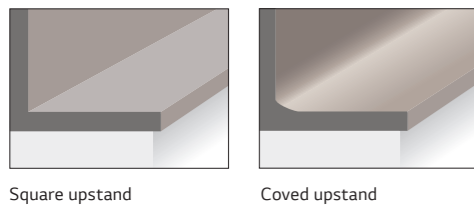

Drainer groove examples

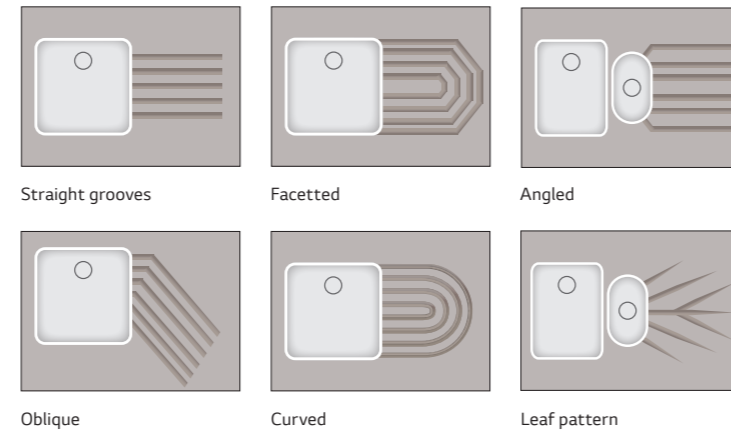

Sinks and Basins

Creative designers have every option at their disposal to create washrooms, kitchens, hospitals and much more with the extensive range of HI-MACS® basins and sinks.



# Sinks.

## Spacious and elegant.

### HI-MACS® Sinks for kitchen and healthcare applications

Spaciousness, durability and hygiene are all key quality features when choosing a sink for the kitchen or healthcare facility. The top quality models in the HI-MACS® range offer it all. These coordinated sinks are installed as undermounted creating extremely hygienic sink areas. Special custom-made creations are also an option.

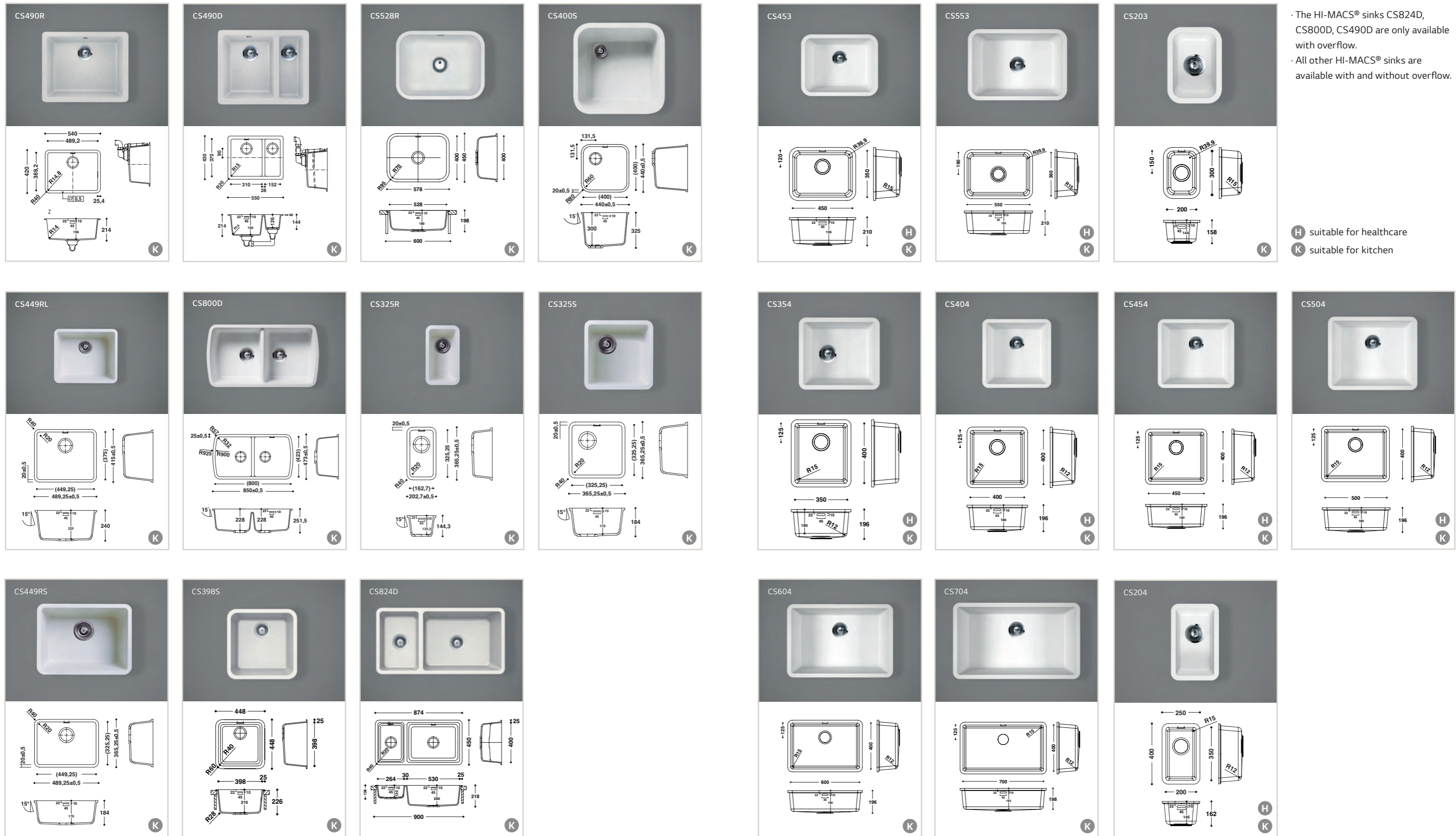

- The HI-MACS® sinks CS824D, CS800D, CS490D are only available with overflow.
- All other HI-MACS® sinks are available with and without overflow.

**H** suitable for healthcare  
**K** suitable for kitchen



# MIXA® Sinks



The extensive collection of MIXA® sinks in the HI-MACS® residential colour range adds to the aspirational design possibilities and practicality of your worktop. The hard wearing stainless steel based sink is seamlessly integrated to give an aesthetically stunning look that is both hygienic and practical.

## Double Sinks

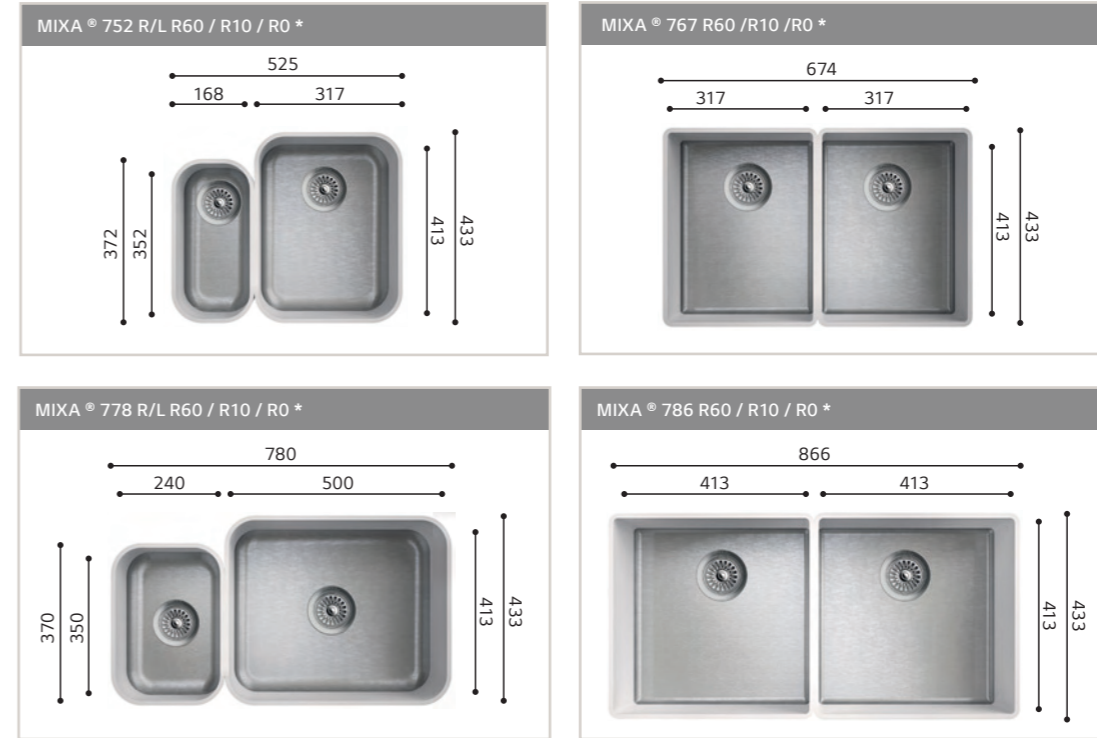

\* Available in R60, R10 and R0 radius corners and the additional option of a black or white enamelled base for R60 and R10 models, providing endless design variations. Recommended for use with boiling water taps and waste disposal units. MIXA® sinks are all covered by a 10 year limited installed warranty when installed by an authorised HI-MACS® fabricator.

## Single Sinks

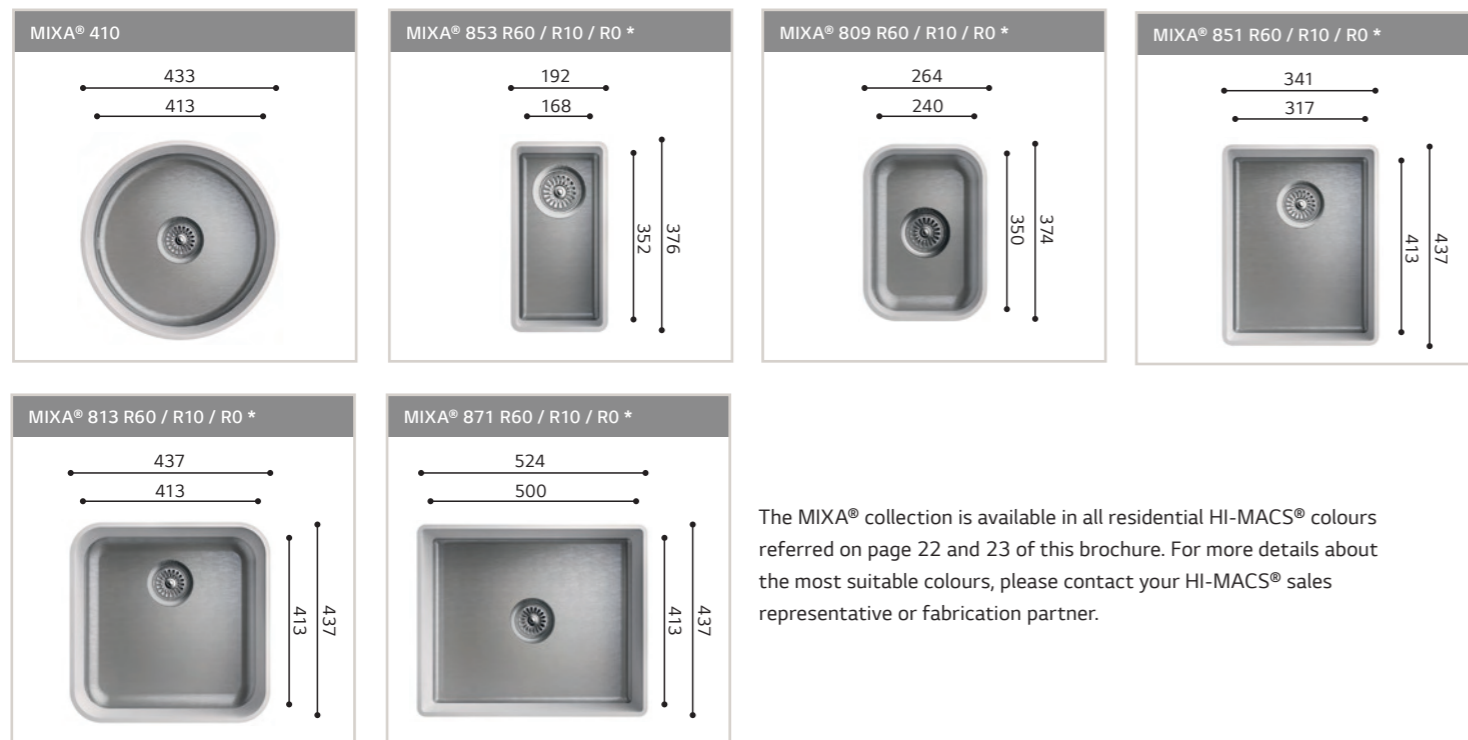

The MIXA® collection is available in all residential HI-MACS® colours referred on page 22 and 23 of this brochure. For more details about the most suitable colours, please contact your HI-MACS® sales representative or fabrication partner.

## XL Sinks

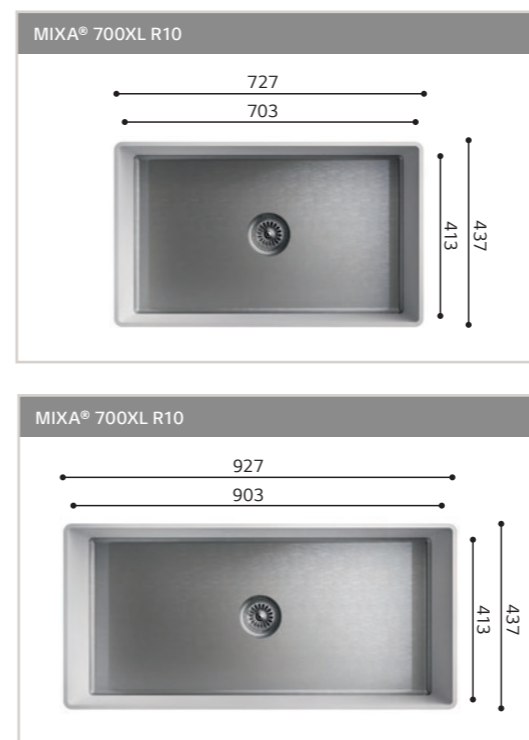

# Basins. Best design for the bathroom.



## HI-MACS® Basins for bathroom

Pleasantly warm to the touch – simple to look after: HI-MACS® washbasins are produced in a casting process and can be perfectly fitted flush or supported in washstands made of HI-MACS®.

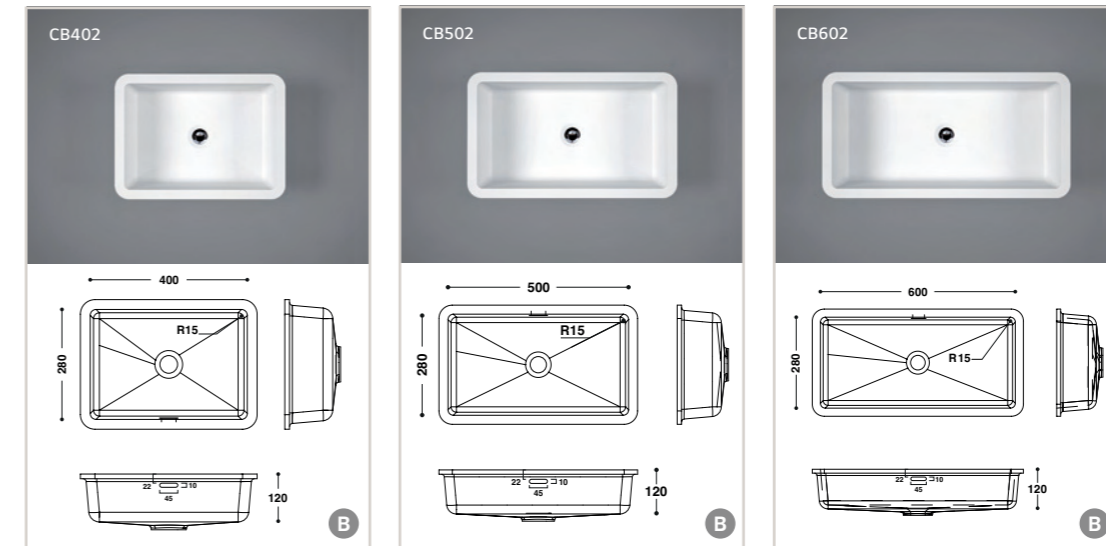

**B** suitable for bathroom

## HI-MACS® Basins for bathroom – Topmount installation

These three shapes are HI-MACS® answer to the trend for linear designs. All three basins were exclusively designed as topmounted bowls. The narrow radius of the two rectangular models creates exceptionally spacious basins.

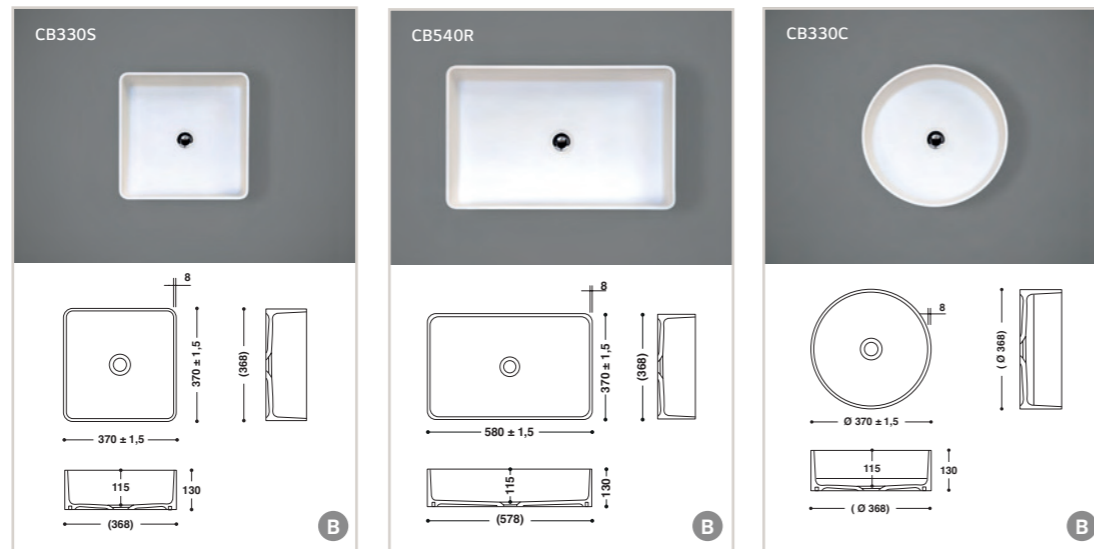

## HI-MACS® Baby Bath

The neo-natal ward of a hospital is the one place where maximum hygiene, ergonomics and warmth are essential. The ergonomic shape of the bowl is specifically designed for babies.



- The HI-MACS® basins CB523, CB723, the HI-MACS® Topmounted Basins Collection and the HI-MACS® Baby Bath are only available without overflow.
- All other HI-MACS® basins are available with and without overflow.

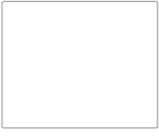

HI-MACS® sinks, washbasins and Baby Bath are available in Alpine White S028.

Warranty: 15 years on all precast HI-MACS® basins, sinks and baby bath.

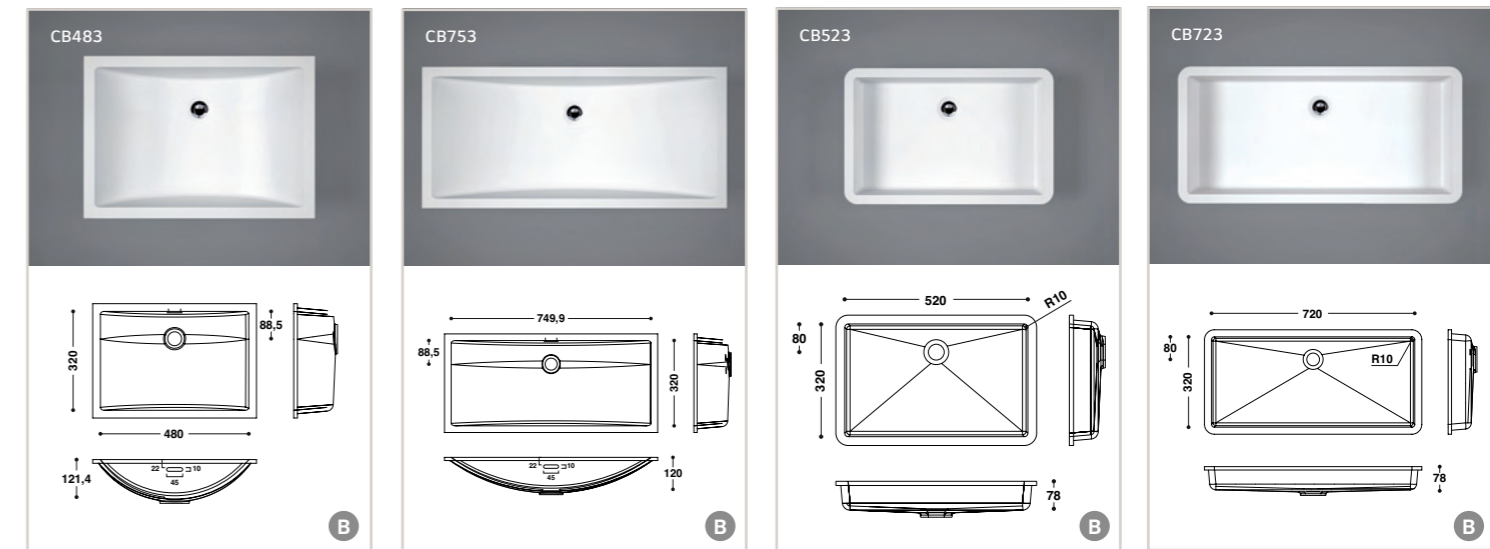

# VIVARI® Basins

An impressive selection of thermoformed and fabricated bathroom products for seamless integration or as stand-alone pieces. Available in all HI-MACS® colours this fantastic collection can make a real statement in any bathroom. All covered by a 2 year limited installed warranty. Please contact your HI-MACS® fabricator or representative to see the whole range of styles and sizes available.

The VIVARI® collection is available in all residential HI-MACS® colours referred on page 22 and 23 of this brochure. For more details about the most suitable colours, please contact your HI-MACS® sales representative or fabrication partner.



To discover the entire HI-MACS® VIVARI® basins range please contact your sales representative or HI-MACS® fabrication partner.

## Topmount

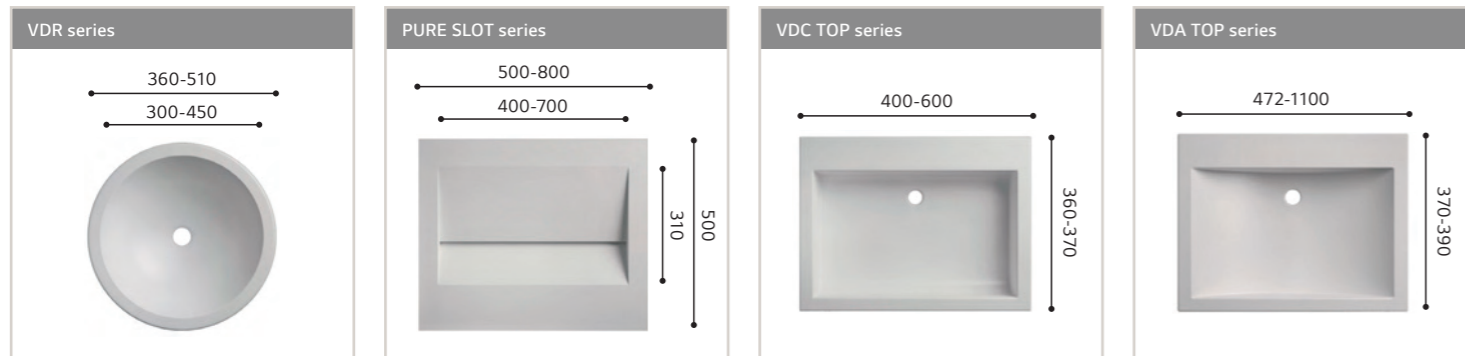

## Undermount

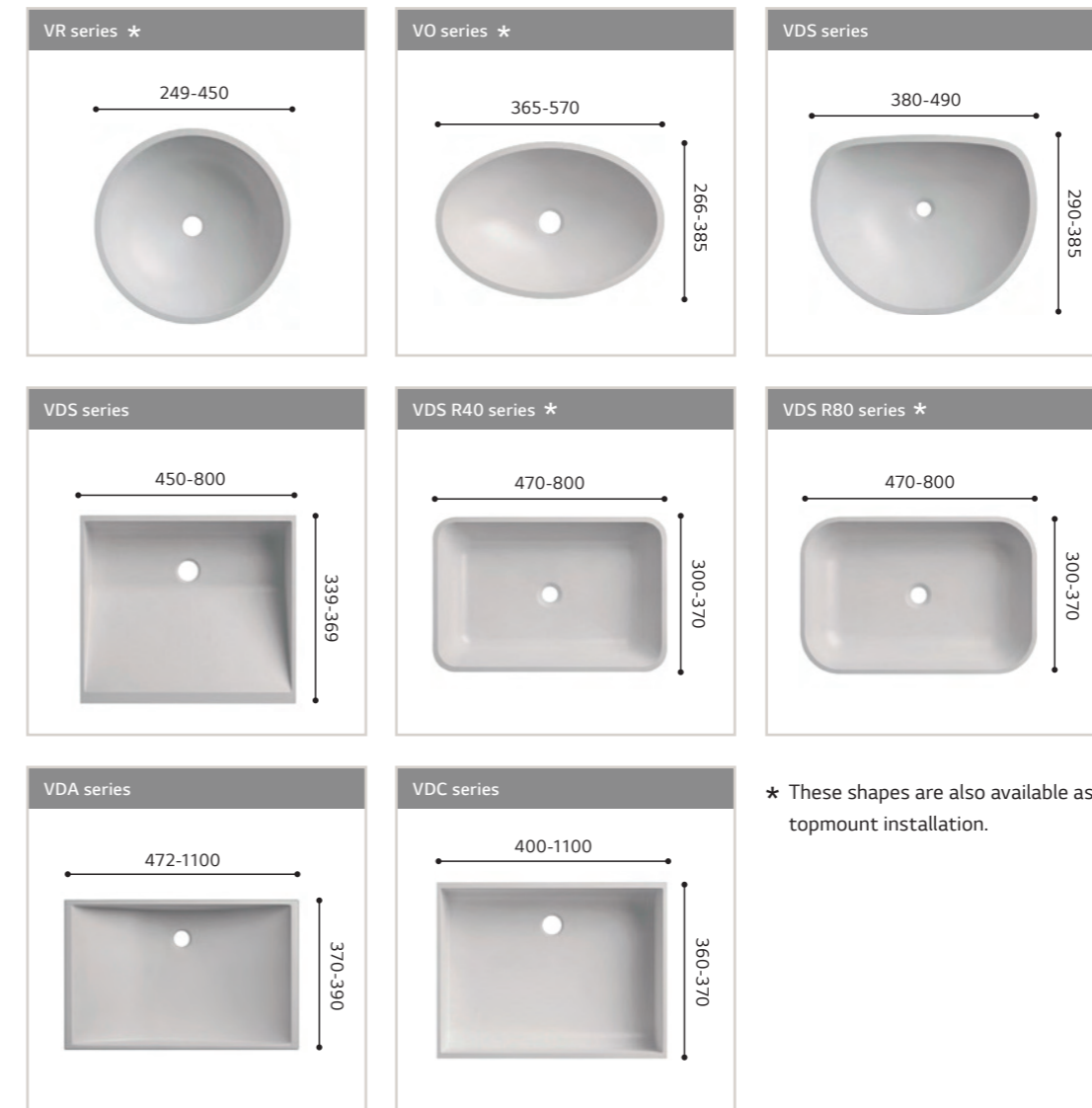

\* These shapes are also available as topmount installation.

# The colours for kitchen and bathroom.

Colours are key in design: elegant Cream, hot Allspice Quartz or delicious Mocha Granite ...

We have whatever you want – it's your choice.

## Concrete Collection

Warm-tones concrete-like finishes are now available in the solid surface material, providing completely new opportunities for architects and designers.

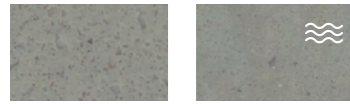

Urban Concrete G554 [20/12 mm] Chic Concrete M551 [12 mm]

## Solids

From elegant to extravagant, classic to ultra-contemporary.



Nordic White S033 [20/12 mm] Alpine White S028 [20/12 mm] Diamond White S034 [20/12 mm] Arctic White S006 [20/12 mm] Ivory White S029 [20/12 mm] Satin White S001 [20/12 mm] Cream S009 [20/12 mm] Nougat Cream S201 [20/12 mm]

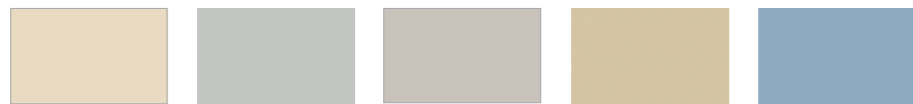

Almond S002 [20/12 mm] Grey S005 [20/12 mm] Suede S121 [20/12 mm] Babylon Beige S102 [20/12 mm] Sky Blue S203 [20/12 mm]

20 mm: S028 Alpine White available in stock. All other colours available on special request, except for Marmo Collection and Chic Concrete.

## Marmo

Captivating random veined texture, reminiscent of marble.

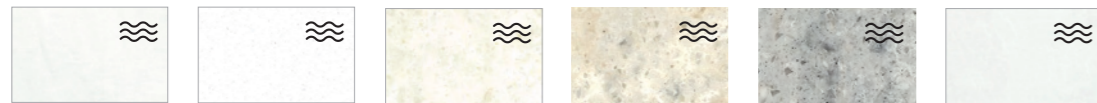

Breeze White M306 [12 mm] Edessa M501 [12 mm] Bellizzi M427 [12 mm] Cremona M422 [12 mm] Laviano M426 [12 mm] Ispani M428 [12 mm]

## Aster (Galaxy)

With transparent grains and mother of pearl shimmer.



Nebula T010 [20/12 mm] Andromeda T017 [20/12 mm] Carina T018 [20/12 mm]

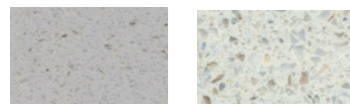

New Moon T019 [20/12 mm] Venus T011 [20/12 mm]

## Volcanics

Looks like a precious natural stone but with all of the advantages of "Natural Acrylic Stone™".



Gemini VW01 [20/12 mm] Tambora VE01 [20/12 mm] Santa Ana VA01 [20/12 mm]

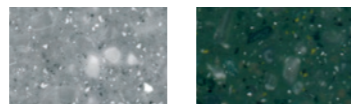

Frosty VA22 [20/12 mm] Maui VG21 [20/12 mm]

Notice: The basic HI-MACS® material is identical for every colour, although darker hues have a higher percentage of natural pigments. There may be some slight variation in colour between the illustrated and actual colours due to printing techniques. The recommended finish for kitchen worktops is semi-matt.

≈ Marmo is a randomly veined product, specific fabrication guidelines need to be followed. Ask your sales partner for more information, and see more details at [himacs.eu](http://himacs.eu).

# Care and Maintenance

HI-MACS® Natural Acrylic Stone™ is hard-wearing, durable and extremely resistant to stains and is therefore very easy to look after. Below are a few simple tips and hints for caring for HI-MACS® to help maintain its exceptional quality for many years to come.

## General day-to-day stains

HI-MACS® is a completely homogenous material. As it does not have any pores, you can simply and easily clean it with a damp cloth or sponge and a mild detergent. You can also use a domestic scouring agent on all matt finishes. It is useful to wipe your surface occasionally with a scouring agent or wet sponge to retain the even finish of your product.

## Acidic cleaning agents

A number of cleaning agents contain acids, such as methyl chloride or acetone. You should avoid using these on a HI-MACS® surface. Should one of these products accidentally come into contact with the material, as a precautionary measure you should rinse the surface with soapy water to prevent any discolouring taking place.

## Burn marks

Small burn marks or marks caused by nicotine can simply be removed using a scouring agent or an abrasive sponge. Should this give the high-gloss finish a matt appearance, rubbing the surface with a scouring pad will quickly return it to its high-gloss state.

## Tougher stains

Tougher stains, caused by food colouring, tea or fruit juice can easily be removed using a bleaching agent (do not leave in contact with the work surface for more than five minutes). Clean the surface with a domestic all-purpose cleaner and rinse with clean water. You can also use a scouring agent on matt finishes. Nail varnish can easily be removed with nail varnish remover (acetone-free) or a scouring agent.

## Hot objects and boiling water

Hot saucepans or pots straight out of the oven or from the hob should not be laid directly on the HI-MACS® surface. Place a mat or board underneath to prevent any damage to your product. If you pour boiling liquids into HI-MACS® sinks or basins, you should also pour in cold water at the same time. This also applies to the use of boiling water taps.

## Sharp objects

HI-MACS® copes effortlessly with the wear and tear of everyday life, however pointed or sharp-edged objects can leave cuts or scratches on the HI-MACS® surface. You can repair smaller cuts and scratches without too much trouble but we recommend the services of a professional for especially deep cuts.

## Granite, Sparkle, Quartz, Sand & Pearl

A huge selection of textures and colours. Natural, elegant and perfect in combination.

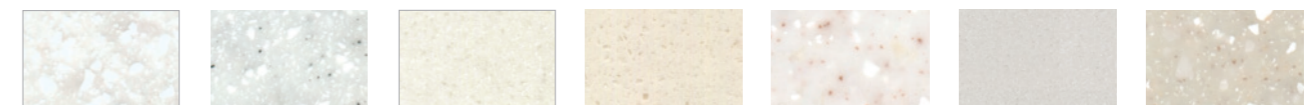

Arctic Granite G034 [20/12 mm] White Quartz G004 [20/12 mm] Lunar Sand G108 [20/12/9 mm] Crystal Beige G101 [20/12 mm] Tapioca Pearl G050 [20/12 mm] Pebble Pearl G107 [20/12 mm] Sea Oat Quartz G038 [20/12 mm]

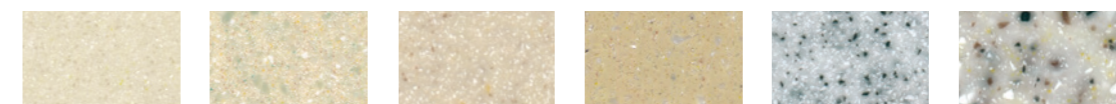

Riviera Sand G106 [20/12/9 mm] Moonscape Quartz G058 [20/120 mm] Beach Sand G048 [20/12 mm] Peanut Butter G100 [20/12 mm] Grey Sand G002 [20/12 mm] White Granite G005 [20/12 mm]

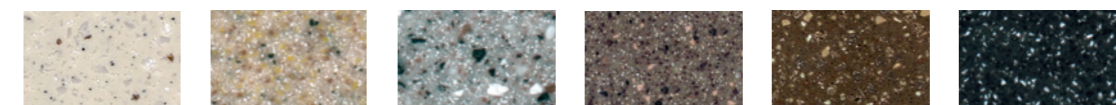

Grey Crystal G102 [20/12 mm] Desert Sand G001 [20/12 mm] Platinum Granite G007 [20/12 mm] Allspice Quartz G063 [20/12 mm] Mocha Granite G074 [20/12 mm] Black Sand G009 [20/12 mm]

Sparkle colour designed by Karim Rashid: Kold Silver P102 [20/12 mm]

## Lucia

Natural colour trends characterised by linear-edged, midsize particles: two of those designed by Dutch Star Designer, Marcel Wanders.

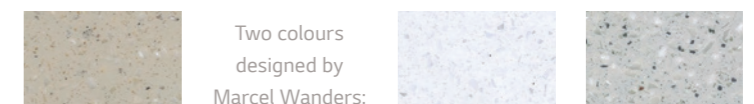

Lentil W007 [20/12 mm] Ice Queen W001 [20/12 mm] Shadow Queen W003 [20/12 mm]

*karim*



mārcel wānders®

# Resistant for your benefit.

CLASS	STAINING AGENT	APPLICATION TIME	EVALUATION OF G002 CHANGES	EVALUATION OF S028 CHANGES
GROUP 1	Water	16h – 24h	5 to 4	5 to 4
	Toothpaste			
	Hand cream			
	Natural fruit and vegetable juice			
	Lemonade and fruit drinks			
	Meats and sausages			
	Animal and vegetable fats and oils			
	Salt (NaCl) solutions			
	Mustard			
	Lyes, soap solutions			
	Cleaning solution			
	Alcoholic beverages			
	Phenol and chloramine-T disinfectants			
Citric acid (10% solution)				
GROUP 2	Coffee (120gr coffee per ltr. water)	16h	5	4 to 5
	Black tea (9gr tea per ltr. water)			
	Milk (all types)			
	Cola beverages			
	Wine vinegar			
	Alkaline-based cleaning agents (10% in water)			
	Lipstick			
	Water colours			
	Laundry marking inks			
	Ball point inks			
GROUP 3	*Acetone	10min.	5 to 4	4 to 5
	Concentrated vinegar (30% acetic acid)			
	Nail varnish			
	Nail varnish remover			
GROUP 4	*Acetic acid (5% solution)	20min.	5	4

· HI-MACS® is extremely hard-wearing and durable and transforms your kitchen or bathroom into a universally functional room.

· Tests carried out in accordance to EN ISO 19712 for Solid Surface material, please see table (left) for results.

a = Acids and alkalis, in concentrations stronger than those shown in group 3, which can be contained in commercial cleaning agents, can cause surface damage or marking, even with very short contact times. Any spillage of such materials should be washed off immediately.

## Evaluation

RATING LEVEL	DESCRIPTION
Rating 5	No visible change
Rating 4	Slight change in gloss and/or colour, only visible at certain viewing angles
Rating 3	Moderate change in gloss and/or colour
Rating 2	Marked change in gloss and/or colour
Rating 1	Surface distortion and/or blistering

Please feel free to contact us for further information.

HI-MACS®. Because Quality Wins.

European Headquarters:  
 LG Hausys Europe GmbH  
 Lyoner Str. 15  
 60528 Frankfurt  
 Germany  
 info@himacs.eu

To see more kitchen and bathroom styles or to find the contact for your region, please visit our website.

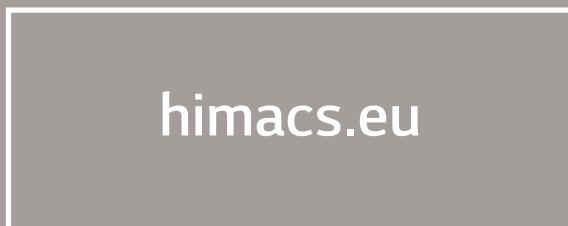

HI-MACS® Natural Acrylic Stone™ and HI-MACS Structura® are registered trademarks of LG Hausys Europe GmbH. All other trademarks and product names are trademarks or registered trademarks of their respective rights owners. The information contained in this brochure is intended to be for information only and can be amended at any time without prior notification. ©2019. LG Hausys Europe GmbH. All rights reserved.

Publisher's Details:  
 Heinrich Hermes, heinrich-hermes.de | Pfeiffer GmbH & Co. KG, pfeiffer-germany.de | Plan W GmbH, planw.com | Roth kreativ GmbH, rother-punkt.de | Studio Hetzer, studio-hetzer.de | Studio Podrini, studiopodrini.com

