

# logik™

The leading high performance,  
sustainable window & door system

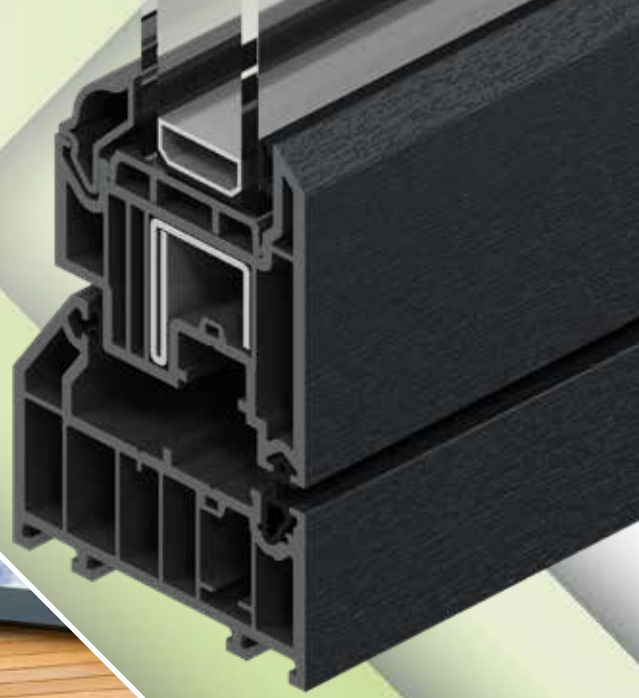

**MADE & RECYCLED  
IN THE UK**



**eurocell®**

All together better

**NEW**

**logik** ™

**NEW FLUSH SASH WINDOWS**

# INTRODUCING THE LOGIK S FLUSH SASH



## Flush Sash

Business has never looked better.

Logik has been a favourite with fabricators and installers for many years now. With all the advantages it offers over other systems, it's no wonder. From game changing features like its unique knock-in bead system to the single steel reinforcement bars that make it a byword for strength and security, Logik is the name people look for in the trade.

We're always looking for new ways to improve the quality of our products, the ease of their fit and the level of business they bring in for our customers. And for Logik, that's meant developing a third frame style to add to our Chamfered and Ovolo ranges - the Logik Flush Sash.

### Opening up new markets

The Flush Sash is the Logik frame everyone's been waiting for. Homeowners, because it means they can have the look of a genuine timber frame with all the energy efficiency and low maintenance benefits of PVC-U.

Installers, because it gives them a modern new look in a range of on-trend colours – including through-colour grey – to offer to style conscious customers.

### A perfect addition to the range

And like the rest of the Logik range, an extensive choice of woodgrain foils gives Logik S Flush Sash a real wood look that stands up to all but the closest of inspections. Or in grey delivers an architectural design feel. It's the perfect replacement window for adding contemporary kerb appeal to older homes or retaining character in older properties.

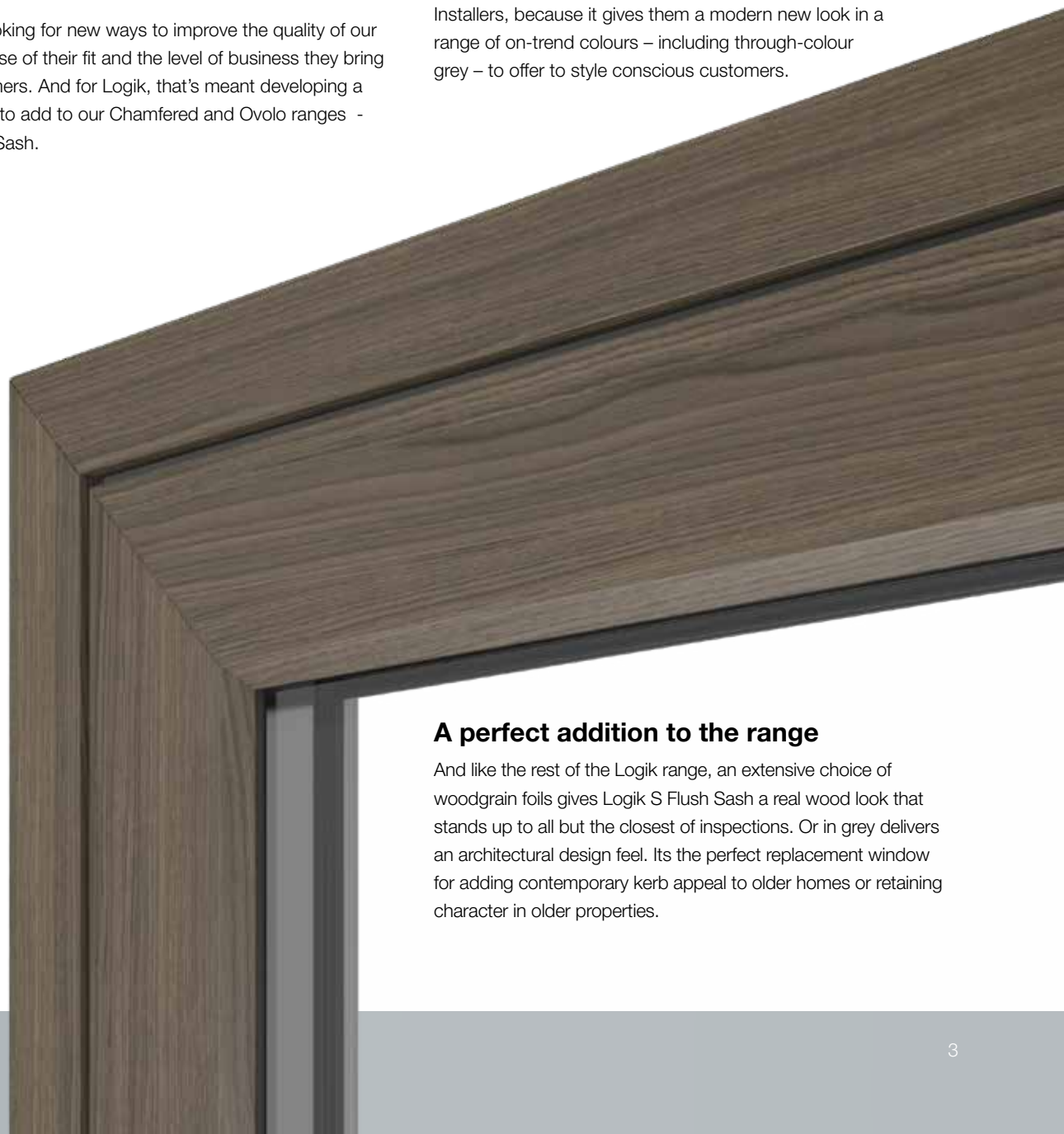

# 3 SASH STYLES IN 1 SYSTEM



**logik** **S**<sup>TM</sup>  
Flush sash

**NEW**

**Market leading looks**

With a perfectly flush sash external appearance, Logik S Flush Sash will bring the smooth, seamless lines that are so popular in architectural design nowadays to any new build project.



**logik**<sup>TM</sup>  
Chamfered



**logik**<sup>TM</sup>  
Ovolo



# A GREY REVOLUTION

NEW

The outstanding feature that makes Logik so special, though, is its grey substrate option.

With a through-colour grey frame instead of just a surface foil, there's no sign of a white PVC-U core, even when you open the window.

It may seem like a small detail, but the all-grey look is a big thing with homeowners right now and many people are more than ready to pay a premium for it in PVC-U rather than choose the much more expensive aluminium option.

So make sure you're ready to supply everything they're looking for with new Logik S Flush Sash to complement the Logik chamfered and Ovolo options.

## GREY SUBSTRATE OPTION FOR THE CONSISTENT LOOK

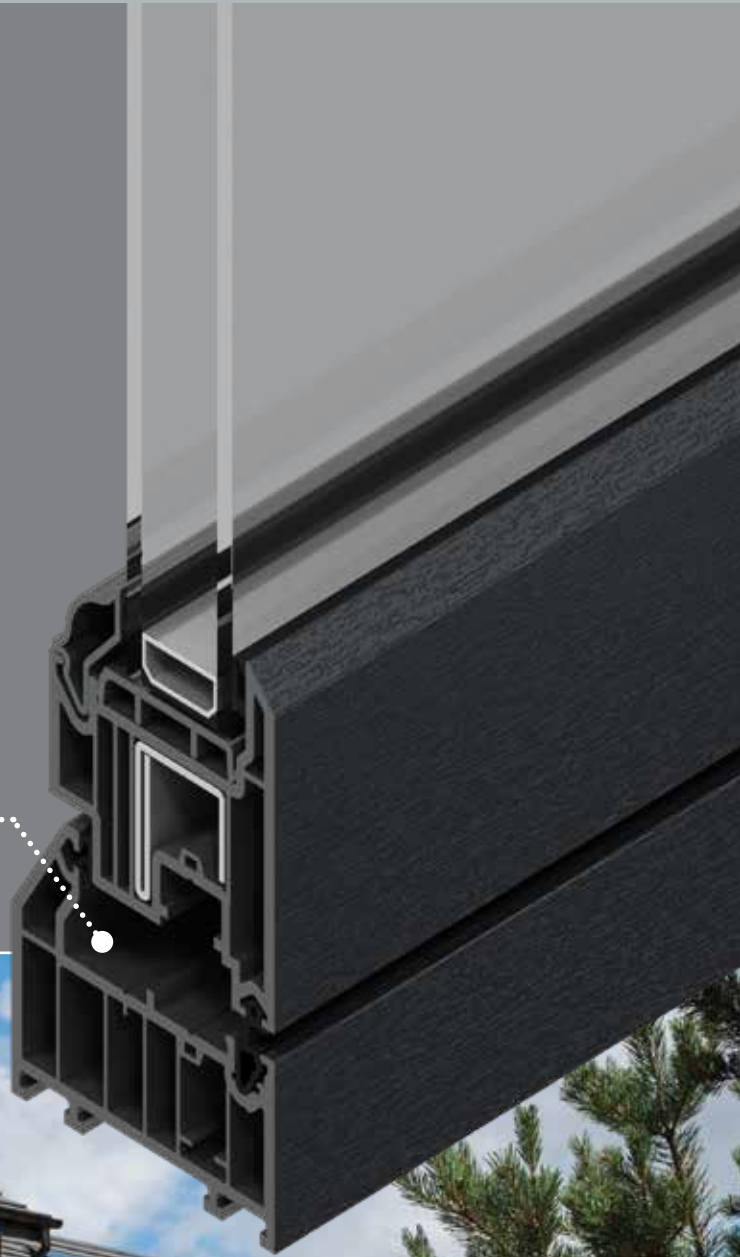



logik™

## A PROFILE SYSTEM DESIGNED FOR ENHANCED AESTHETICS AND EASE OF FABRICATION

The Logik profile system from Eurocell combines leading energy efficiency performance and aesthetics with ease of use – for the ultimate system

The Logik profile system combines leading energy efficiency performance and aesthetics with ease of use, for the ultimate system. Logik is specially designed for ease and speed of fabrication and fitting, featuring a unique, patented knock-in bead system. Ideally suited for new build or replacement windows, its 70mm front-to-back dimension enables the seamless replacement of timber frames.

Logik is designed for improved aesthetics and clean sight lines, with its unobtrusive gasket line and slim profile. The profile features multiple chambers to enhance thermal

efficiency and strength, and improve drainage. Available with chamfered or sculptured ovolo styles in a range of colours, Logik window profiles add a touch of distinction to any home.

### **The sustainable option**

Logik features post-consumer recycled PVC-U in the central core of the profile with virgin PVC-U on seen faces. This ensures the same aesthetics and technical performance but with more environmentally responsible benefits for today's discerning customers. It offers the same benefits but with more sustainability – at no extra cost to you.

# WHY CHOOSE LOGIK?



**Outstanding technical performance**



**Fast, accurate fabrication and installation**

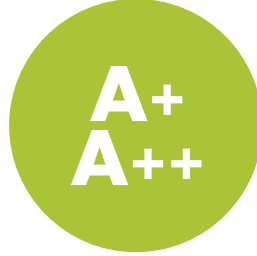

**Superb energy efficiency performance**



**U-values as low as 0.8**



**BBA certified system**



**Market-leading sustainability**



**Wide range of colour and style options**



**10-year guarantee for peace of mind**

## Leading energy efficiency

Maximising the thermal performance of windows is vital to meet rising regulatory and customer demands. The advanced multi-chambered design of the main Logik profiles and innovative PVC-U Thermal Inserts work together to lock in heat. This means our 'A+'-rated windows offer market-leading double-glazed unit performance and value.

## Exceptional air tightness and weathering performance

The post co-extruded (PCE) gaskets on Logik profiles use a specially developed compound and twin-leg profile connection system with one-way support arm. This provides excellent adhesion to the main profiles. Tested to BS6375, the gasket system achieves outstanding air tightness and weathering performance, improving energy efficiency further by minimising air leakage.

**logik™ products available**

**STANDARD CASEMENT WINDOWS**

**FLUSH CASEMENT WINDOWS**

**TILT AND TURN WINDOWS**

**FRENCH WINDOWS**

**RESIDENTIAL DOORS**

**FRENCH DOORS**



# ADVANCED PERFORMANCE

LEADING TECHNICAL & SUSTAINABILITY PERFORMANCE

## 3 SASH OPTIONS IN ONE FOR A VERSATILE SYSTEM

### GREY SUBSTRATE OPTION FOR THE CONSISTENT LOOK .....

#### Enhanced aesthetics for a brighter outlook...

Not only does the innovative six-chambered outer frame option perform better than standard 70mm window profiles, it looks better too. Slimmer than standard systems, it gives any window a sleek, contemporary appearance, increasing the area of glass for improved sight lines and brighter interiors.

#### A++ performance

A+ Window Energy Ratings (WER) are achievable with Logik – offering market-leading window performance using argon gas. Logik is capable of an A+13 rating (double-glazed) and an A++20 rating (triple-glazed). What's more, U-values as low as 1.2 can be achieved with a double-glazed unit and 0.8 with a triple-glazed unit.

#### PVC-U Thermal Inserts

PVC-U Thermal Inserts for Logik profiles are the sustainable way to improve your window energy efficiency. The multi-chambered design delivers significantly improved thermal performance, more efficient fabrication and 20% lighter weight than windows with conventional steel reinforcements.

#### Quality controlled manufacturing

Quality is carefully controlled and monitored throughout the manufacturing process of the Logik profile system. We have our own toolmaking and laminating facilities, manufacture in our own PVC-U compound mixing plant, giving us full control over product quality and consistency – right from the start.

#### High-performance products

Exposed to the elements, windows need to be hard-wearing, weather resistant and long lasting. The Logik window system will enable you to meet and exceed all of these requirements.

#### Up to 10-year guarantee

Logik profiles are guaranteed for ten years against warping, cracking and discolouration. That means you can give your customers the assurance of a robust, well-designed, precision-made product that's built to last.

# DOUBLE OR TRIPLE GLAZING OPTIONS

REINFORCEMENT  
OPTIONS

THERMALLY EFFICIENT DESIGN  
MULTI-CHAMBERED PROFILES  
OR THERMAL INSERTS

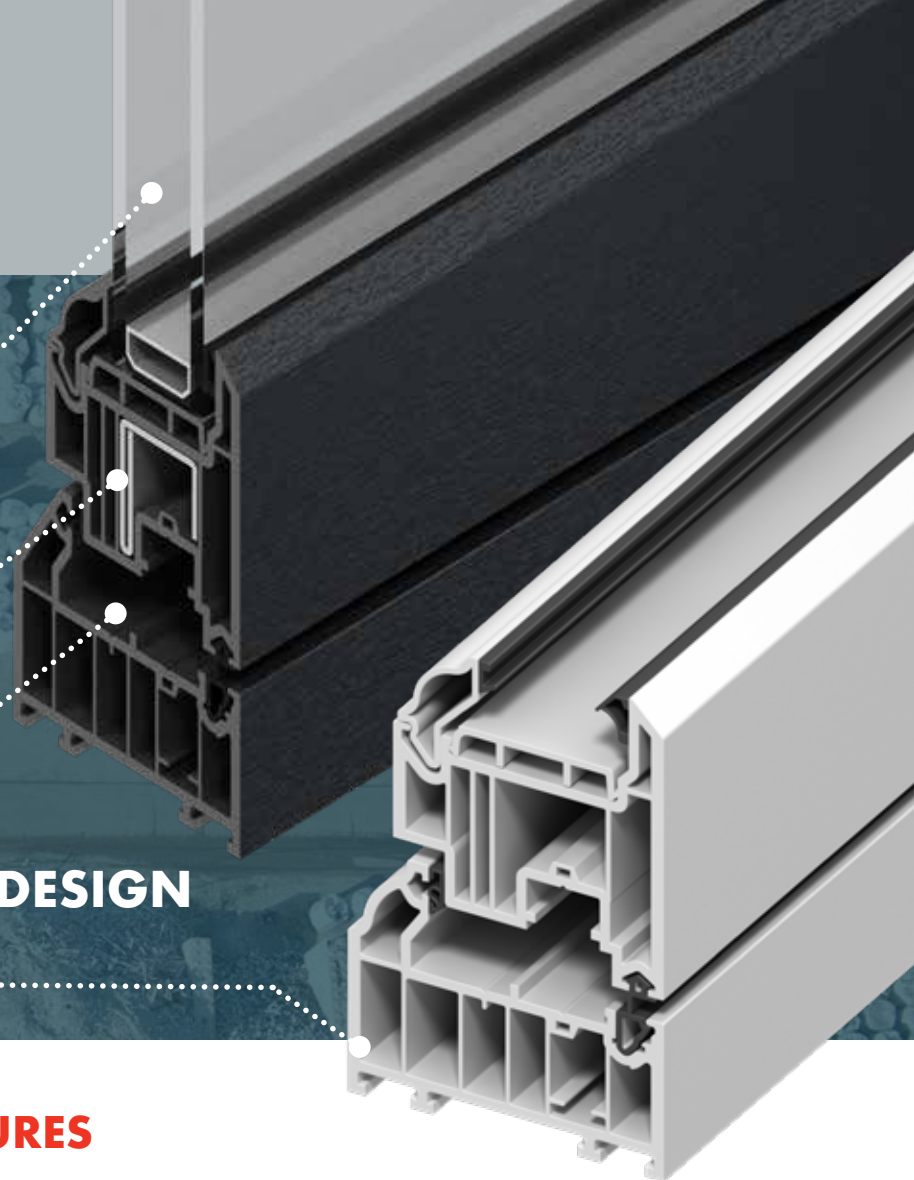

## MARKET-LEADING FEATURES

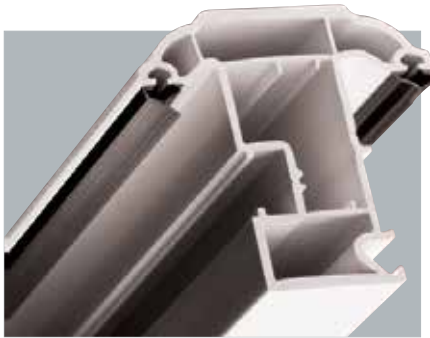

Full depth eurogroove for maximum hardware compatibility



Soft line bevel feature is matched by the bead



Single hinge and espagnolette location in sashes for ease of fabrication



PCE gaskets offer market leading adhesion, air tightness and weather performance

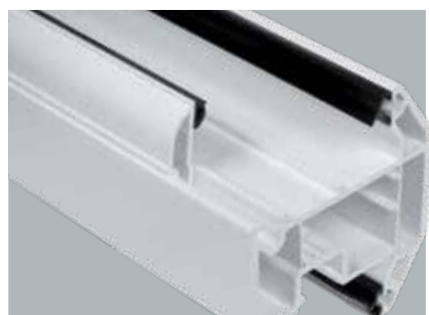

Unique patented knock-in bead system available with 28mm and 36mm putty line



Assessment report number 14/5154



# FABRICATION

FAST, EFFICIENT AND CONSISTENT



## Why fabricate with Logik?

At Eurocell, we understand the demands of your business and Logik is purpose designed to make fabrication quick, simple and economical - with absolutely no compromise on quality or performance.

Logik ensures your reputation remains as robust, watertight and reliable as the finished product you supply to your customers.

## Choose Logik and you can rely on a proven, flexible profile solution that offers:

Strength and durability. A single steel reinforcement bar makes mainframes and transoms stronger and reduces flexing, while continuous reinforcement across all reverse butt-welded joints adds extra rigidity.

## Ease and economy

A common glass size for all Logik windows and doors makes ordering and fitting easier. Plus, pre-installed, low line gasketing speeds up fabrication and does away with the need to buy and maintain gasket stocks.

## Low maintenance and easy care

When you fabricate with Logik, you know you're providing householders with attractive, durable windows and doors that require the minimum care and attention. Capillary grooving on all inward facing frames prevents water damage and the clean, internal rebates can be kept looking their best with nothing more than warm water and a mild detergent.

## Independent certification

A BBA certificate of approval guarantees absolute security and peace of mind - for you and the installers you supply.

# INSTALLATION

HAS NEVER BEEN SIMPLER

## Why install Logik?

Logik isn't just the most advanced and sustainable PVC-U system you can fit. It's also a beautifully designed window and door system whose slim, fully bevelled profile and clean sight lines enhance properties of every type.

Available with chamfered or sculptured ovolo beads in a variety of colours, it allows for a full range of designs including casement windows, French windows, tilt and turn windows and French doors. Giving you – and your customers – one of the widest choices on the market.

## Just some of the reasons Logik is a better choice:

### A comprehensive range of ancillaries

Our extensive collection of ancillary products includes cills, angles, bay posts, extensions and adaptors. All designed to integrate with and emphasise the clean, stylish lines of your Logik window and door projects.

## A wide choice of colours and finishes

Today's householders demand more in the way of options to complete their vision of the perfect home. With White, Cream, Slate Grey, Anthracite Grey, Golden Oak, Irish Oak\* and White Ash\* all available in the Logik range, you're perfectly placed to offer the choice they're looking for.

## Improved drainage, thermal efficiency and strength

Our innovative six chamber design combines outstanding 'A+' rated thermal performance, low weight, super-efficient drainage and extraordinary strength in the slimmest of PVC-U profiles.

## Versatility

Logik can be configured to accept both 28mm and 36mm glazing thicknesses according to the specifications and requirements of your project.

## Peace of mind

Full BBA accreditation means you can recommend Logik to your customers with complete confidence it will perform at its best and look great for many years.



# LOGIK WINDOW & DOOR SYSTEM

## STYLE & COLOUR OPTIONS



**STANDARD CASEMENT WINDOWS**  
Shown in Chamfered, Anthracite Grey



**STANDARD CASEMENT WINDOWS**  
Shown in Ovolo, Cream



**FLUSH CASEMENT WINDOWS**  
Shown in Irish Oak



**TILT & TURN WINDOWS**  
Shown in Moondust Grey



**FRENCH WINDOWS**  
Shown in White Ash



**RESIDENTIAL DOORS**  
Shown in Golden Oak



**FRENCH DOORS**  
Shown in White



**ASPECT FLUSH FRENCH DOORS**  
Shown in Wooddec Sheffield Oak Alpine

**THE PERFECT  
COMPLEMENT**  
Logik S windows  
and Aspect Flush  
French doors

Logik Chamfered in Anthracite Grey





## Colours to frame the view

Like all Eurocell PVC-U products, the Logik window and door system comes with an exact colour-match guarantee. That means the colour is precisely matched to all Eurocell window, door, conservatory roof and roofline products, creating a co-ordinated, consistent look across any property.

## Up to 10-year guarantee

Logik windows and doors are guaranteed for ten years, so you can give your customers the assurance of a robust, well-designed, precision-made product that's built to last – manufactured by the UK's leading PVC-U specialist.

## FRAME COLOURS FROM STOCK



**WHITE**  
White interior



**CREAM WHITE†**  
White interior



**WHITE ASH†**  
White interior



**WHITE ASH†**  
White Ash interior



**AGATE GREY**  
White interior



**ANTHRACITE GREY**  
White interior



**ANTHRACITE GREY**  
Grey interior



**SLATE GREY\***  
White interior

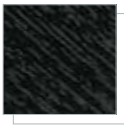

**BLACK ASH**  
White interior



**IRISH OAK†**  
White interior



**IRISH OAK†**  
Irish Oak interior

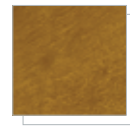

**GOLDEN OAK**  
White interior



**GOLDEN OAK**  
Golden Oak interior



**ROSEWOOD**  
White interior



**ROSEWOOD**  
Rosewood interior



**CHARTWELL GREEN†**  
White interior



**DARK RED◊†**  
White interior



**BLUE◊†**  
White interior



**OLIVE GREEN◊†**  
White interior

**32 ADDITIONAL COLOURS AND SPECIFICATIONS ARE MADE TO ORDER ON EXTENDED LEAD TIMES**

† Ovolo only \* Chamfered only ◊ Door frame only

Note: Grey base product features cool colours foil



# MAXIMUM ENERGY EFFICIENCY

FOR MINIMUM OUTLAY ON HEATING BILLS

## Increasing demand for energy efficient windows

Delivering superior energy efficiency has never been more important for the construction industry and homeowners. It's an alarming fact that our homes and buildings are responsible for almost half of the UK's carbon dioxide emissions.

Windows have an important role to play in combating energy wastage, since 20% of the heat escaping from an average home is lost through its windows\*.

## The green option you can afford

Eurocell Logik helps builders and homeowners to meet their environmental objectives - without having to pay a premium for going green. Fitting Eurocell PVC-U Thermal Inserts in Logik profiles to boost the thermal efficiency of your windows provides better value than steel alternatives. And they are made from 100% recycled material.

Plus you can use the Thermalogik outer frame system - part of the Logik family - which enables you to exceed the thermal efficiency requirements of the Building Regulations by 35%\*.

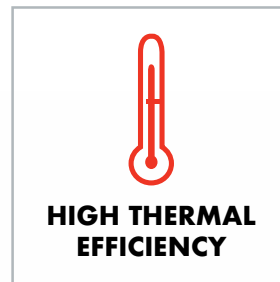
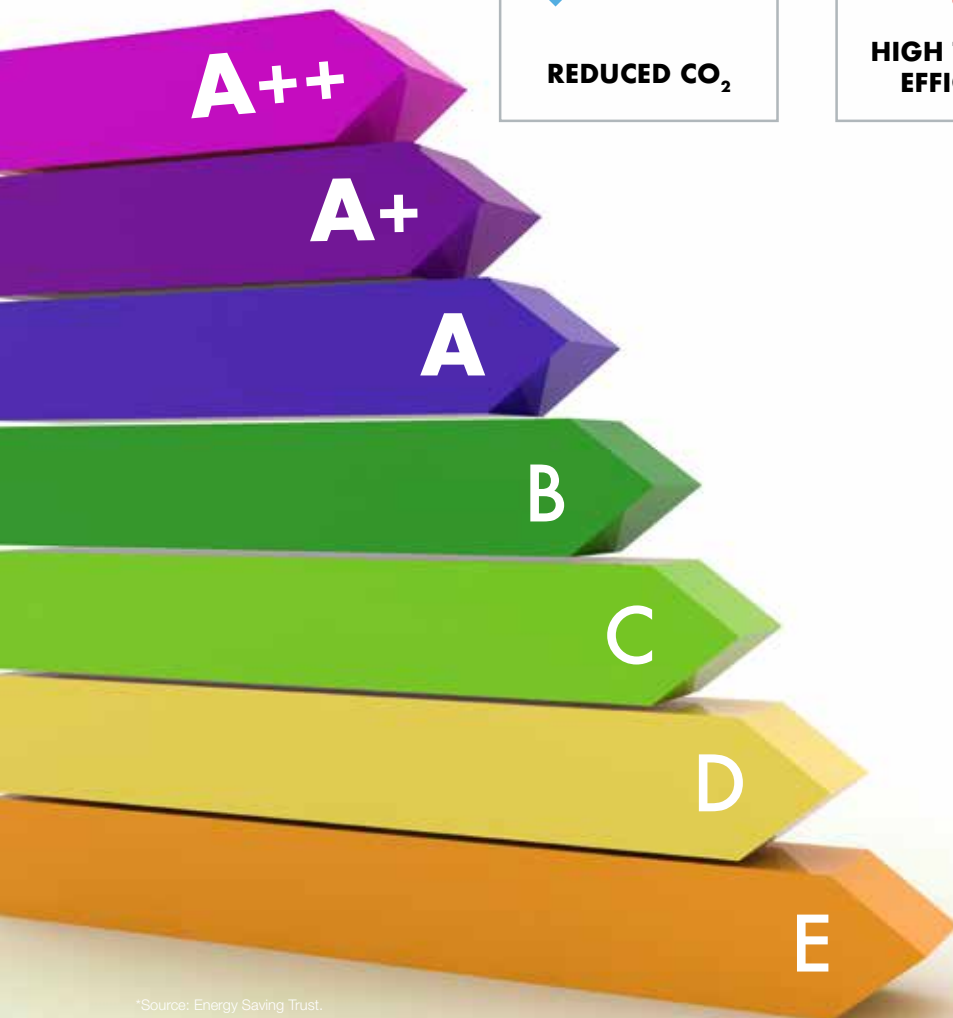

\*Source: Energy Saving Trust.



# THERMAL PERFORMANCE SPECIFICATION COMPARISON



## logik 55mm intermediate 6 chamber outerframe (EWS 7020)

Config	Glass 1 (external)	Glass 2	Glass 3 (internal)	Gas	Spacer bar	Reinforcing	WER	Energy Index	U-value
4/20/4	Pilkington Optiwhite	N/A	Pilkington AS	Argon	Swisspacer Ultimate	Thermal Insert	A+	12	1.3
4/20/4	Pilkington Optifloat	N/A	Pilkington AS	Argon	Swisspacer Ultimate	Thermal Insert	A	8	1.3

## logik 50mm slim outer frame with PVC-U Thermal inserts reinforcements (EWS 7001)

Config	Glass 1 (external)	Glass 2	Glass 3 (internal)	Gas	Spacer bar	Reinforcing	WER	Energy Index	U-value
4/12/4/12/4	Pilkington Optiwhite	Pilkington K Glass S	Pilkington K Glass S	Argon	SuperSpacer Premium	Thermal Insert	A++	20	1.0
4/20/4	SG Diamant	N/A	SG Planitherm Total +	Argon	Swisspacer Ultimate	Thermal Insert	A+	13	1.3
4/20/4	Clearlite	N/A	AGC Planibel A	Argon	Swisspacer Ultimate	Thermal Insert	A	1	1.5

## logik 60mm standard outer frame with PVC-U Thermal inserts reinforcements (EWS 7021 with EWS 821P)

Config	Glass 1 (external)	Glass 2	Glass 3 (internal)	Gas	Spacer bar	Reinforcing	WER	Energy Index	U-value
4/12/4/12/4	SG Diamant	SG Planitherm Total +	SG Planitherm Total +	Argon	SuperSpacer Premium	Thermal Insert	A+	16	1.0
4/20/4	SG Planiclear	N/A	SG Planitherm Total +	Argon	Swisspacer Ultimate	Thermal Insert	A	8	1.3
4/20/4	Pilkington Optiwhite	N/A	Pilkington K Glass	Argon	SuperSpacer Premium	Thermal Insert	A	1	1.5
4/20/4	SG Planiclear	N/A	SG Planitherm Total +	Argon	Aluminium Spacer	Thermal Insert	B	-4	1.5
4/20/4	Pilkington Optifloat	N/A	Pilkington K Glass	Argon	SuperSpacer Premium	Thermal Insert	B	-4	1.5
4/20/4	SG Planiclear	N/A	SG Planitherm Total +	Air	Aluminium Spacer	Thermal Insert	C	-17	1.6
4/20/4	Pilkington Optifloat	N/A	Pilkington K Glass	Air	SuperSpacer Premium	Thermal Insert	C	-15	1.7

## logik 60mm standard outer frame with standard steel reinforcements (EWS 7021)

Config	Glass 1 (external)	Glass 2	Glass 3 (internal)	Gas	Spacer bar	Reinforcing	WER	Energy Index	U-value
4/12/4/12/4	SG Planiclear	SG Planitherm Total +	SG Planitherm Total +	Argon	Thermabar	Full Steel	A	7	1.1
4/20/4	SG Diamant	N/A	SG Planitherm Total +	Argon	SuperSpacer Premium	Standard Steel	A	3	1.4
4/20/4	Pilkington Optiwhite	N/A	Pilkington K Glass	Argon	SuperSpacer Premium	Standard Steel	C	-5	1.6
4/20/4	SG Planiclear	N/A	SG Planitherm Total +	Argon	Aluminium Spacer	Standard Steel	C	-11	1.6
4/20/4	Clearlite	N/A	AGC Planibel A	Air	Thermabar	Standard Steel	C	-20	1.7

Further configurations available

# THE SUSTAINABLE CHOICE

MADE & RECYCLED IN THE UK



## Closed loop recycling process

PVC-U is a highly sustainable product, robust enough to be recycled and repurposed up to 10 times without its quality or performance deteriorating. At our recycling plants in Derbyshire and Selby, we process over 2.4 million PVC-U window frames per year. Once recycled it is used to create a variety of new products, from thermal inserts to window systems.

More and more of products contain recycled material meaning that we are able to reuse almost 100% of our production waste. Wherever possible we offer a 'closed loop' service, re-engineering the PVC-U taken from old frames to make new windows, doors and building products for the same supplier. The process uses less energy and gives customers a high performing and more efficient product.



REMOVE END OF LIFE WINDOWS



COLLECT USED FRAMES



SHRED, SORT, GRANULATE & MICRONISE PVC-U

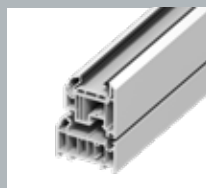

EXTRUDE NEW PVC-U PROFILES



FABRICATE NEW WINDOWS



INSTALL NEW WINDOWS



## We'll collect

We offer a regional collection service throughout the UK via a dedicated fleet of vehicles ranging from 44 tonnes to 7.5 tonne, designed to collect post-industrial and post-consumer waste helping our trade customers avoid costly landfill charges. With a network of sites strategically placed throughout the UK, waste is bulked up and transported to one of our two, state of the art, processing facilities in the UK.

As we are registered waste carriers we provide the legal documentation ensuring full compliance with the Environmental Protection (Duty of Care) Regulation 1991. Our systems also allow us to provide evidence of full traceability of materials from collection at source, through the production process, to delivery to the customer meaning we can demonstrate that all the waste we receive is recycled to its full potential.



**MADE & RECYCLED  
IN THE UK**

## Future Homes Report Findings

With a rapidly changing and evolving society that uses an increasing amount of constantly advancing technology, and has attitudes that are significantly shifting towards issues such as sustainability, the environmental impact of buildings and building design, the construction sector faces a challenge when it comes to ensuring the homes they build are homes that consumers want to live in. To explore buildings of the future and gain valuable insight to share with the wider industry, Eurocell surveyed 1,000 25-40-year olds to investigate their views.

Respondents were asked questions on a wide range of issues including their attitudes towards sustainability credentials in future homes. Interestingly 49% of respondents said they would be more likely to buy or rent an 'eco-friendly' home containing sustainable building materials, only 24% would be willing to pay more money for eco-features and 22% of respondents said the use of recycled and sustainable building products was an appealing feature to have in their next home. These research findings demonstrate the importance of sustainability to consumers and the need for more of them to be included on new building and replacement housing projects.

## The latest Eurocell sustainability awards:



# TECHNICAL INFORMATION

## MINIMUM & MAXIMUM SIZES

### CASEMENTS

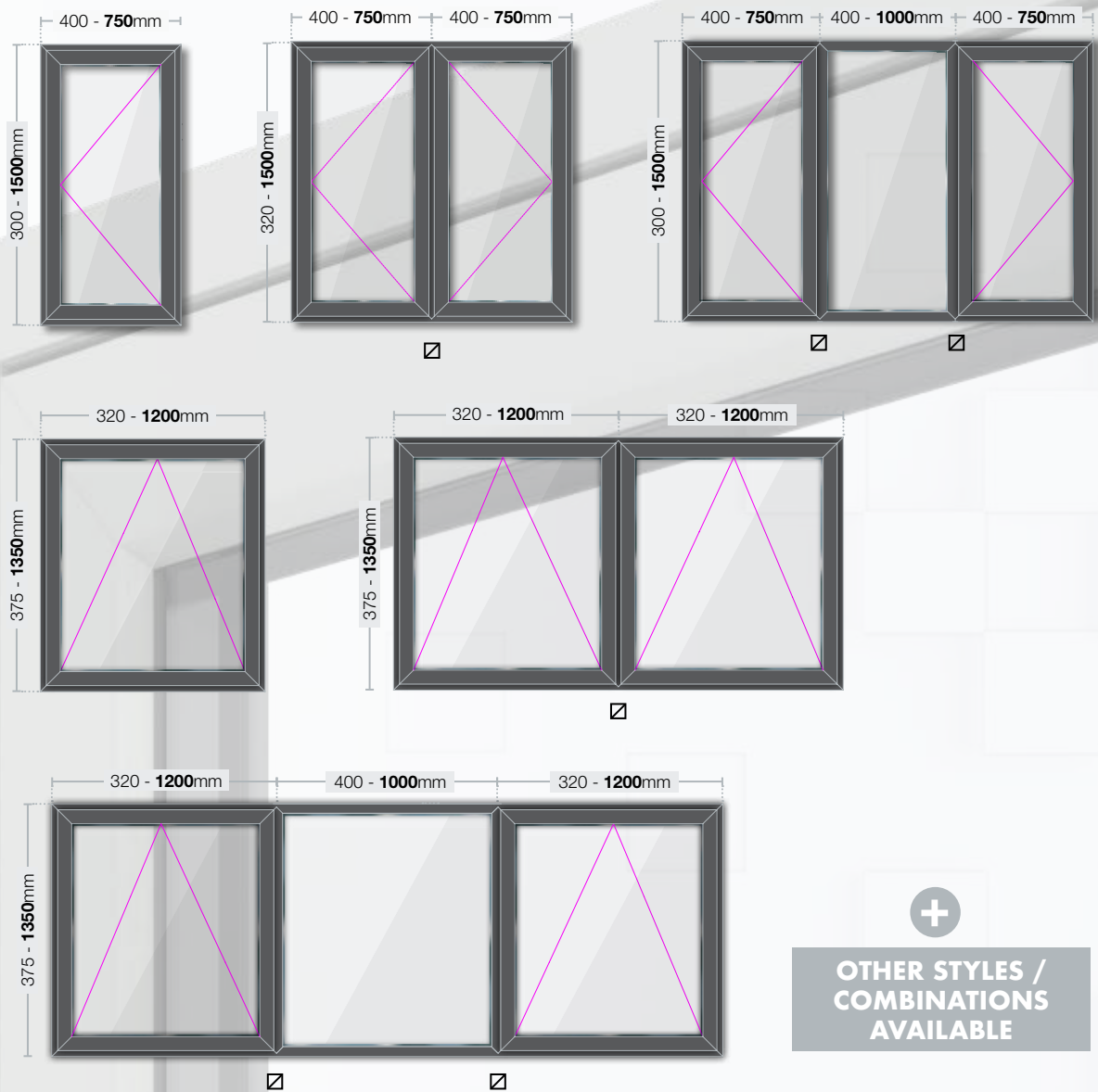

OTHER STYLES /  
COMBINATIONS  
AVAILABLE

Sizes shown **do not** include cill.

For sizes outside min/max dimensions please contact Eurocell Technical department. Ensure suitable hardware is used that is capable of withstanding the sash weight.

All Sizes shown: MINIMUM - **MAXIMUM** in mm

**FIXED**



**EGRESS\***

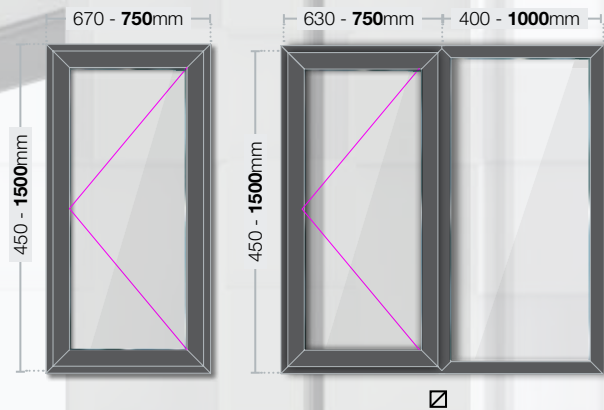

**RESIDENTIAL DOORS**



**FRENCH DOORS**

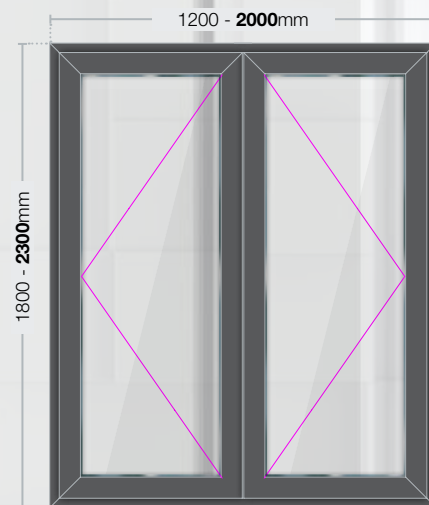

**KEY**

☒ Butt joint may be required depending on location within the UK, height of installation above ground level and size. Contact Eurocell Technical department to carry out a windload calculation if in doubt.

\* Basic frame sizes to give 450mm clear opening. Different egress hinges give different results. Check against your own hardware to ensure these dimensions are correct. Eurocell cannot be held responsible for variations in hardware geometry.



# TECHNICAL INFORMATION

## FLUSH SASH WINDOWS

### Flush Sash with Chamfered Frame

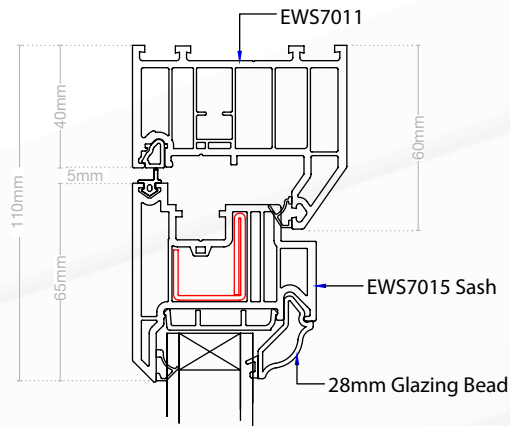

For aesthetics, it is recommended to use dummy sashes

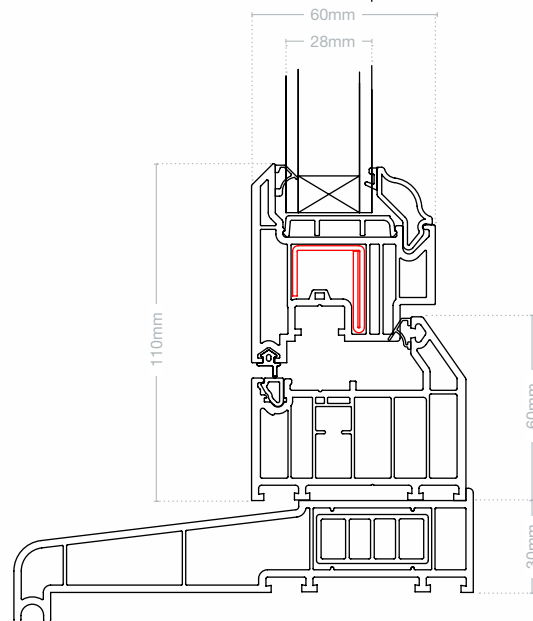
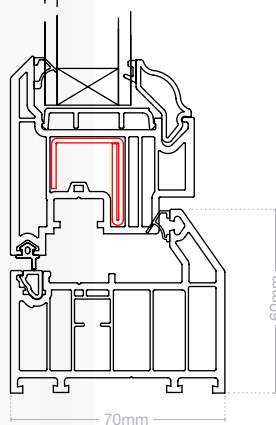
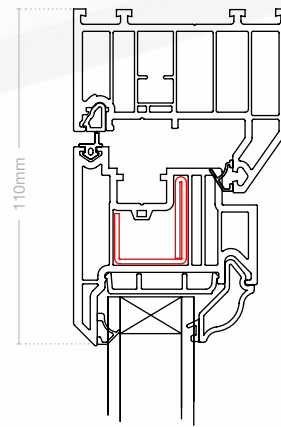
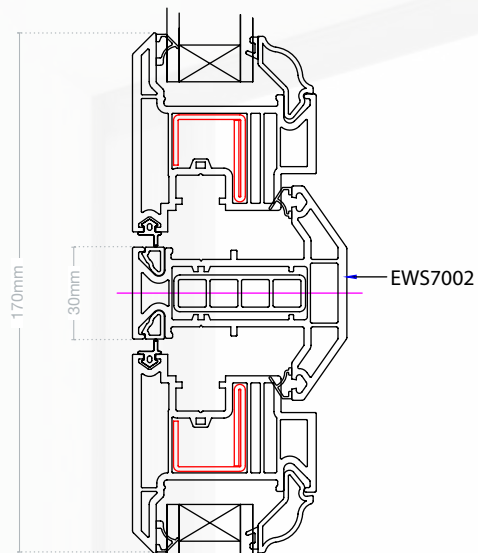
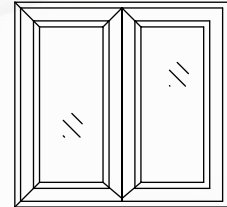

HORIZONTAL CROSS SECTION

VERTICAL CROSS SECTION

All dimensions approximate.

## Flush Sash with Ovolo Frame

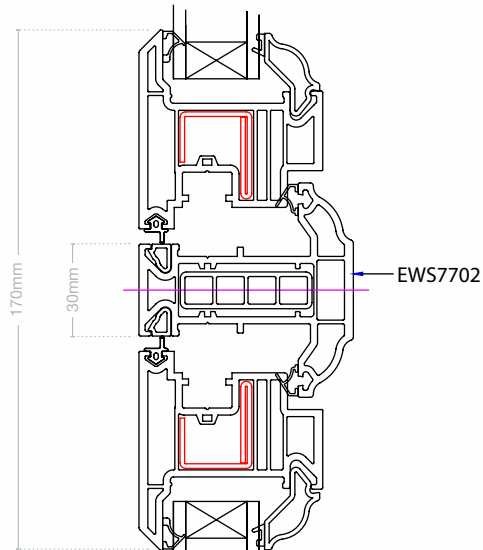
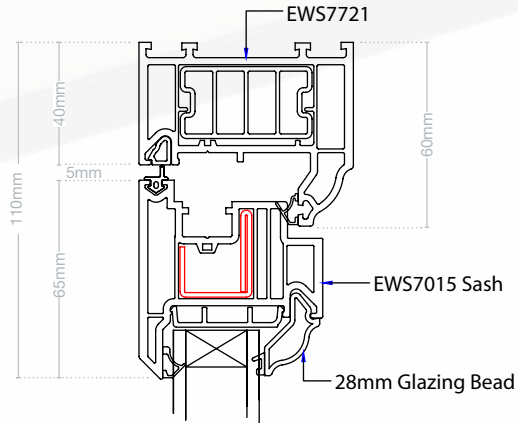

**HORIZONTAL CROSS SECTION**

For aesthetics,  
it is recommended  
to use dummy sashes

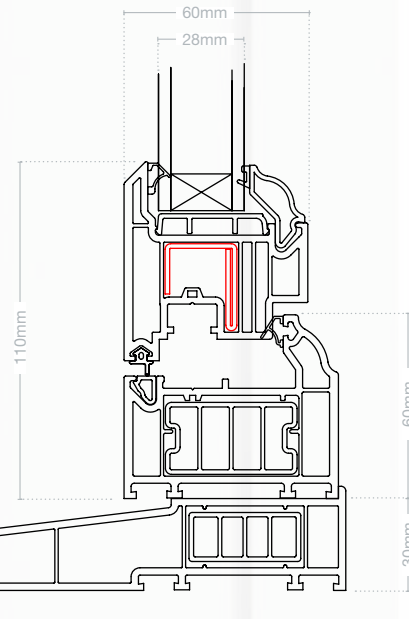
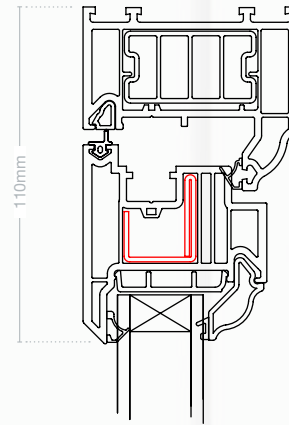
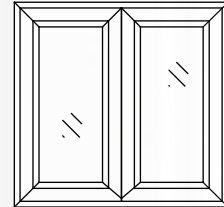

**VERTICAL CROSS SECTION**

All dimensions approximate.

# TECHNICAL INFORMATION

## CASEMENT WINDOWS

Frame / dimension	Dim X	Frame / dimension	Dim Y	Frame / dimension	Dim Z
Thermalogik outer frame (EWS 7001) with sash T (EWS 7005)	97mm	Sash T (EWS 7005) with transom Z (EWS 7003)	117mm	Thermalogik outer frame (EWS 7001)	50mm
Main frame (EWS 7020) with sash T (EWS 7005)	102mm	Sash T (EWS 7005) with intermediate transom Z (EWS 7023)	132mm	Slim outer frame (EWS 7020)	55mm
Main frame (EWS 7021) with sash T (EWS 7005)	107mm			Main frame (EWS 7021)	60mm
Main frame (EWS 7011) with sash T (EWS 7005)	107mm			Main frame (EWS 7011)	60mm
Large main frame (EWS 7006) with sash T (EWS 7005)	122mm			Large main frame (EWS 7006)	75mm

logik™

Chamfered and Ovolo  
window and door system

## OUTWARD OPENING, INWARD GLAZED

Aluminium  
Reinforcement option

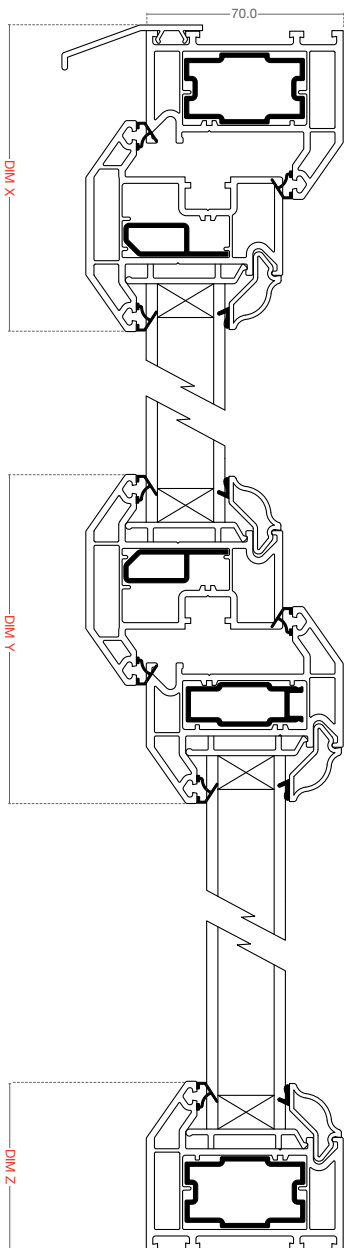

Steel  
Reinforcement option

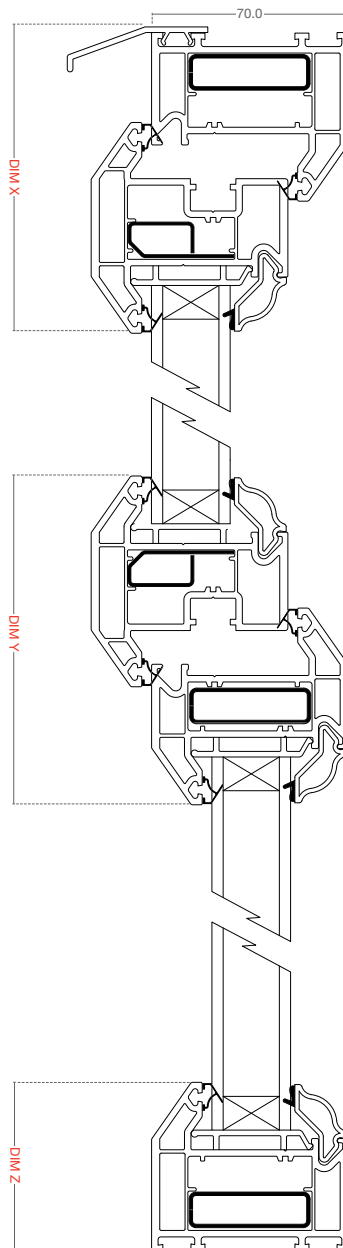

PVC-U Thermal Inserts  
Reinforcement option

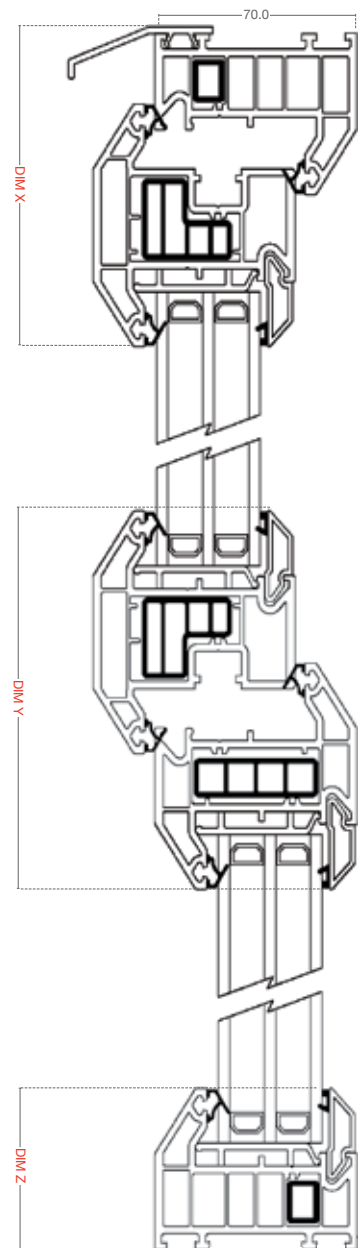



# TECHNICAL INFORMATION

## RESIDENTIAL DOORS

Frame / dimension	Dim X	Frame / dimension	Dim Y	Frame / dimension	Dim Z
Main frame (EWS 7011) with door sash Z (EWS 7018)	137mm	Midrail (EWS 7002)	70mm	Low threshold (EWS 7545A and 7546A)	119mm
Main frame (EWS 7021) with door sash Z (EWS 7018)	137mm	Midrail (EWS 7022)	85mm	Thermalogik outer frame (EWS 7001)	127mm
Large main frame (EWS 7006) with door sash Z (EWS 7018)	152mm	Midrail (EWS 7009)	115mm	Main frame (EWS 7020)	132mm
				Main frame (EWS 7021)	137mm
				Main frame (EWS 7011)	137mm
				Large main frame (EWS 7006)	152mm



**INWARD OPENING, INWARD GLAZED**

**Vertical cross section**  
With aluminium reinforcing

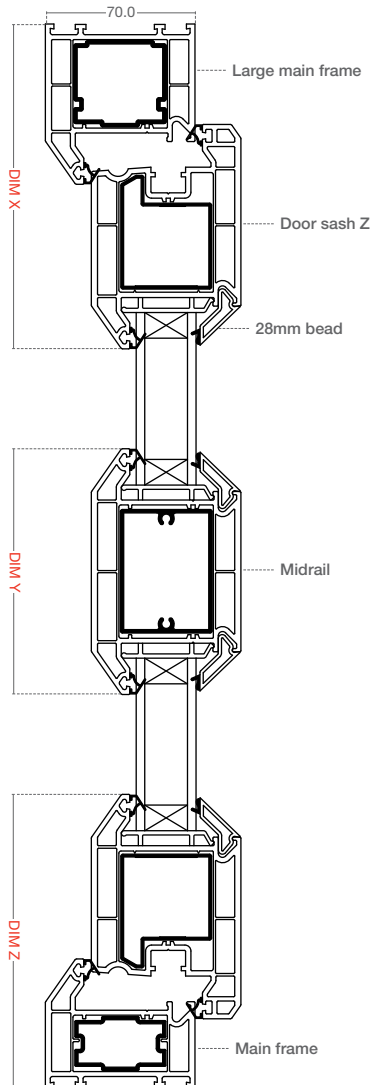

**Low threshold**  
Threshold option

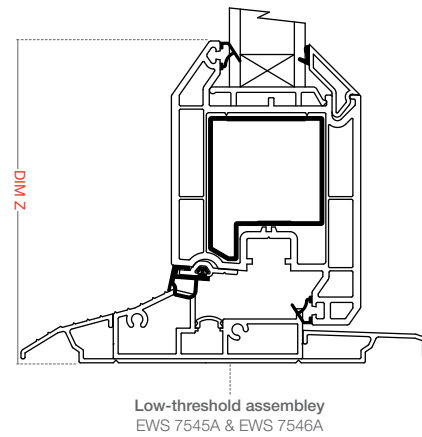

**Large main frame**  
Threshold option

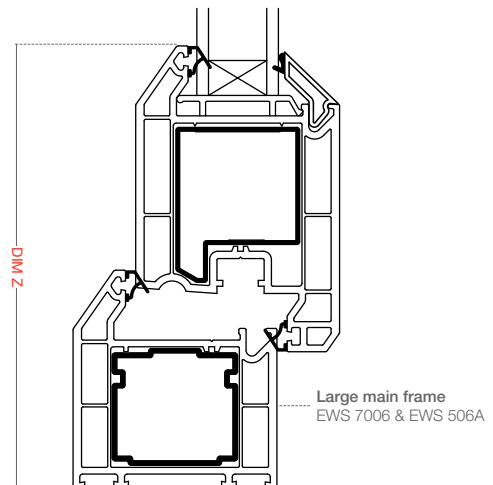

# TECHNICAL INFORMATION

## SYSTEM COMPONENTS

### MAIN PROFILES - CHAMFERED

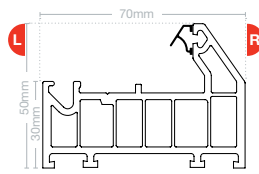

Slim outer frame  
**EWS 7001**  
Reinforcing EWS 800P

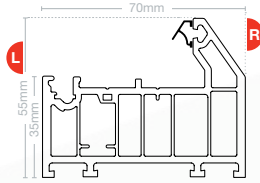

Intermediate outer frame  
**EWS 7020**  
Reinforcing EWS 800P

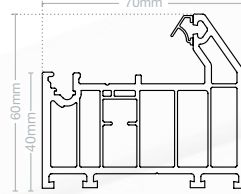

Main frame  
**EWS 7011**

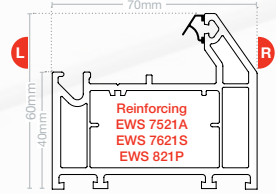

Main frame  
**EWS 7021**

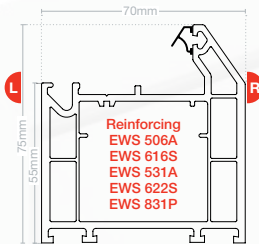

Large main frame  
**EWS 7006**

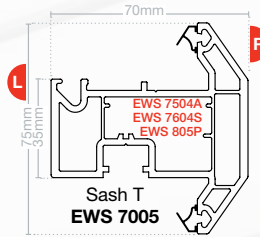

Sash T  
**EWS 7005**

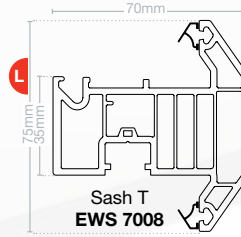

Sash T  
**EWS 7008**

Reinforcing EWS 800P

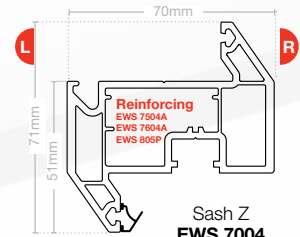

Sash Z  
**EWS 7004**

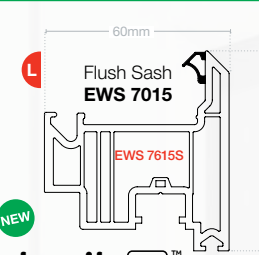

Flush Sash  
**EWS 7015**

logik S

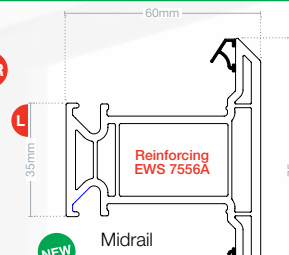

Midrail  
**EWS 7056**

For use with Logik S Flush Sash

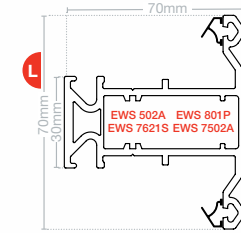

Transom T  
**EWS 7002**

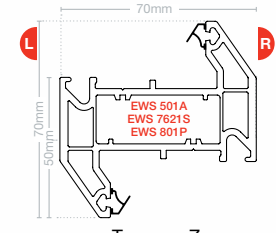

Transom Z  
**EWS 7003**

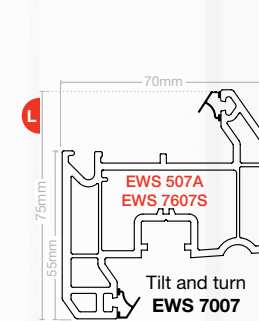

Tilt and turn  
**EWS 7007**

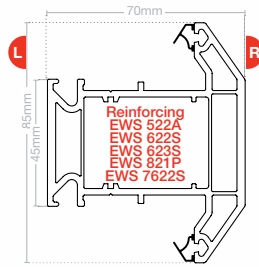

Intermediate transom T  
**EWS 7022**

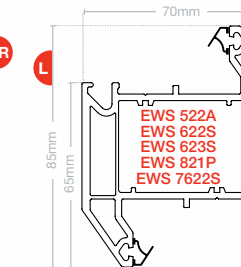

Intermediate transom Z  
**EWS 7023**

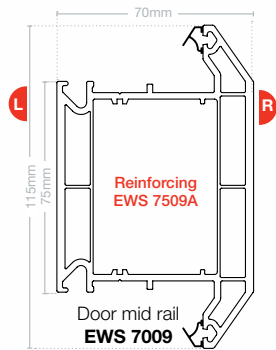

Door mid rail  
**EWS 7009**

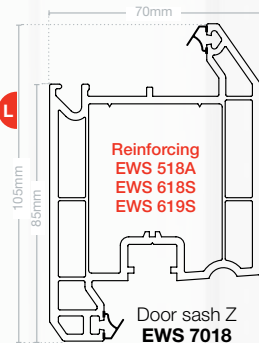

Door sash Z  
**EWS 7018**

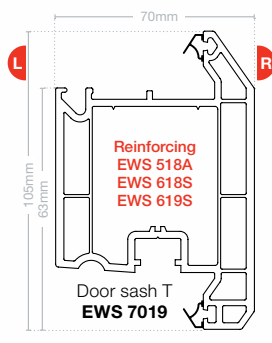

Door sash T  
**EWS 7019**

### CILL EXTENDERS

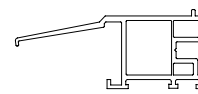

Cill extender  
(for AC 125, 150, 180 & 225)  
**EWS 118**

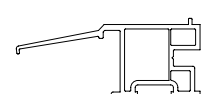

Cill extender  
(for AS 85)  
**EWS 1180**

# logik™

## Chamfered and Ovolo window and door system

# logik S™

## Flush Sash window system

### MAIN PROFILES - OVOLO

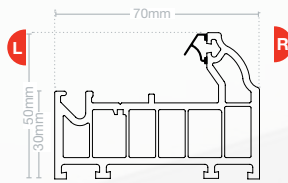

Thermalogik frame  
**EWS 7701**  
Reinforcing EWS 800P

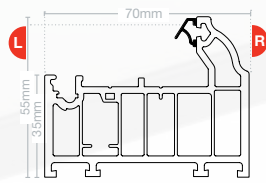

Slim outer frame  
**EWS 7720**  
Reinforcing EWS 800P

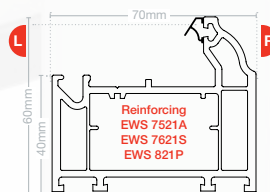

Main frame  
**EWS 7721**

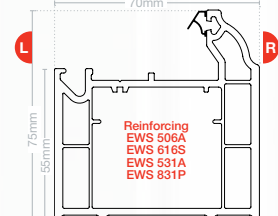

Large main frame  
**EWS 7706**

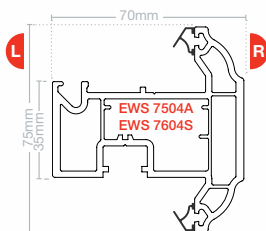

Sash T  
**EWS 7705**

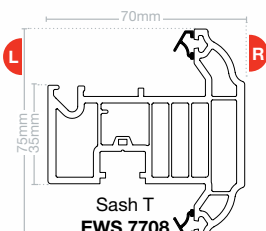

Sash T  
**EWS 7708**  
Reinforcing EWS 800P

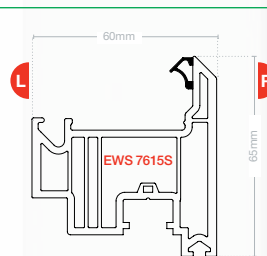

**NEW** Flush Sash  
**EWS 7015**

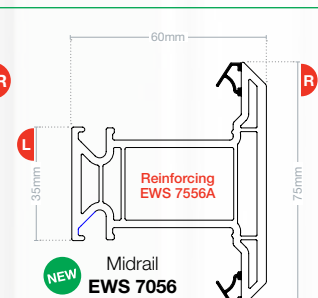

**NEW** Midrail  
**EWS 7056**  
For use with Logik S Flush Sash

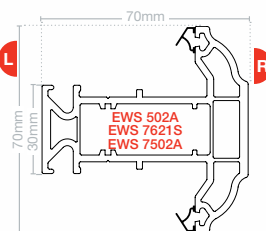

Transom T  
**EWS 7702**

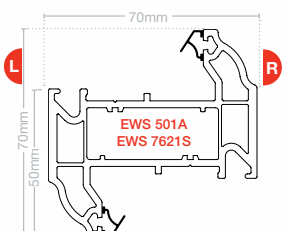

Transom Z  
**EWS 7703**

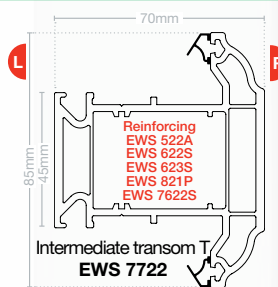

Intermediate transom T  
**EWS 7722**

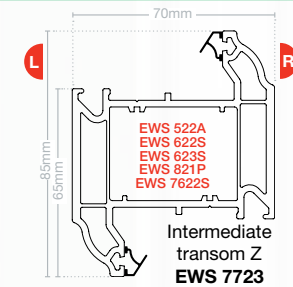

Intermediate transom Z  
**EWS 7723**

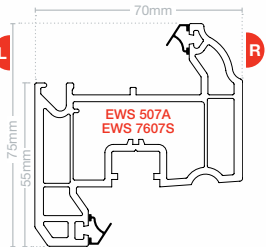

Tilt and Turn  
**EWS 7707**

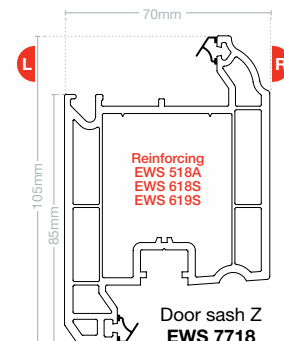

Door sash Z  
**EWS 7718**

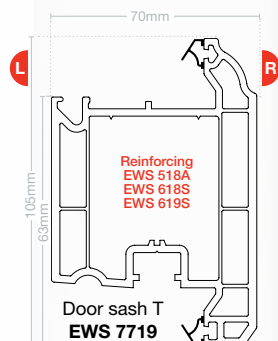

Door sash T  
**EWS 7719**

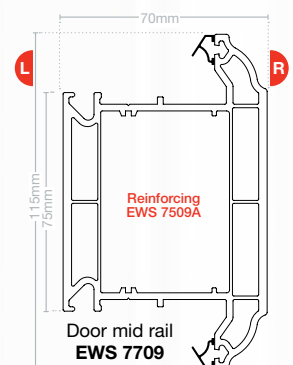

Door mid rail  
**EWS 7709**

### CILLS

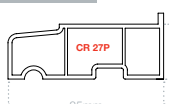

85mm A type cill  
**AS 85**

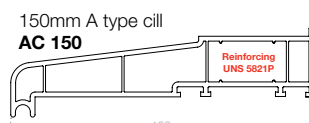

150mm A type cill  
**AC 150**  
Reinforcing UNS 5821P

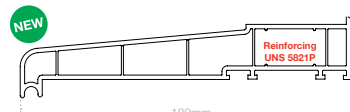

**NEW** 180mm A type cill  
**AC 180**  
Reinforcing UNS 5821P

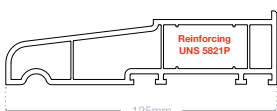

125mm A type cill  
**AC 125**  
Reinforcing UNS 5821P

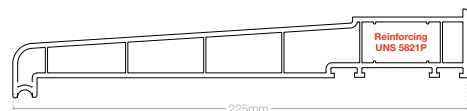

225mm A type cill  
**AC 225**  
Reinforcing UNS 5821P

**KEY** Left face **L** Right face **R**



# TECHNICAL INFORMATION

## SYSTEM COMPONENTS

### CILL MOULDINGS & ANCILLARIES

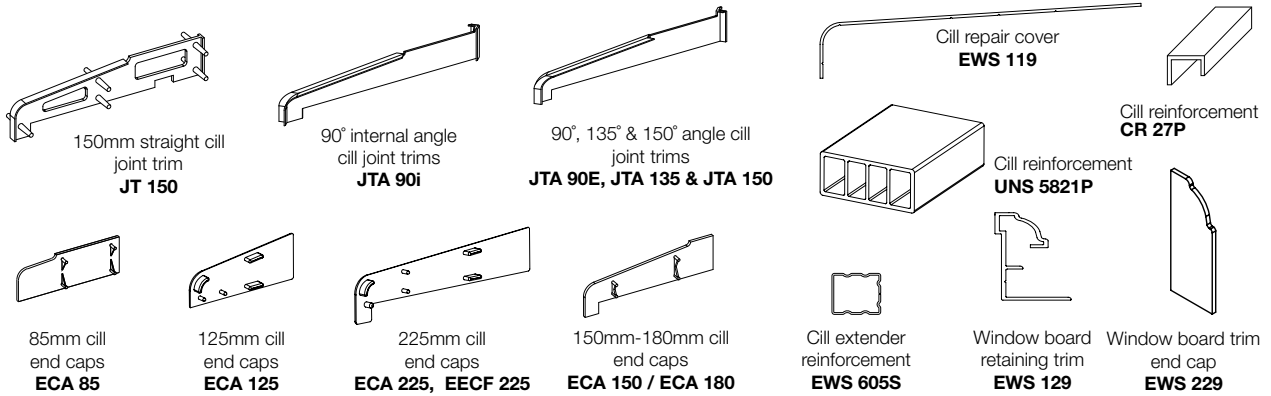

### ANCILLARIES, BEADS & GASKETS

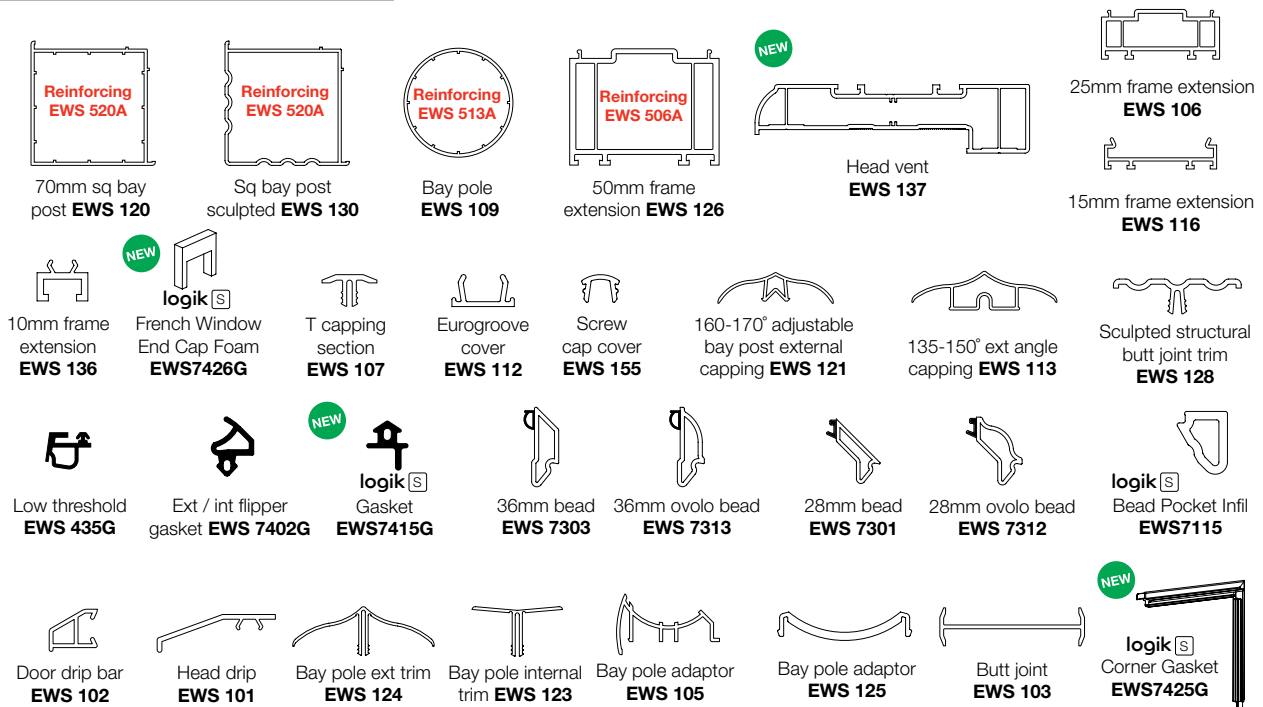

### MOULDINGS



# logik™

## Chamfered and Ovolo window and door system

# logik S™

## Flush Sash window system

### PVC-U LOW THRESHOLD AND ALUMINIUM RAMPS

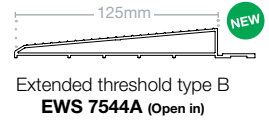
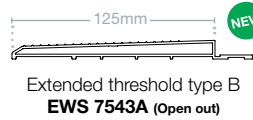
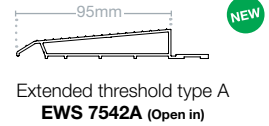
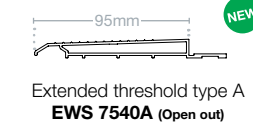
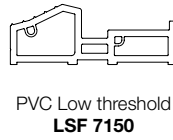
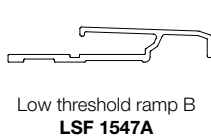
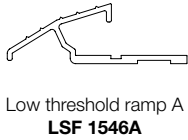

### STEEL COMPONENTS

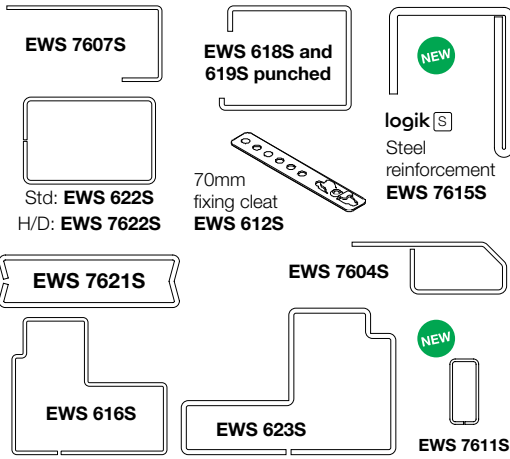

### DEC FEATURES

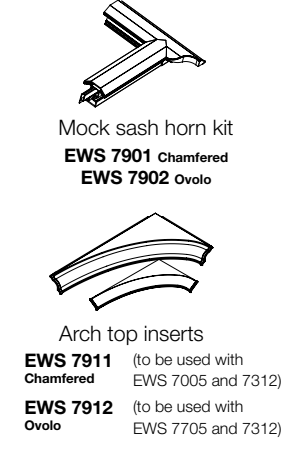

### PVC-U THERMAL INSERTS

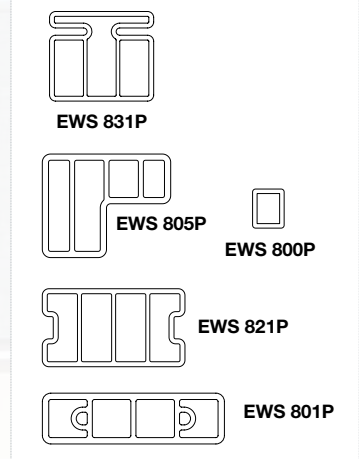

### ALUMINIUM COMPONENTS

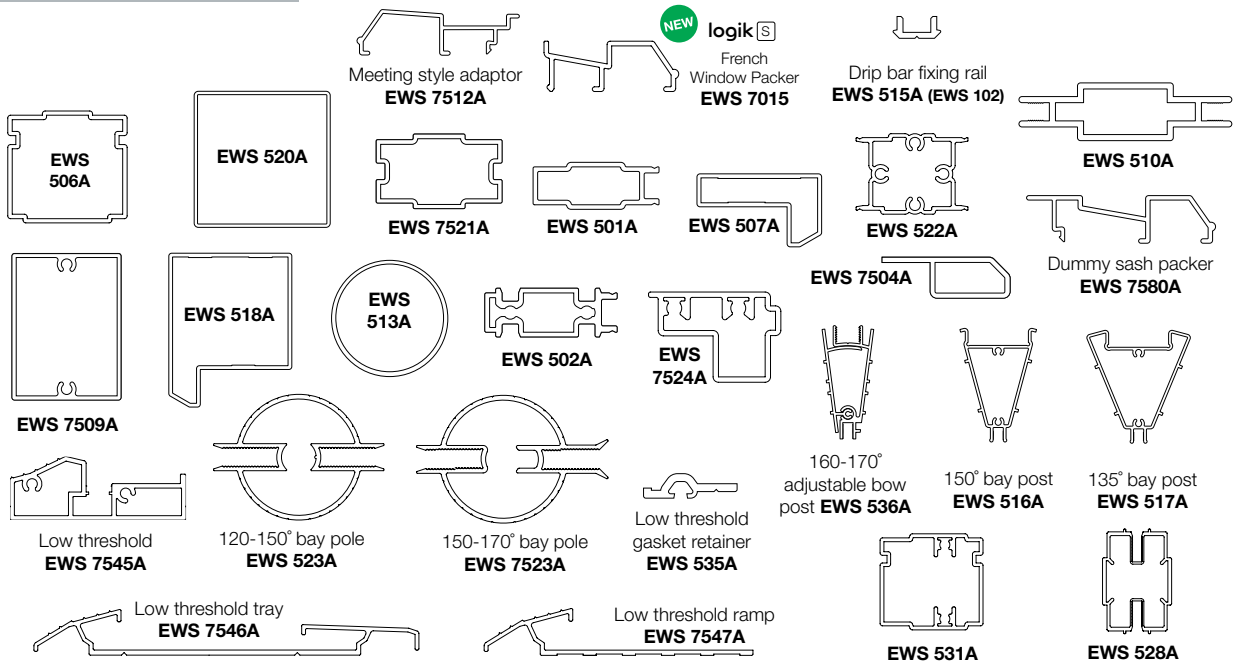

# CASE STUDIES



**Client:** Morris Homes

**Project:** Zero carbon village

Eurocell Logik triple-glazed windows and fully recycled cavity closers were specified by Morris Homes on the UK's largest zero carbon village in Peterborough.

The development of 295 zero-carbon homes was designed to reduce energy emissions by 100% compared to an equivalent sized standard housing development.

The windows achieved a U-value of 0.8W/m<sup>2</sup>K, helping the properties meet the carbon reduction requirements of UK Building Regulations up to the 2016 zero carbon deadline.

Logik windows, Cavalok cavity closers and other energy saving measures were incorporated into the design, and have contributed to the Vista properties requiring 74% heating per square metre, compared to the average UK home.

Homebuyers will not only feel these benefits in terms of more comfortable and healthier homes, but will delight in the fact that they save around £310 off their annual energy bills.

Morris Homes has demonstrated how sustainable developments, often perceived to be expensive, are now a real alternative for all developers, with two bedroom properties at the Vista site starting from just £139,000.

“Eurocell windows in Grey created exactly the right contemporary appeal for Morris Homes. The specifiers liked the slim profile of the frames because it lets in the maximum amount of natural daylight and that means the homebuyers don't even notice that they have been specified to achieve zero carbon.”

**Simon Bingham**  
**Contract Manager**



## Project: BRE Smart Home Refurbishment

BRE Exemplar Project Partner Eurocell and its approved fabricator Nationwide Windows have worked with the Building Research Establishment (BRE) and British Gas to refurbish SmartHome in Garston, Watford.

Logik windows were just one of the Eurocell products specified for the refurbishment as they provide high levels of thermal efficiency, sustainability and value for money.

The refurbished 'House of the Future' showcases latest products and technologies with the aim of helping households to reduce energy consumption through sustainable refurbishment.

Calculations indicate that replacing the timber windows with energy efficient PVC-U windows from Eurocell will provide greater air tightness as well as improving U-values, aiming to improve the three-bedroom home's energy efficiency from an EPC (Energy Performance Certificate) rating of E to a B or an A.

SmartHome, formerly the Integer House (which stands for Intelligent and Green), will be used as a reference

point by many housing associations, local authorities and architects. The building has already informed a generation of house designers as far as China, and will inspire the next generation of housing experts.

All new windows incorporate the Eurocell PVC-U Thermal Inserts to improve the frames thermal performance and, being made from 100% post-consumer recycled PVC-U, provide a sustainable method of dealing with end-of-life PVC-U frames from refurbishment projects. Eurocell operates the UK's largest post-consumer PVC-U recycling facility near to its headquarters in Derbyshire.

"SmartHome will highlight how refurbishing existing buildings can be an affordable and a highly effective way of reducing energy bills and improving comfort for residents."

**John O'Brien**  
Principal Consultant BRE





All together better

For more information about **logik** windows and door system from Eurocell, call our customer services team on **0800 988 3047**, or visit **[eurocell.co.uk/logik](https://eurocell.co.uk/logik)**

Eurocell plc, High View Road, Alfreton, Derbyshire DE55 2DT



**[eurocell.co.uk](https://eurocell.co.uk)**