



neaco

Modular Aluminium Decking





Contents

Page

Why Choose Neaco?	4
Why Choose Aluminium Decking?	5
The Benefits of Modular Decking	6-7
Modular Decking	8-15
Neatdek	10-11
Neatdek HW	12-13
Neatdek 188	14-15
Maintenance Flooring	16-21
Flat Bar	18-19
NI Bar	20-21
Solar Shading	22-27
Louvredek	24-25
Brise Soleil	26-27
Project Portfolio	28-29
Testimonials	30-31

WHY CHOOSE NEACO?

- | Long-established company (founded in 1972) with decades of manufacturing experience
- | British manufacturer committed to the highest standards of precision engineering
- | 52,500 square foot manufacturing facility in North Yorkshire
- | Comprehensive design and technical expertise to back manufacturing excellence
- | Able to design and supply bespoke solutions tailored to exact requirements
- | Full turnkey solution (from design to installation) with support at every step of the process
- | Decking manufactured from sustainable materials
- | Wide range of products to complement decking, including balustrades and balconies
- | All products backed by a 25-year guarantee

We're in good company...

Why choose aluminium decking?

| **Non-Combustible**

All decking is A1-A2 Fire Rated and fully compliant with the latest regulations

| **Extremely Durable**

Our aluminium flooring has a design life of 60+ years

| **Low Risk of Slip**

Superior slip resistance in both wet and dry conditions

| **Lightweight**

One third the weight of steel, aluminium is light and easy to handle, so it saves on manpower

| **Environmentally Friendly**

Made from 100% recyclable material

| **Maintenance-Free**

Our decking is virtually maintenance-free

| **High-End Aesthetic**

Whether mill finished or colour coated, our decking's high-end aesthetic will complement any design

| **Corrosive-Free**

Aluminium will, with time, generate a protective oxide film coating giving excellent resistance to corrosion

Over the years, our products have been featured at numerous award-winning projects and iconic locations, from Wimbledon to Windsor Castle. Leading architects, designers, developers and contractors choose Neaco, safe in the knowledge that we bring outstanding pedigree in architectural specification.

What is modular decking?

We manufacture a range of modular decking solutions that are fully compliant with all building and fire regulations. Our range of pre-engineered flooring units are delivered to site as required and assembled with discreet fixings to cover the exact surface area. This minimises installation costs and time on site.

The benefits of modular decking...

| **Quick Installation**

Installation is extremely quick – less than 30 minutes per square metre

| **Bespoke Solution**

Our modular decking is made to the exact requirements of the project so bespoke panel sizes, cut-outs and unique shapes can be catered for without compromising the structural integrity of the product

| **Superior Spanning**

Modular construction results in superior spanning capability, which significantly reduces the number of structural supports needed

| **Reduces the Risk of Delays**

Delays on site caused by uncontrollable factors, such as the weather, can be avoided as the majority of work is carried out in our bespoke manufacturing facility in North Yorkshire

| **Reduces Disruption**

As the installation is so quick, noise, dust and light pollution are greatly reduced on site. This is ideal for refurbishment projects with existing residents

A photograph of a modern building with a glass facade. In the foreground, there is a balcony with a modular decking system. The decking consists of parallel metal slats with small circular supports. The building's glass reflects the sky and other buildings. A green rectangular box with white text is overlaid on the image.

MODULAR DECKING

Neatdek • Neatdek HW • Neatdek 188

Our acclaimed modular decking range includes three standard profiles, each precision engineered from aluminium. Combining load-bearing strength with efficient drainage, the systems are extremely versatile and ideal for a wide range of architectural applications. We also manufacture a range of Pedestal and Support Solutions; please get in touch for more information.



SUITABLE APPLICATIONS

Balcony flooring
Garden decking
External terrace decking
Bridge decking
Mezzanine floors
Maintenance galleries
Roof access walkways
Stair treads
Ramp access systems
Staging

MODULAR DECKING: NEATDEK

Neatdek is an A1-A2 Fire Rated decking system made from 100% aluminium. Available with either 5mm or 8mm gaps, it enables water to drain freely away while the ribbed surface allows for exceptional slip resistance and the modular construction means that market-leading spanning capabilities can be achieved.

NEATDEK WITH INSERT

Neatdek is available with the option of inserts. This provides a closed solution, which offers excellent privacy and negates the need for soffits.

Surface contact area: 100%



- | **Fire Rating:** A1 Fire Rated (mill finished) and A2 Fire Rated (colour coated)
- | **Modular Solution:** Manufactured in multiple modules to be combined on site
- | **Bespoke:** Manufactured to your exact requirements
- | **Spanning Capabilities:** Market-leading capabilities
- | **Slip Resistance:** Categorised as 'low risk of slip' in both wet and dry conditions
- | **Drainage:** Free draining without inserts and directional drainage with inserts
- | **Surface Contact Area:** 74% (8mm gap) and 84% (5mm gap)
- | **Free Air Rate:** 25% (8mm gap) and 16% (5mm gap)
- | **Technical Data Sheet:** Available upon request

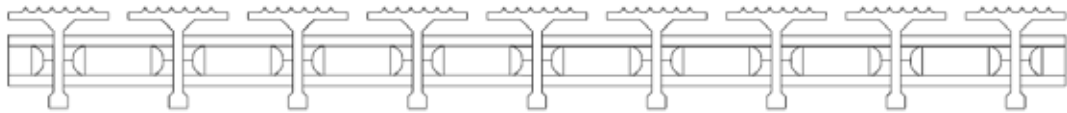

Colour Options

Our systems are available with a durable coating that features curing agents selected for their excellent hard wearing properties, UV resistance and protection against weathering. Available in a choice of standard colours, they provide a more natural and traditional aesthetic where required. Alternatively, we can coat to any required RAL colour.

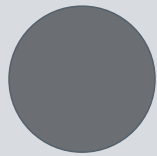

Anthracite Grey
RAL 7016

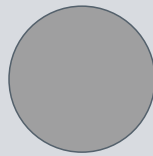

Dusty Grey
RAL 7037

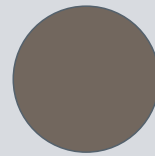

Chocolate Brown
RAL 7017

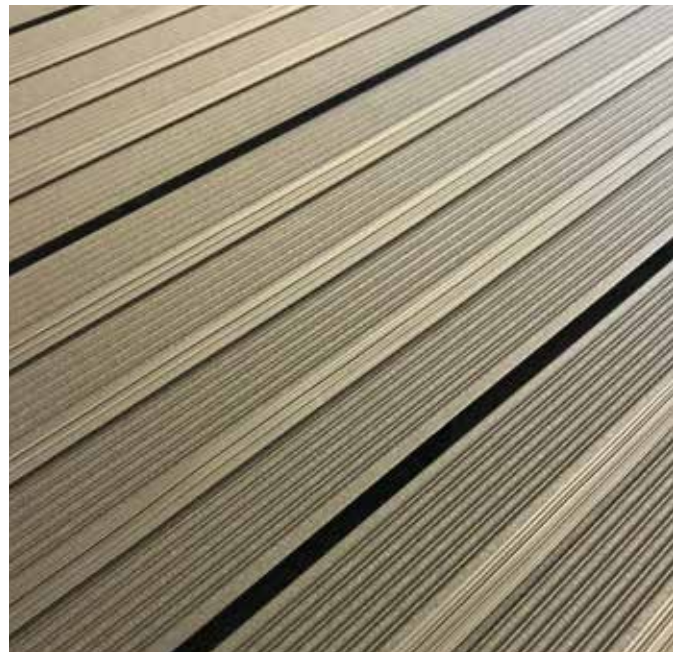

MODULAR DECKING: NEATDEK HW

Neatdek HW is a closed decking system that incorporates discreet drainage channels to allow for directional drainage. This design also provides a completely private solution, making it a popular choice for elevated floors such as balconies.



- | **Fire Rating:** A1 Fire Rated (mill finished) and A2 Fire Rated (colour coated)
- | **Modular Solution:** Manufactured in multiple modules to be combined on site
- | **Bespoke:** Manufactured to your exact requirements
- | **Spanning Capabilities:** Market-leading capabilities
- | **Slip Resistance:** Categorised as 'low risk of slip' in both wet and dry conditions
- | **Drainage:** Directional drainage via discreet drainage channels
- | **Surface Contact Area:** 90%
- | **Free Air Rate:** 0%
- | **Technical Data Sheet:** Available upon request

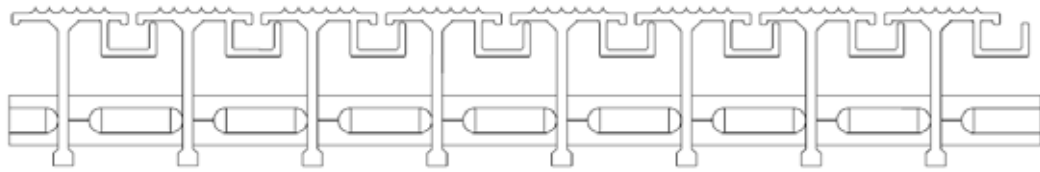
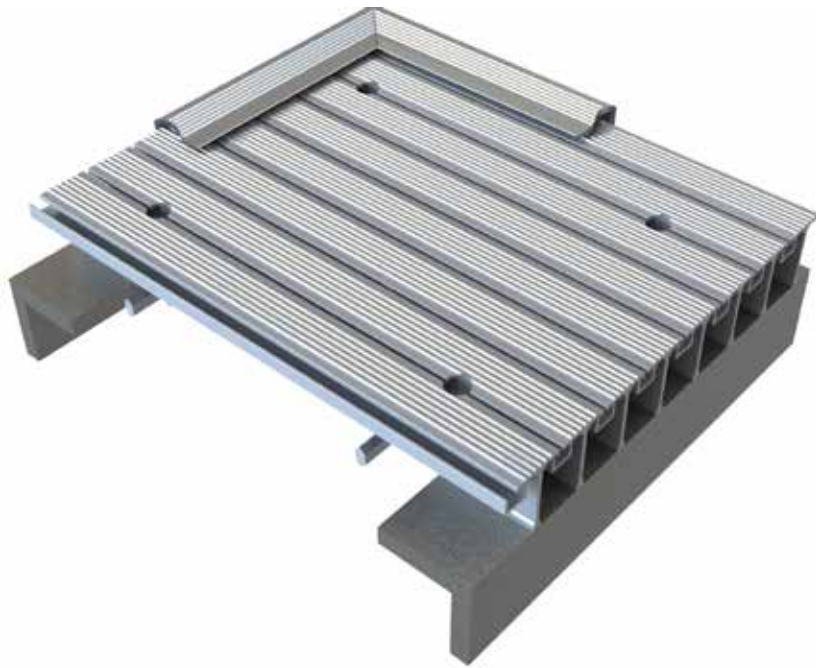

Colour Options

Our systems are available with a durable coating that features curing agents selected for their excellent hard wearing properties, UV resistance and protection against weathering. Available in a choice of standard colours, they provide a more natural and traditional aesthetic where required. Alternatively, we can coat to any required RAL colour.

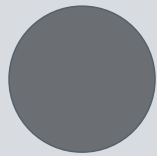

Anthracite Grey
RAL 7016

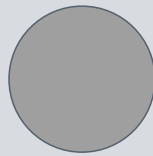

Dusty Grey
RAL 7037

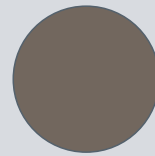

Chocolate Brown
RAL 7017

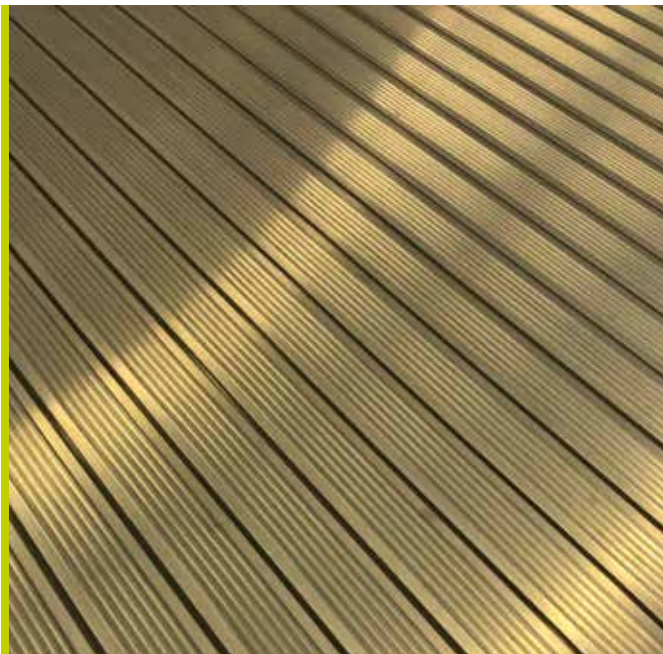

MODULAR DECKING: NEATDEK 188

Neatdek 188 has a unique overlapping surface designed to allow for discreet drainage and safe footing in all types of footwear. Ideal for raised floors and balconies, Neatdek 188 also provides total privacy by restricting views from above and below.



- | **Fire Rating:** A1 Fire Rated (mill finished) and A2 Fire Rated (colour coated)
- | **Modular Solution:** Manufactured in multiple modules to be combined on site
- | **Bespoke:** Manufactured to your exact requirements
- | **Spanning Capabilities:** Market-leading capabilities
- | **Slip Resistance:** Categorised as 'low risk of slip' in both wet and dry conditions
- | **Drainage:** Free draining
- | **Surface Contact Area:** 100%
- | **Free Air Rate:** 3%
- | **Technical Data Sheet:** Available upon request

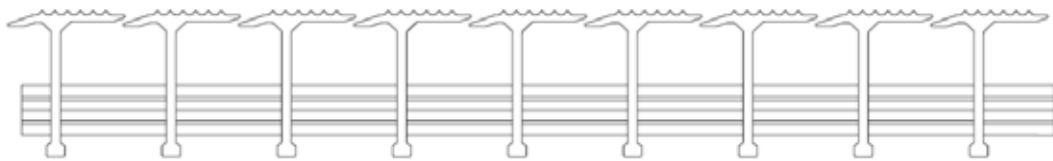

Colour Options

Our systems are available with a durable coating that features curing agents selected for their excellent hard wearing properties, UV resistance and protection against weathering. Available in a choice of standard colours, they provide a more natural and traditional aesthetic where required. Alternatively, we can coat to any required RAL colour.

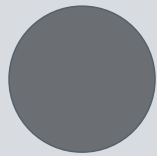

Anthracite Grey
RAL 7016

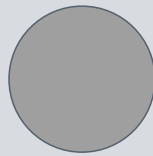

Dusty Grey
RAL 7037

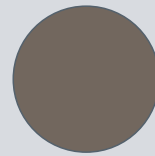

Chocolate Brown
RAL 7017





MAINTENANCE FLOORING

Flat Bar • NI Bar

Manufactured in the UK from 100% aluminium. Our two durable grille systems are ideal for maintenance flooring and heavy-duty industrial environments. Both provide a lightweight solution with excellent load-bearing capabilities due to the swage-locked construction. These solutions are extremely versatile as they are also suitable for a range of non-flooring applications, such as cladding and ventilation grilles.



SUITABLE APPLICATIONS

Industrial flooring and
stair treads

Mezzanine floors

Maintenance galleries

Roof access walkways

Ventilation grilles

Staging

Cladding

Screening

Balustrade infills

MAINTENANCE FLOORING: FLAT BAR

Our Flat Bar system provides a modular, lightweight and cost-effective option for maintenance flooring. Flat Bar is available in two bar thicknesses (3mm and 5mm) and can be used in a variety of applications.

SERRATED FLAT BAR

Flat Bar is available with a serrated surface, which provides additional slip resistance, making it ideal for hazardous conditions.

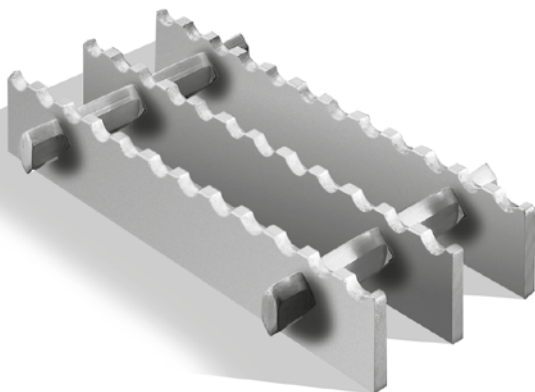

- | **Fire Rating:** A1 Fire Rated (mill finished) and A2 Fire Rated (colour coated)
- | **Modular Solution:** Manufactured in multiple modules to be combined on site
- | **Bespoke:** Manufactured to your exact requirements
- | **Spanning Capabilities:** Market-leading capabilities
- | **Drainage:** Free draining
- | **Surface Contact Area:** 10.6% (3mm bars) and 16% (5mm bars)
- | **Free Air Rate:** 84% (3mm bars) and 79% (5mm bars)
- | **Technical Data Sheet:** Available upon request

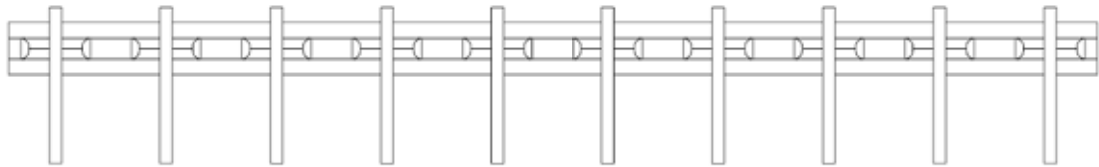
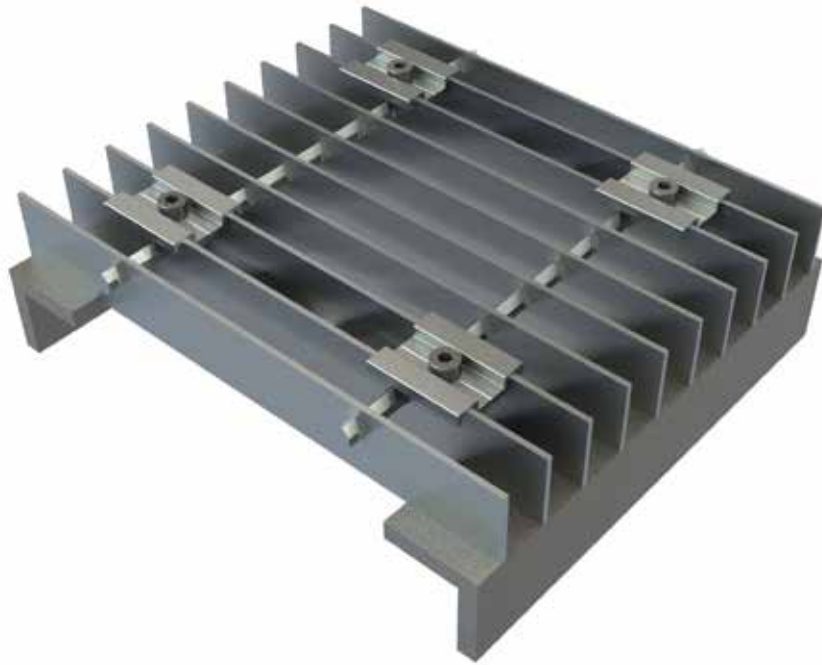

Colour Options

Our systems are available with a durable coating that features curing agents selected for their excellent hard wearing properties, UV resistance and protection against weathering. Available in a choice of standard colours, they provide a more natural and traditional aesthetic where required. Alternatively, we can coat to any required RAL colour.

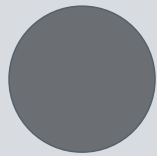

Anthracite Grey
RAL 7016

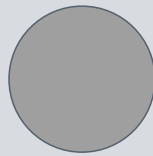

Dusty Grey
RAL 7037

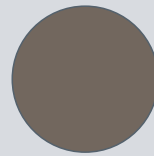

Chocolate Brown
RAL 7017



MAINTENANCE FLOORING: NI BAR

The NI Bar's ribbed surface makes it a great solution for environments where slip resistance is important. The I-shaped profile of the bars also makes the NI Bar ideal for projects that require a more high-end aesthetic without compromising the excellent spanning capabilities.

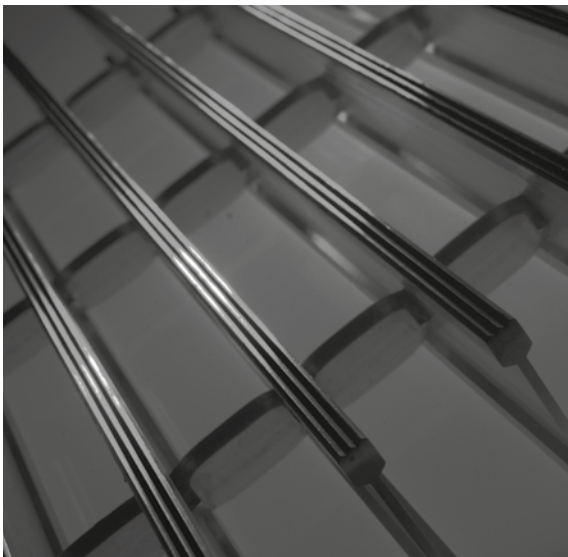

- | **Fire Rating:** A1 Fire Rated (mill finished) and A2 Fire Rated (colour coated)
- | **Modular Solution:** Manufactured in multiple modules to be combined on site
- | **Bespoke:** Manufactured to your exact requirements
- | **Spanning Capabilities:** Market-leading capabilities
- | **Drainage:** Free draining
- | **Surface Contact Area:** 21%
- | **Free Air Rate:** 75%
- | **Technical Data Sheet:** Available upon request

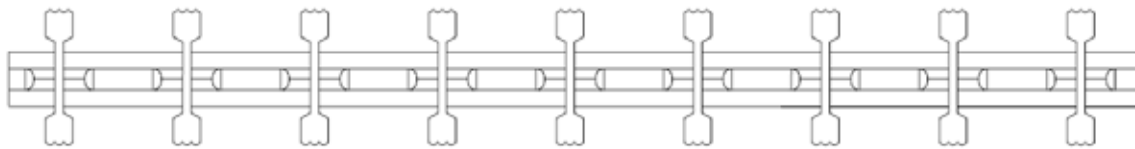

Colour Options

Our systems are available with a durable coating that features curing agents selected for their excellent hard wearing properties, UV resistance and protection against weathering. Available in a choice of standard colours, they provide a more natural and traditional aesthetic where required. Alternatively, we can coat to any required RAL colour.

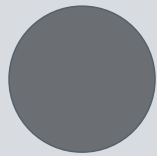

Anthracite Grey
RAL 7016

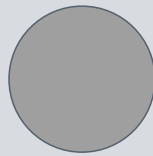

Dusty Grey
RAL 7037

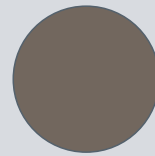

Chocolate Brown
RAL 7017

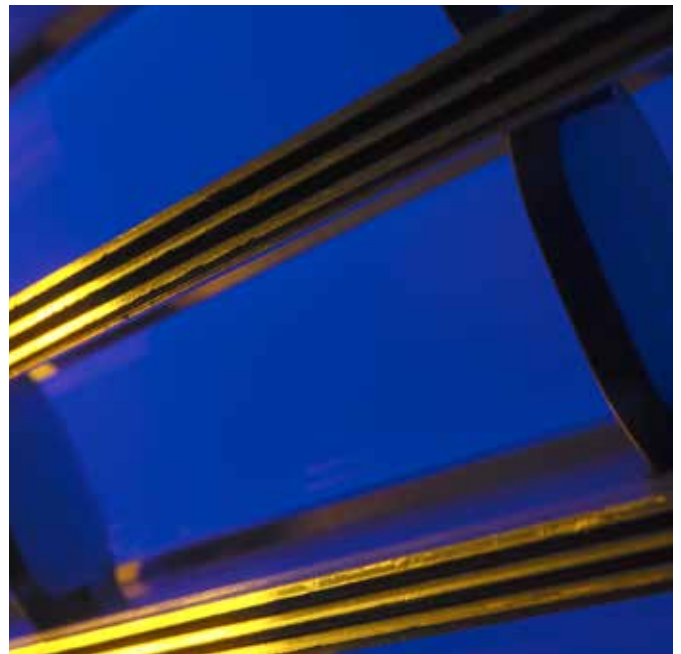
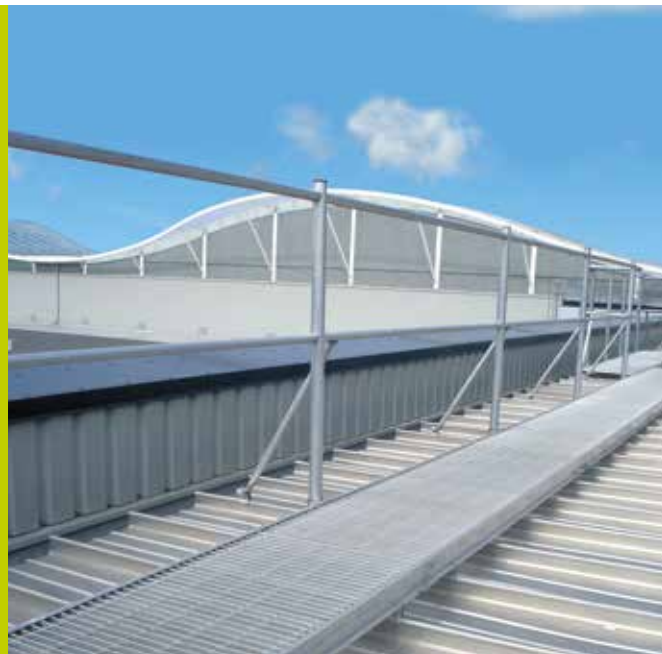



SOLAR SHADING

Louvredek • Brise Soleil

We manufacture two solar shading systems that provide excellent sunscreen performance. Our Louvredek and Brise Soleil solar shades are able to reduce a building's heat gain, serve as a useful access walkway for maintenance staff and provide a contemporary architectural design feature.



SUITABLE APPLICATIONS

Canopies for doors
and windows

Combined sunshades/
access walkways

Screening

Ventilation louvres

SOLAR SHADING: LOUVREDEK

Our Louvredek solar shading consists of panels that are angled to create shade from the sun and can either be manufactured solely as a solar shade or with extra bars to allow for additional use as a maintenance walkway.

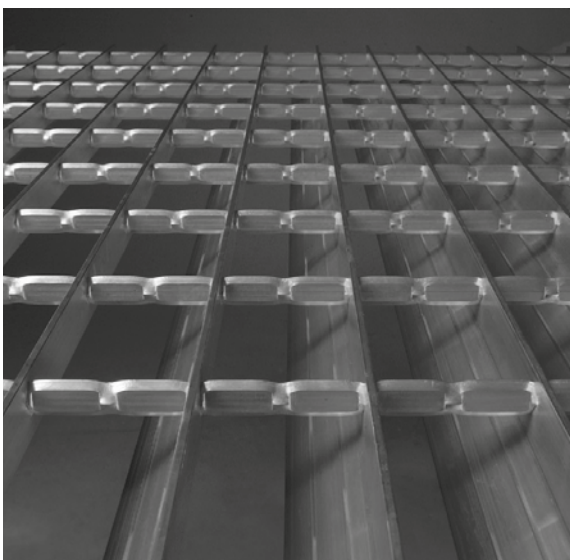

- | **Fire Rating:** A1 Fire Rated (mill finished) and A2 Fire Rated (colour coated)
- | **Modular Solution:** Manufactured in multiple modules to be combined on site
- | **Spanning Capabilities (Solar):** Typical span of 2.5m
- | **Spanning Capabilities (Solar & Walkway):** Market-leading capabilities
- | **Drainage:** Free draining
- | **Surface Contact Area (Walkway):** 16% (plain bar) and 10.6% (serrated bar)
- | **Free Air Rate:** 85% (Solar & Walkway) 88% (Solar)
- | **Technical Data Sheet:** Available upon request

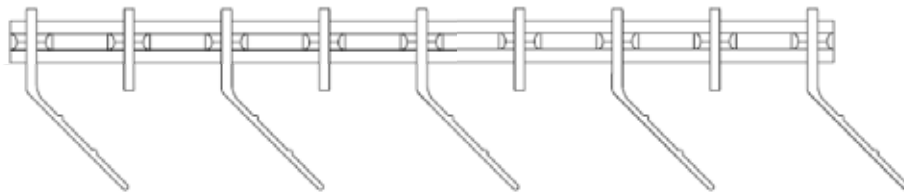

Colour Options

Our systems are available with a durable coating that features curing agents selected for their excellent hard wearing properties, UV resistance and protection against weathering. Available in a choice of standard colours, they provide a more natural and traditional aesthetic where required. Alternatively, we can coat to any required RAL colour.

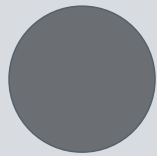

Anthracite Grey
RAL 7016

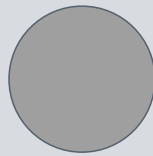

Dusty Grey
RAL 7037

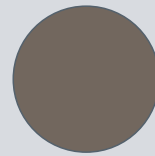

Chocolate Brown
RAL 7017



SOLAR SHADING: BRISE SOLEIL

Brise Soleil uses curved alternate louvre extrusions to provide the same high performance as Louvredek, either as a combined walkway/sunscreen or solely as a sunscreen.



- | **Fire Rating:** A1 Fire Rated (mill finished) and A2 Fire Rated (colour coated)
- | **Modular Solution:** Manufactured in multiple modules to be combined on site
- | **Spanning Capabilities (Solar):** Typical span of 3m
- | **Spanning Capabilities (Solar & Walkway):** Market-leading capabilities
- | **Drainage:** Free draining
- | **Surface Contact Area (Walkway):** 16% (plain bar) and 10.6% (serrated bar)
- | **Free Air Rate:** 85% (Solar & Walkway) 88% (Solar)
- | **Technical Data Sheet:** Available upon request

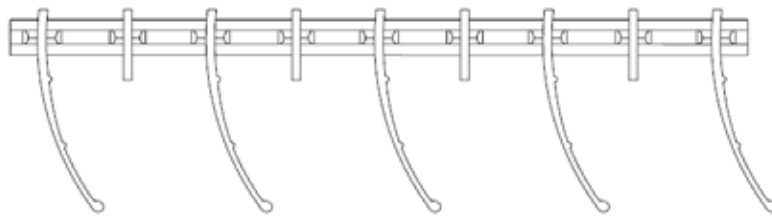

Colour Options

Our systems are available with a durable coating that features curing agents selected for their excellent hard wearing properties, UV resistance and protection against weathering. Available in a choice of standard colours, they provide a more natural and traditional aesthetic where required. Alternatively, we can coat to any required RAL colour.



Anthracite Grey
RAL 7016

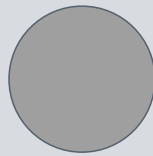

Dusty Grey
RAL 7037

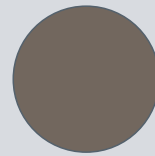

Chocolate Brown
RAL 7017



Buckingham Palace



AIRC, Cranfield University



Centre Court, Wimbledon

King Abdulaziz International Airport, Saudi Arabia



Millennium Bridge, Gateshead



The Slate, Warwick



Millennium Garden, Nottingham



Peace Bridge, Londonderry

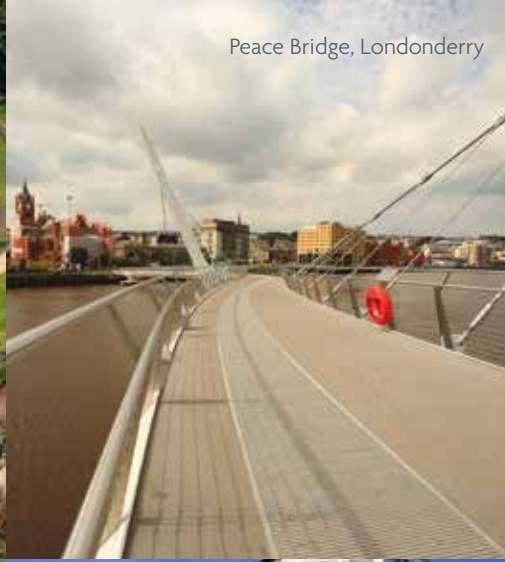

Castle View, Windsor



Heathrow Airport



Media City, Salford



Dublin Airport T2



Finnieston Substation, Glasgow



Tower of London



NV Buildings, Salford Quays

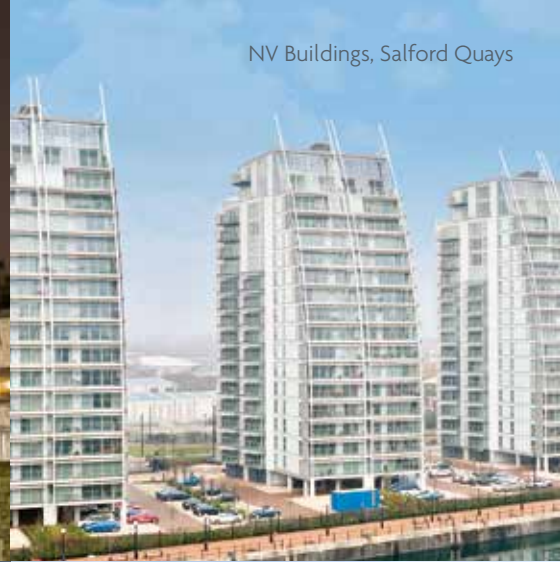

Estadio BBVA Bancomer, Mexico

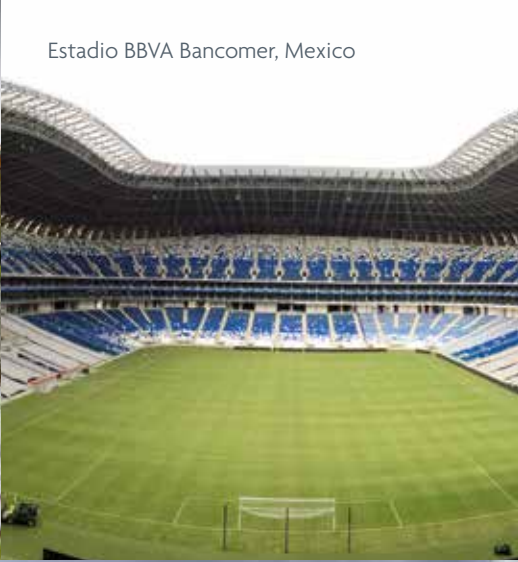

PROJECT PORTFOLIO



The Hepworth Gallery, Wakefield

Becon Les Bruyeres Bridge, Paris



St. James's Gate Guinness Brewery, Dublin

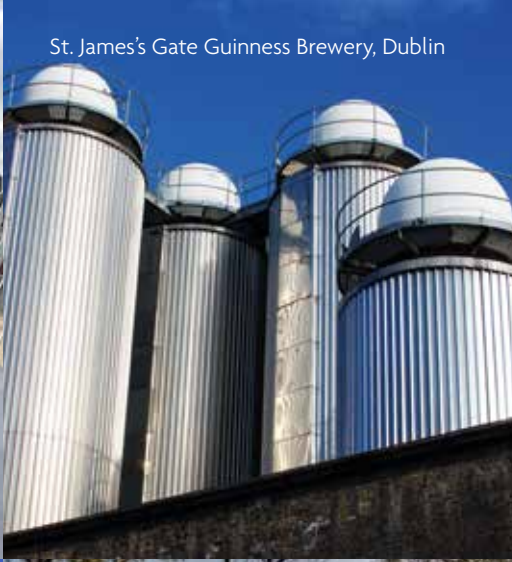

Materials Innovation Factory, Liverpool



Royal Shakespeare Company, Stratford upon Avon



Living Bridge, Limerick

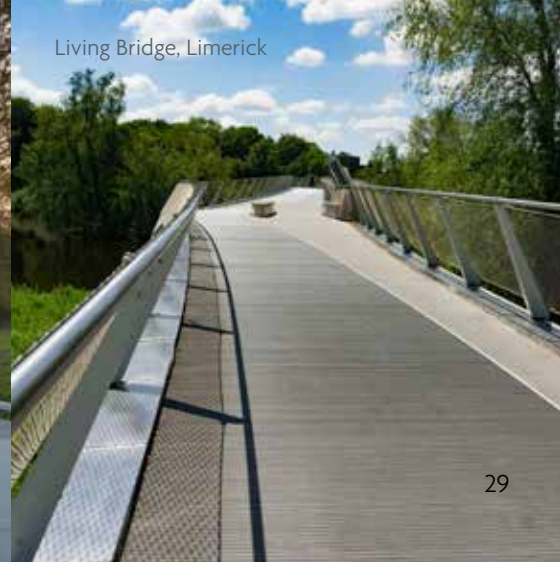

American Military Memorial, Cambridgeshire



TESTIMONIALS

GET IN TOUCH

| 01653 695 721

| sales@neaco.co.uk

| www.neaco.co.uk

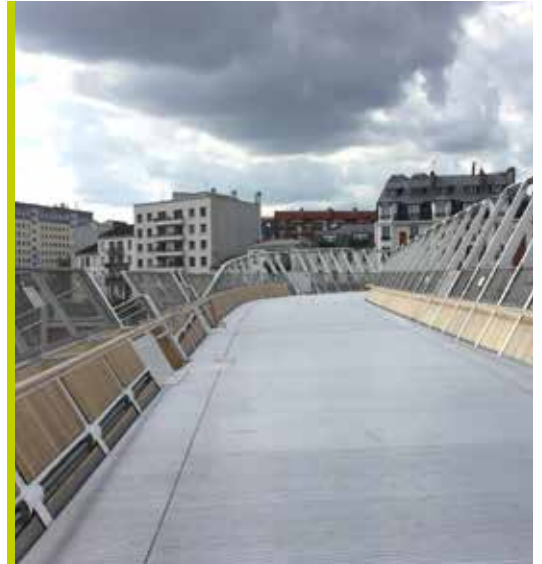

I'm more than happy with the service and products supplied by Neaco - their combination of decking and balustrade has been an excellent choice for this development. I'm familiar with the products, having used them on a number of other projects as well as my own home.

BRAMHALL BLENKHARN ARCHITECTS

The client is over the moon with the result of the redevelopment and Neaco's service was very involved from start to finish. They attended regular on-site meetings to discuss the installation details and dealt with any issues quickly and effectively.

WHARTON CONSTRUCTION

Neatdek's T-bar profile was ideal for the walkway as it gives the feel of transparency, drains water effectively and doesn't block light yet provides a large contact area with just a 5mm gap between grilles, making it safe to walk on for even the most impractical types of footwear. It also provides a contemporary industrial look which matches the overall aesthetics of the development with a ready mill finish.

XSITE ARCHITECTURE



It was important to provide a design for the Brise Soleil that complemented the external appearance of the new building and this has been achieved. We supplied the specific RAL colour reference of the window frames and Neaco were able to match the grey finish that has been used throughout the school. Initially Neaco provided a prototype and we held discussions with the main contractor, WM Birch & Sons Ltd, to agree on the appropriate size and spacing for the louvre blades. The end result is excellent, being attractive, functional and robust.

SENIOR ARCHITECT AT YORK CITY COUNCIL

We have used Neaco on a number of past projects. Neaco's products are high in quality and we like the simplicity of their design. Neaco's capabilities provide a one-stop shop for design consultation, measuring, manufacturing and fitting, so working with them removes a lot of the agony that can occur on some projects.

ALSTON MURPHY ARCHITECTS

Neaco's design, product and manufacturing service are superb. Projects like this are subject to tight build schedules to minimise disruption to the college's activities, so we needed a fast manufacturing turnaround and installation which Neaco provided in time for the start of a new academic year. Neaco provided comprehensive technical support with site survey, design and installation. They achieved efficient completion of the work on site to a high standard whilst minimising disruption to other areas of the site and other contractors involved in the project.

HOBSON & PORTER



We wanted an aesthetically pleasing façade and Neaco's product was the most visually impressive and commercially viable choice. The completed installation looks very smart and Neaco's technical support was excellent. They were very flexible in providing a design solution which accommodated the structural demands of the building and we will definitely work with Neaco again in future projects of this type.

DANE ARCHITECTURAL

We wanted a contemporary aesthetic and that's why we chose Neaco. Their balcony systems provide design versatility with modular components which combine for a made-to-measure solution. In terms of installation, it was a technically challenging project and Neaco dealt with any issues quickly and effectively. We are proposing to use Neaco again for the next refurbishment project.

CTD ARCHITECTS

Neaco's products were ideal for the demanding technical requirements of our project which included a curved roof structure - the walkway is a versatile system which has the ability to adapt to its curvature. It's also very strong, robust and looks great in comparison to plastic alternatives on the market.



EUROSAFE SOLUTIONS

Other products in the **Neaco Architectural Range**



Spectrum
BALUSTRADE



Balconies
WALK-ON AND JULIET DESIGNS



Structural Glass
BALUSTRADE



The Bathing Range
ADAPTIVE BATHROOM FACILITIES



Registered Office:

Norton Grove Industrial Estate, Norton, Malton, Yorkshire YO17 9HQ England

T 01653 695 721 **E** sales@neaco.co.uk

www.neaco.co.uk

Registered England 1065772. VAT NO. 168 2239 51.