

OVERHEAD LIFTS



Always close at hand



There are many advantages with an overhead lift. Naturally, the combination of function and safety, being able to lift a patient without the risk of injury to either the patient or the caregiver, is most important. Nearness, simplicity and versatility are other advantages.

Lifting a person demands confidence. The patient must feel assured that the lift functions the way it is supposed to and that the assisting caregiver has the right knowledge.

Thanks to the fact that Liko has focused on lifting and working close to patients, relatives and care staff for more than 30 years, we have acquired a solid base of knowledge. This longstanding experience and our expertise are our most important assets when we develop new products and methods.

Each situation is unique and requires an individual solution. Our overhead-lift experts will be pleased to help you analyze your needs and suggest appropriate installation alternatives.





Better quality of life

-The overhead lift saves our backs and makes each day better for the residents."



“We like our overhead lifts for many reasons. First and foremost, of course, is the **CAPACITY** to lift patients. When you have access to a lift, you are soon spoiled, which you really notice when you are in a room without one.

In my experience, an overhead lift is always close at hand where it is needed and, therefore, it is used frequently. We use our overhead lifts many times every day all year round, so it is important that they are **EASILY ACCESSIBLE** and easy to use. Then, lifting becomes a regular procedure, and that’s just the way we want it to be. The overhead lift is a safe and secure assistive device that makes life easier for both the patient and for those of us who work in care.

We have seen countless back injuries caused by attempts to lift patients manually, something which is **COSTLY** for everyone concerned – injured personnel as well as the employer. Our overhead lifts save our backs and give our residents a better day.”

Paula Nyberg, Physiotherapist,
Bergsunds Nursing Home, Stockholm

Being lifted is a highlight of the day for many residents at Bergsunds Nursing Home.



A stroke patient places full trust in Marianne and Liko's overhead lift. The lift is also used in rehabilitation.

-Safety is the first thing that comes to mind when Liko is mentioned."

"I would have to say that the overhead lift is safe and secure and gives us and the patients greater **MOBILITY**. For most people, being lifted isn't something that feels natural. Especially someone who has suffered a stroke or been injured in a car accident. Therefore, it is a good idea not to make too much of a fuss, since the patient's **INTEGRITY** is at issue.

Liko's lifts are **UNOBTRUSIVE** and take minimal space in the room, something which is more important than you might think. At the same time, the lift must feel one hundred percent safe. The patient literally places his or

her life in the caregivers' hands, which requires quite a lot of confidence. **SAFETY** is the first thing that comes to mind when Liko is mentioned. Always safety first.

Another thing that makes Liko unique is the enormous **RANGE** of installation alternatives, lift units, slings, slingbars and other lifting accessories. This means we can adapt each individual lift in the best possible way."

Marianne Selberg, Head Nurse, Sunderby Hospital, Luleå

A complete system

An overhead lift is much more than simply a lift unit. Even though the lift unit does much of the work, it has plenty of help. By an overhead lift, we mean a whole system of components which together make it possible to lift a patient. It is an easy-to-use system that is always close at hand.

Installing an overhead lift system requires careful consideration. You must know the types of problems that will need to be solved, the lifting situation and how you intend to lift with the system. To facilitate installation, it is also essential to know the underlying technical conditions and prerequisites in the location where the system is to be installed. To create the optimal system, the following should be considered: > **What do we wish to achieve?** > **Will we be lifting to one or several locations?** > **How much space will be needed for lifting?** > **How will the room be furnished?** > **How will installation be performed?**

We at Liko will be pleased to help with your analysis. In this way, you can be assured of getting the optimal system to meet your specific needs. Liko has solutions for all types of settings and lifting, complete systems that give patients and caregivers freedom.

A FIXED RAIL is ideal for lifting between two fixed points

Lifting between a bed and a wheelchair is one example. The rail can be straight or with curves and is often installed with unobtrusive upright supports that are affixed to the wall. A curved rail, however, always requires ceiling fixtures. The straight rail is a simple, effective and economical alternative.

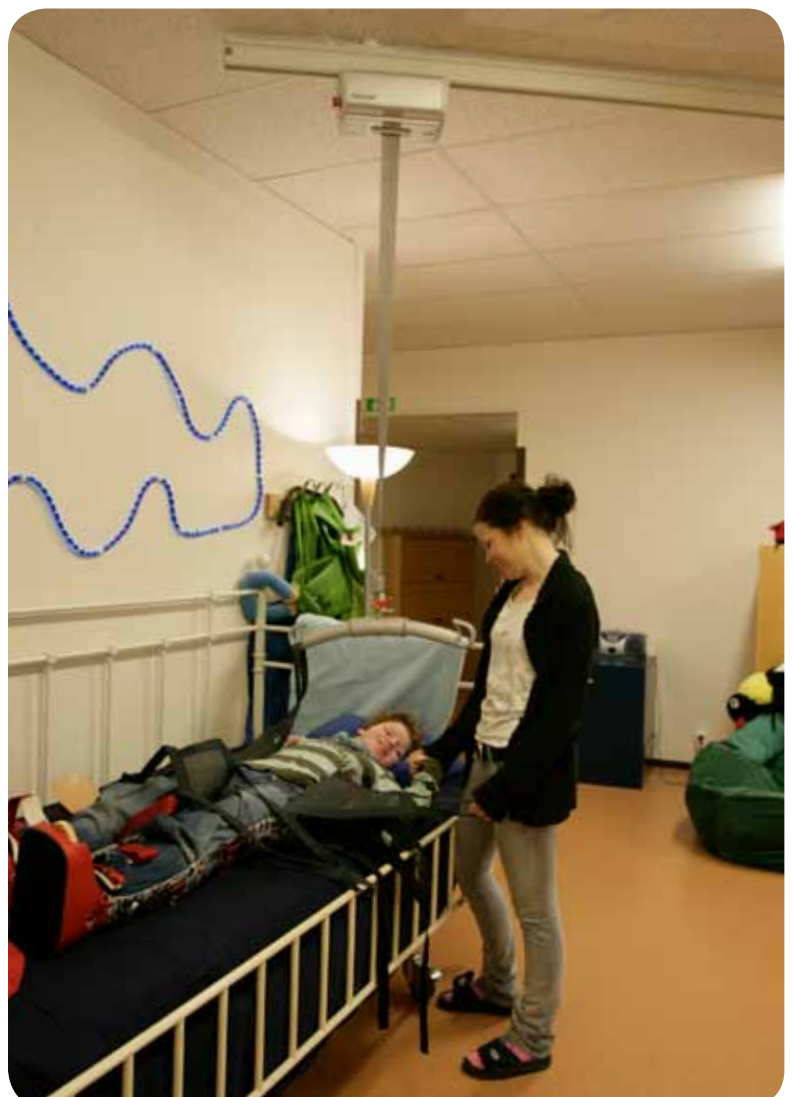
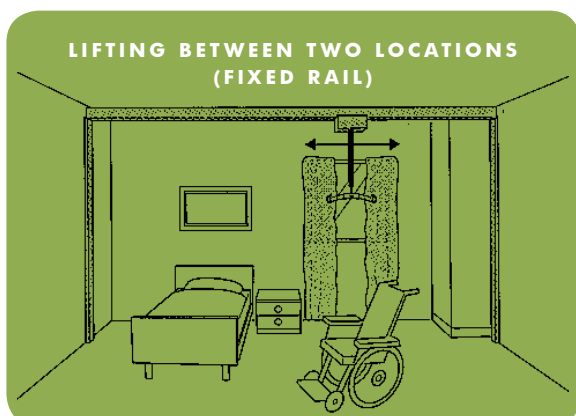



The TRAVERSE SYSTEM gives you the freedom to lift in many locations.

A traverse system consists of a movable rail mounted on two fixed rails and is often the best functional solution, since it allows greater freedom to move and lift over a greater area.

Traverse rails can be connected with switches to enable, for example, transfers between different rooms. Another important advantage is that a traverse system adjusts itself automatically to the patient's centre of gravity during lifting.

The traverse system is the most common type of rail system and the most widely appreciated among care personnel.

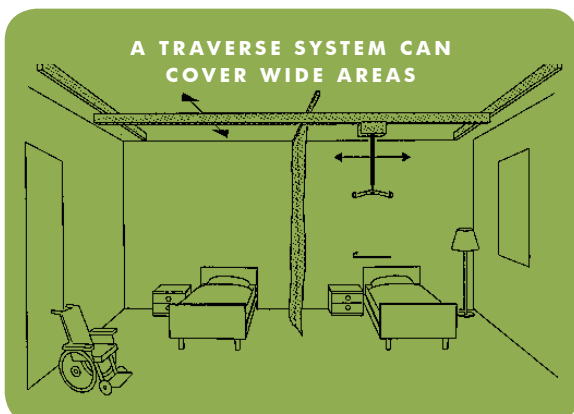
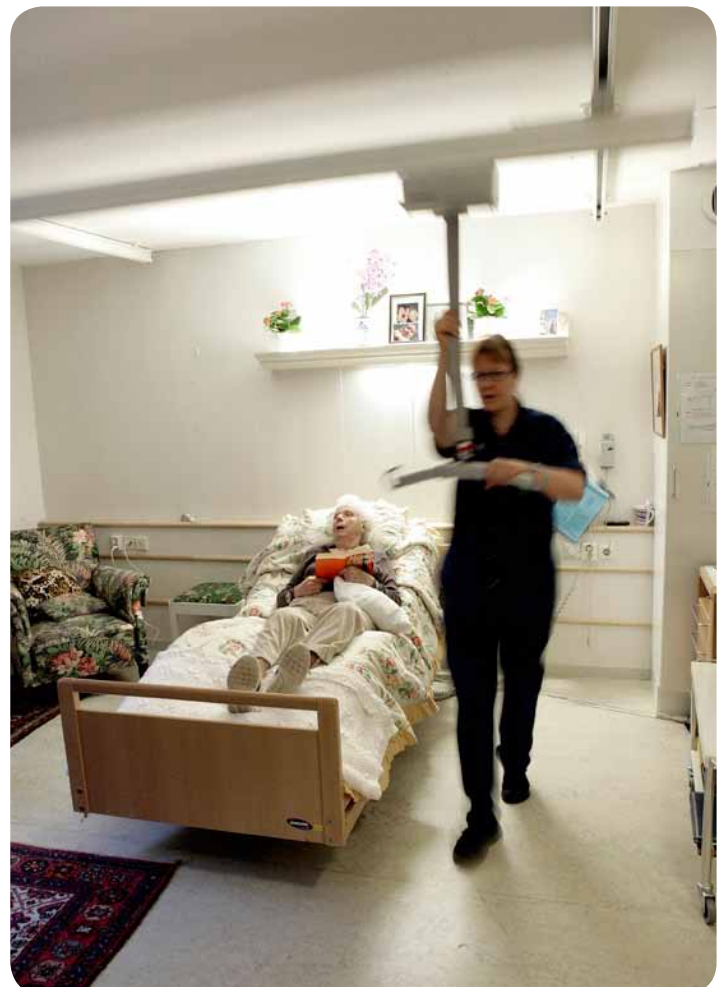



Likorall R2R makes it possible to transfer a patient between two rooms that are not directly joined by a rail.

Transfers from ROOM TO ROOM on the rail system

Liko has always been at the forefront when it comes to room-to-room solutions. Here, several factors must be considered. Naturally, safety is the first concern, but other things, such as the aesthetics of the room, are also important. Liko's installation alternatives make lifting convenient without the need for altering doorways and other features.

With Liko R2R, two lift units are connected at the doorway to enable safe, trouble-free transfer of the patient between rooms. Multirall allows you to perform the same type of transfer using only one lift unit and a room-to-room strap.



With Multirall, room-to-room transfers can be performed using only one lift unit.

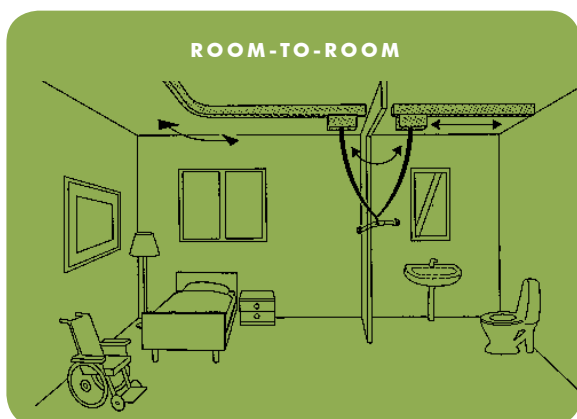



FreeSpan Straight Rail is a freestanding system that is easy to assemble and disassemble or move between rooms as needs change. No tools are required.



FreeSpan Traverse can cover a large area in a room. No structural requirements for the room's walls or ceiling.

Make the overhead lift mobile with a **FREESTANDING SYSTEM**

A freestanding system can be a good alternative to a ceiling-mounted overhead lift. In some cases, a freestanding system is ideal if you want to try using an overhead lift but do not wish to install permanent fixtures in the walls and ceiling. In other cases, the need for lifting may only be temporary, or you may wish to avoid a permanent installation for other reasons. With a freestanding system, there are no special structural strength requirements for the walls or the ceiling.

Liko has several versions of freestanding systems which offer virtually the same versatility as a permanent installation, even when it comes to very heavy lifting. Thanks to its wheels, when assembled, FreeSpan Straight Rail can be easily moved between different rooms.



FreeStand is a sturdy and economical system for lifting on a straight rail.



Even extremely heavy patients can be lifted comfortably and safely with Liko's Ultra lift system

Lifting very HEAVY PATIENTS is easy with the Ultra lift system

Lifting heavy patients requires specially designed equipment and special techniques. Liko has longstanding experience and a good understanding of the various problems that can arise in connection with heavy lifting.

For many years, we have worked closely with several large hospitals in North America that specialize in bariatric care and treatment. This has made us a pioneer in assistive devices that are specially adapted for very heavy patients.

Our Ultra lift system is rated for lifting up to 500 kg. The series includes the UltraTwin, which consists of twin lift units that work together, special slings, stretcher lifts and many other accessories.



The UltraTwin system consists of a pair of lift units that work in tandem. Here, the lift units are mounted on the UltraTwist accessory, which makes it possible to rotate the patient 360 degrees.



One rail system that makes all solutions possible

We have been developing overhead lift systems for more than 30 years and we now offer the most complete range of ceiling rails and fixtures on the market. The rails are available in a range of profile heights to meet requirements in many different settings.

In all cases, they are made of aluminium, which is very light but very strong.

The visual impact that an overhead lift system has on a room can be minimized, thanks to the fact that rails and fixtures come in different colours, and the entire rail can even be concealed in the ceiling.

Below are several examples of solutions using Liko's rail systems.



Curtain systems

Liko has developed several types of unique curtain systems that work in combination with overhead lift systems and help to create a feeling of privacy in multi-patient rooms.



Rail switches

Make it easy to switch between different rail systems. Choose between manual or electric switch control.



Raised traverse rail carrier

The traverse rail requires minimal space. Also available in a lowered version to allow clearance for lighting fixtures and sprinklers, etc.



Turntable switch

With a turntable switch, the overhead lift unit can change rails in different directions.



Traverse switch

Makes it possible to run from a fixed rail to a traverse system, e.g. between different rooms.



Portability

Different solutions make it possible to move the lift unit between different rooms as lifting needs change.

The Sling is Half the Lift.

1. Horizontal lifting

It is often severely injured people who need to be lifted in a horizontal position. We have several different stretchers and several methods for, for instance, intensive care, surgery, back-injured and burnt patients. We also have accessories for transfers from emergency and ambulance gurneys.

2. Repositioning

Lifting and repositioning patients is one of the most common operations around the bed. It is also the operation which causes many work-related injuries. We offer several different aids to facilitate this task.

3. Bed to Chair

The most common lifting need for most patients. Comfort, safety and security are important needs to consider. For best result, the sling bar should also be selected carefully.

4. To/From the Toilet

Lifting severely disabled people to and from the toilet and simultaneously being able to take off their clothes requires thought-through slings which provide maximum access around the body without compromising safety.

5. Pain/Pressure Sensitive

Pain-sensitive people have to be lifted with outmost care. Soft-padded slings and multipoint suspension contribute to the distribution of pressure.

6. Standing/Gait Training

Being able to stand up and put weight on skeleton and muscles is not only promoting health on a physical plane but also gives satisfaction and increased confidence. Liko's lifting accessories for standing provide new and exiting possibilities to stand and move under safe and controlled forms.

7. To/From the Floor

It is not just when somebody has fallen down that you need to lift from the floor. In rehabilitation the lifting need to and from the floor is great. With Liko's lifts, in combination with a sling supporting the entire body, this transfer is made in the gentlest possible way for the patient as well as the caregiver.

The sling's being half the lift is a concept we have advocated for many years. Without a well-adapted sling, lifting is never as gentle and smooth as it should be. This is the very basis of Liko's philosophy when we develop our slings.

For almost thirty years we have studied lifting situations and know that, in order to be able to develop an optimal sling, you have to know the details about a patient's function and situation on all planes, both physically and socially. Our knowledge in this field has led to Liko's having the market's most functional, safe and complete range of slings today. Liko has slings for every situation.

1 HORIZONTAL LIFTING



2 REPOSITIONING



3 BED TO CHAIR



4 TO/FROM THE TOILET



5 PAIN/PRESSURE SENSITIVE



6 STANDING/GAIT TRAINING



7 TO/FROM FLOOR



8 LIFT AND HOLD



8. Lift and Hold

Even lifting and holding an arm or a leg can be a heavy task which becomes easier if a patient lift is used. We offer specially developed lifting accessories for this particular task.

9. Bath and Shower

Liko's slings for bath and shower are made from permeable plastic-coated net. They are available in several models to meet different patients' individual needs for support and comfort in the best possible manner.

9 BATH AND SHOWER



10 LEG AMPUTEES



11 LIFTING CHILDREN



10. Leg Amputees

Liko has several methods for lifting leg-amputees. The model selected depends on the degree of the amputation and on the lifting situation.

11. Lifting Children

Children are not small adults. The lifting needs in rehabilitation are often very special and require great care and special skills. We at Liko have long experience in this area and are always developing new methods.

12 DISPOSABLE SLING



13 TO/FROM THE POOL



14 BARIATRIC PATIENTS



12. Disposable Sling

Not using the same sling for many different patients is a step in the fight against multi-resistant bacteria. Therefore Liko has developed the disposable sling Solo.

13. To/From the Pool

Lifting people into a pool can be done while they are either sitting on a bath chair or in a suitable sling made from permeable plastic-coated net.

14. Bariatric Patients

Lifting extremely heavy patients requires both specially designed lifting equipment and special technique. We have products for lifting and repositioning patients weighing up to 500 kg (1,100 lbs.).

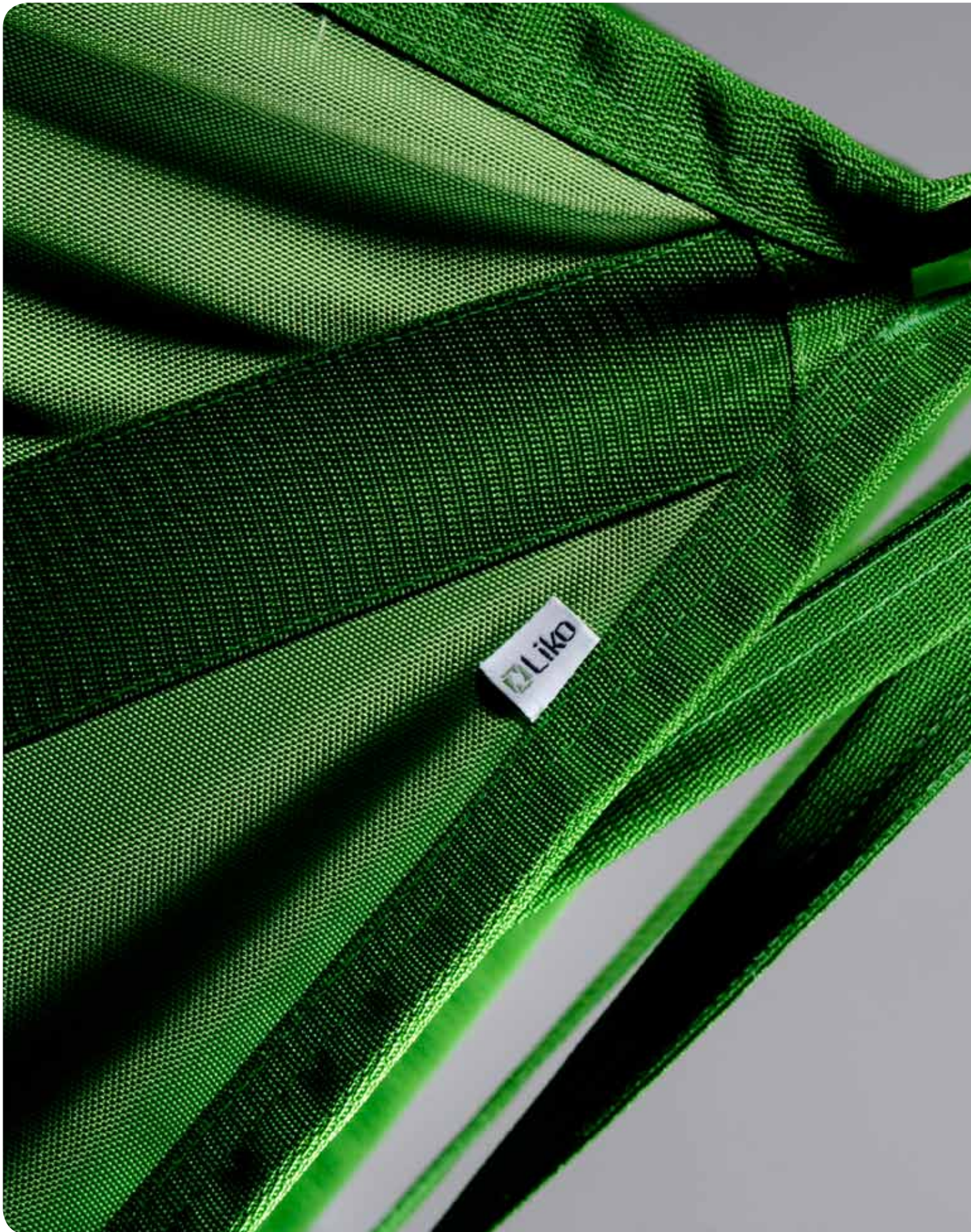



Safety first – always

Liko's approach to safety continues to set an industry standard. We have been developing our products for more than thirty years, and safety has always been our prime concern. Our products are always tested by accredited testing institutes; but for us, that simply isn't enough.

Our own risk analyses are considerably more extensive and thorough. It might be said that our own knowledge and experience are the basis for the most difficult product-approval tests.

Since we know just about everything there is to know about lifts and lifting, all of this knowledge and experience is naturally implicit in our analyses when we develop our products.

When you use Liko's products you can always be assured that you are in safe hands.



Our fasteners and fixture components always have a fourfold safety factor, and our lift straps are designed to withstand ten times the maximum load for which they are approved.

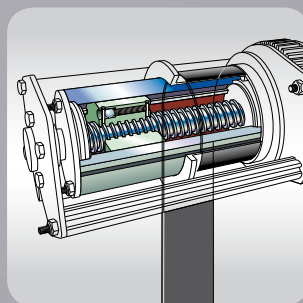

Likorall is equipped with a patented safety drum, with lowering-speed control, to ensure that the patient is always lowered in a controlled manner.



Liko has been the first to introduce many innovative safety features. The slingbar safety latch is one example.

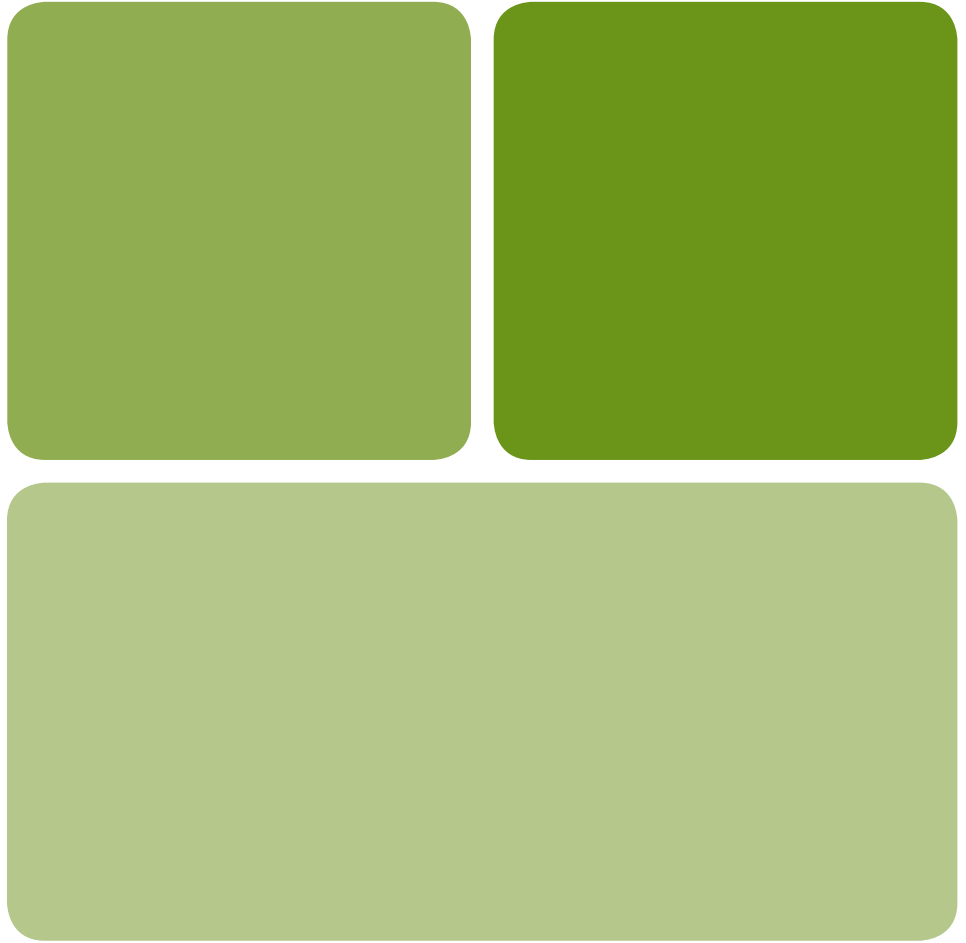

Liko has the complete solution for safe lifting and transfers

Now you have read about products that are essential for dealing with most lifting and transfer situations that arise in your care setting. But that isn't quite enough. Over the years, we have discovered that a good, safe solution stands on three legs.

First, you need safe, easy-to-use products. Secondly, you need to know how to handle your assistive devices safely and perform safe lifts and transfers. And finally, you need working methods that ensure that personnel really are working in the right way – a programme for safe lifting.

Our knowledge gives you the expertise for all three. With Liko's help, you can guarantee that personnel and patients have a safe lifting environment.

www.liko.com

Manufactured by:
Liko AB
Nedre vägen 100
975 92 Luleå
Sweden
info@liko.se

Local representative in UK
Hill-Rom Limited
Clinitron House, Ashby Park
Ashby de la Zouch,
Leicester LE65 1JG
Tel: 01530 411000
Fax: 01530 411555
info@liko.co.uk

To find your local Liko representative,
please visit www.liko.com or call
+46 (0)920 47 47 00



A **Hill-Rom** Company