

Mumford & Wood Limited is the UK's leading provider of quality timber fenestration.

Copyright © 2014 Mumford & Wood Limited.

All rights reserved.

Except as allowed by law, no part of this publication may be reproduced in any form without written permission of Mumford & Wood Limited. As a result of progressive development, we reserve the right to modify or change specifications and descriptions without prior notice.

The Mumford & Wood logo is a registered Trademark of The Performance Timber Products Group.

Uniclass L41312:P5	EPIC D1316:X5
CV/SB (31.45)	xi

ESSENTIAL GUIDES



MUMFORD  
& WOOD

EST. 1954



## SITE INSTRUCTION, AFTERCARE MANUAL & WARRANTY

Mumford & Wood Ltd  
Tower Business Park, Kelvedon Road,  
Tiptree, Essex CO5 0LX

Tel: 01621 818155  
Fax: 01621 818175  
Email: [sales@mumfordwood.com](mailto:sales@mumfordwood.com)  
[www.mumfordwood.com](http://www.mumfordwood.com)



British craftsmanship



British craftsmanship

[www.mumfordwood.com](http://www.mumfordwood.com)

THE FINEST TIMBER WINDOWS & DOORS

THE FINEST TIMBER WINDOWS & DOORS



*British craftsmanship*

*Congratulations, you have taken delivery of your Mumford & Wood order. Your windows and doors have been manufactured to exacting standards in closely controlled factory conditions and will provide great customer satisfaction over many years if installed and maintained correctly.*

*It is essential that the instructions contained in this manual are followed carefully as failure to do so may invalidate our market-leading warranties in the unlikely event of a claim.*

*This is an important document. Following installation, this manual should be passed to the home owner or building premises owner in order that maintenance and aftercare is fully undertaken. Failure to do so could affect the Mumford & Wood Warranty and Terms & Conditions.*

*Our advice and recommendations can be found in this manual.*



**MUMFORD  
& WOOD**

EST. 1954

## CONTENTS

3	INTRODUCTION
4	PRODUCT CARE
	CONSERVATION™ SASH WINDOWS
6	SPRING BALANCE CORDS & WEIGHTS
8	BALANCE MECHANISM
10	BALANCE MAINTENANCE
	CONSERVATION™ CASEMENTS & DOORSETS
12	INSTALLATION
14	SIDE SWING REMOVAL & INSTALLATION
15	DOOR FITTING & ADJUSTMENT
	BI-FOLDING DOORS
16	INSTALLATION & OPERATION
18	BI-FOLDING DOOR ADJUSTMENT
20	MAINTENANCE, CARE & PROTECTION OF YOUR PRODUCTS
22	MUMFORD & WOOD WARRANTY

# PRODUCT CARE

## HANDLING AND STORAGE

The customer is responsible for supplying the necessary labour or mechanical handling to unload and store the goods in a safe and correct manner without risk of injury or damage. Delivery documentation and labels will state product weights to assist in determining the correct procedures.

Our obligation is limited to delivery at a point on a safe hard road surface nearest to the delivery address.



## CHECK THE DELIVERY

On receipt of the units please ensure products are in good condition and match your order exactly. If you find faults or defects please contact Mumford & Wood immediately.

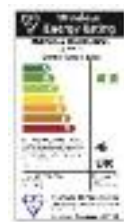

CE Marking declaration of performance for each of our products can be found on our website.



## STORAGE

- Provide a clean, dry area for storage where goods will not become damaged.
- Stack windows and door sets vertically on bearers, supported to ensure safety and stability.



- Separate products sufficiently to allow air circulation and avoid damage to or from projecting ironmongery or fittings. If goods are to be stored for a period exceeding two months the individual product wrapping should be removed for ventilation. Cover products to protect from dust and dirt.
- Our packaging is for protection of our products during transportation and must be removed prior to installation.
- **Do not** store in areas recently plastered or not adequately dried out. Keep clear of moisture and dirt or where construction processes are being carried out.
- **Do not** expose to strong sunlight, excessive heat, or store in complete darkness for long periods as the latter can discolour the finished coating.
- **Do not** lay products flat as the surface coatings and glazing systems are designed for vertical and drained surfaces.

# PRODUCT CARE

## VENTILATION OF BUILDING

Mumford & Wood's products are manufactured in closely controlled environmental conditions to maintain the correct moisture content of the wood. When carrying out wet trades where windows and doors have been fitted, it is essential to ventilate and dehumidify the rooms. The product surface coatings are not designed to protect the base material against moisture penetration in saturated enclosed atmospheres. This type of environment can cause the surface coating to blister and result in potential movement to the timber substrate which is not covered by the Company's Warranty.

Ventilation is also necessary to prevent condensation forming on the inside of the glass surface. Further airing may be required until the building is fully dried out which can often take up to six months following completion of the building.

## PROTECTION OF INSTALLED WINDOWS

Windows and doors must be protected at all times from continuing construction processes which may produce dust and other pollutants that will affect the product's finish and glazing tapes, as well as interfere with hardware operation.

Particular attention is required for construction operations

that produce abrasive grit, such as angle grinding or rendering, which will pit or scratch glass, paint surfaces and hardware finishes. Please treat your window products as you would items of furniture.

## CLEANING

Glass labels should be removed as soon as possible after installation. Whilst these are low tack, long exposure to sunlight can increase the glue bond making removal more difficult at a later date. Soften any labels on the panes of glass with water to remove more easily. Glue residue on the pane may be removed with a solvent cleaner. Please follow product use guidelines.

Use the minimum amount of water with a very small amount of mild detergent, for example washing up liquid or pure soap flakes, when cleaning the units for the first time following installation. Give a final wipe with a damp cloth or leather to remove all water from the surface.

Never hose down or use large quantities of water for cleaning as this is an unnatural application and will create moisture imbalance within the products. Subsequent movement as a result of same will not be covered by the Company's Warranty.



# CONSERVATION™ SASH WINDOWS

## SPRING BALANCE & CORDS & WEIGHTS

### INSTALLATION

- Install into prepared structural openings at least 10mm larger (5mm all round) than overall frame size. If necessary let straps in to maintain tolerance.
- Wedge evenly on all sides and under jambs and mullions; adjust to ensure frame is plumb, square and level.
- Provide additional fixing to head and cill on units over 1000mm wide.
- Check that diagonal frame dimensions are the same and the product functions correctly.
- It is best practice to use a DPM between the structure and the window section.
- **Do not** build in products.
- **Do not** use the window or door opening for access during the construction process without adequate protection.
- **Do not** use as a resting point for scaffold.
- **Do not** use excessive amounts of foam as this may deflect jambs.

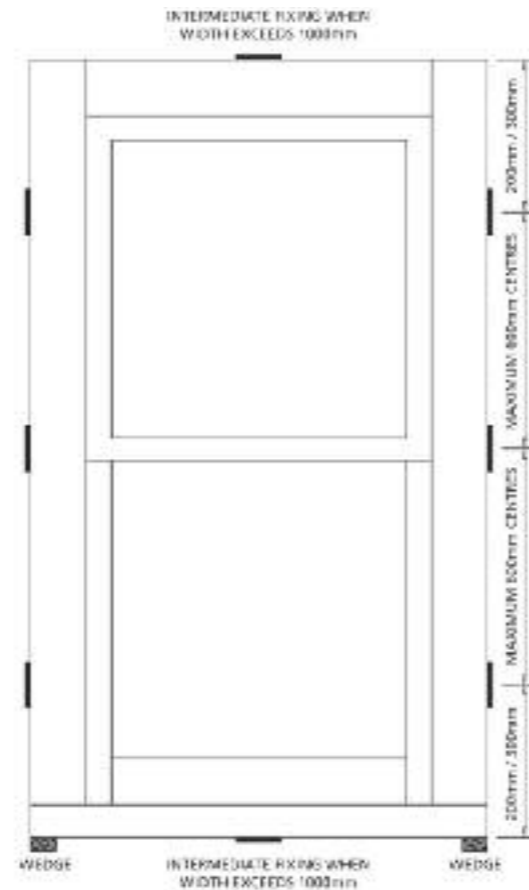

### RECOMMENDED FIXINGS & FIXING POINTS

- Recommended fixings are galvanised or stainless steel straps fixed to the external edge of the frame and the inside structure.
- Fix jambs 200mm to 300mm from each corner and at maximum 600mm centres.
- Provide intermediate fixings to head and cill when over 1000mm wide.
- **Do not** deflect jambs; screwing should be at wedge packing points. If strap fixing with packers used behind the straps, fixing must be through the packer to avoid 'see-saw' action which will bow the frame.
- **Do not** over-tighten fixing points as this will deflect jambs.

### BOX FRAME

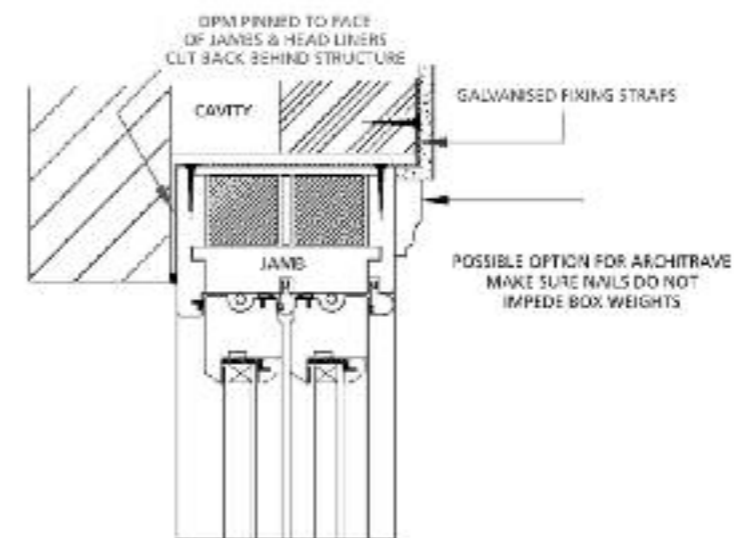

### SPRING FRAME

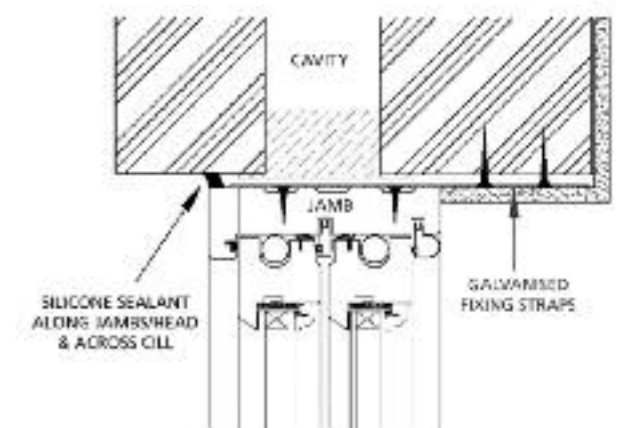

### BOX SASH WINDOWS

When installing sash windows with cords and weights **do not** enter box void with fixings or nails as sliding weights will not function.

### SEALANT JOINTS

The external joint between frame and structure should be lightly caulked with polyurethane foam and pointed with a high quality low modular sealant to colour match the adjoining masonry in accordance with the manufacturer's instructions.

# CONSERVATION™ SPRING SASH WINDOW

## BALANCE MECHANISM

### DELIVERIES WITH SASHES FACTORY FITTED:

Conservation™ sash windows with spring balances are fitted with powerful pre-tensioned torque-free balances for which no adjustment is required.

### DELIVERIES WITH SASHES SEPARATE (LARGE HEAVY WINDOWS):

For convenience in handling and fixing, larger units are delivered with sashes separate to frames for site insertion of sashes after frame fixing.

### INSTALLING SASHES

#### a) Spring sash

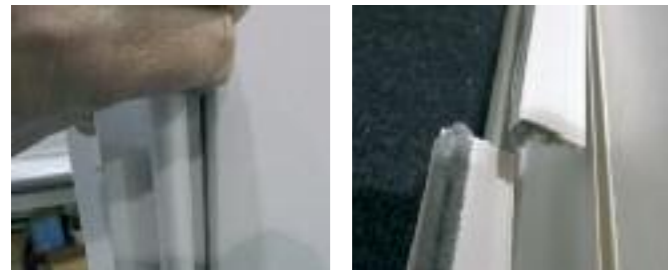

**1** Remove right hand side of staff bead, this should be left partly unclipped, then remove right hand side of parting bead.



**2** Then remove both right hand springs.



**3** Select the appropriate sash for the frame you are working on, using ID number as detailed on the label affixed to the glass.



**4** Measure the height of the sash from the top to bottom rail, work out the distance from bottom rail to cill, then cut a wooden brace and pad the brace at either end so as not to damage the sash or frame.



**5** Offer the top sash up to the frame, slotting the left hand spring groove on the sash over the left hand spring. Then place the right hand spring in the spring groove on the sash. Then replace the sash into the frame.



**6** When fitting the sash you will notice that the flipper weather seal is inverted and catches on the plastic channel on the frame. To help ease the sash into position you will need a 1mm thick gauge of plastic laminate, or similar material, to slide between sash and frame.

### INSTALLING SASHES

#### a) Spring sash continued



**7** Using the brace cut earlier push sash to upper position and place under sash.



**8** Using a hook, pull spring down and attach to the spring bracket.



**9** Replace parting bead.

**10** Cut down the brace used for the top sash and repeat the operation of measuring gaps to get the brace to the correct size.

**11** Offer bottom sash up to frame as in item 5. Follow same instructions in item 6.

**12** Using the brace, push bottom sash up to stops and insert the brace. Follow item 8. This can be a little more difficult to hook onto the spring. You may need to bend the hook out to make it longer.



**13** Then replace staff bead tapping home with a plastic mallet. Do not use rubber as you will mark the surface coating.

### INSTALLING SASHES

#### b) Cords & weights sash

**1** Remove staff bead and parting bead as for spring sash windows.

**2** Select the top sash for the frame being worked on.



**3** Loosen off screws on the side of the sash but do not remove.

**4** Pull down the sash cord on the left hand side of the frame and hook it on to the screw on the left hand side of the sash; you may need two people for this. Tighten screw.



**5** Then position the sash between the parting bead and the external frame liner but leave the right hand side so that you can see the screw. Pull down the sash cord and hook it onto the screw and tighten. Using a 1mm gauge of plastic laminate, or similar material, as in item 6 (installing spring balance sashes) and slide the sash into place.

# CONSERVATION™ SASH WINDOWS

## BALANCE MAINTENANCE

### BALANCE REPLACEMENT

In the unlikely event of failure, or possible damage, replacements can be ordered by quoting the information from the production identification label fitted on the hidden sash profile and stating either upper or lower sash. Alternatively, quote all the information printed on the bottom of the balance sleeve (the balance may have to be removed).

The sash balance units are lubricated during the production process and are designed to be self-lubricating during the operation of the window sashes. Therefore, the balances should only require a minimum of maintenance but we would recommend the following check is made annually:

- Check that the balance fixing screw is secure (do not over-tighten).
- Check that the bottom fixing bracket is secured to the sash and not damaged or distorted in any way.
- Is the balance tube damaged?
- If dirt and debris has built up at the bottom end of the balance it can be cleaned with a cloth and re-greased.
- Check that the travel stops are in place, and that the sash moves to contact the stops without any undue force. This will ensure the balances are not being over extended or crushed. Finally, check for smooth running of the sashes. Note: balances are non-adjustable.

### DECORATION

- **Do not** decorate balance tubes.
- If in any doubt, please contact us for advice and guidance as site damaged balances are chargeable replacements.

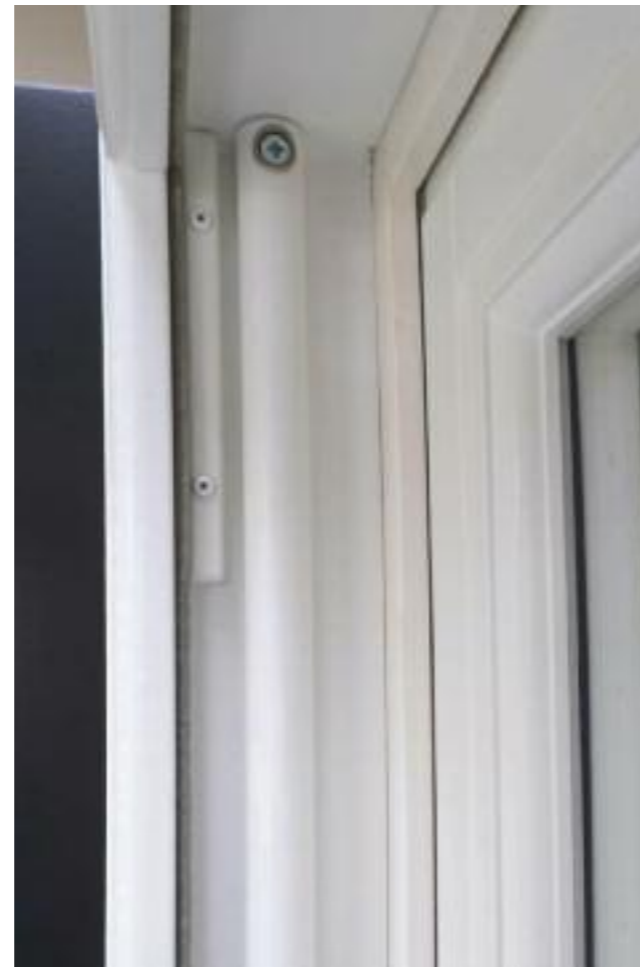

# CONSERVATION™ CASEMENTS & DOORSETS

## INSTALLATION

- Windows and door frames should be fixed into preformed openings at least 10mm larger than overall frame size (5mm all round). If necessary let straps in to maintain tolerance.
- Each frame should be wedged evenly on all sides and adjusted to ensure the frame is plumb, square and level.
- Recommended fixings are galvanised or stainless steel straps fixed to the external edge of the frame and the inside structure.
- If screwing and plugging direct to the structure through the frame great care must be taken to avoid damage to ironmongery and weatherseal.
- Doorsets should be screwed and plugged direct to the structure at hinge points.
- Deflection of frame will affect the operation of casements and doorsets, therefore screwing should be at packing points only and not over-tightened so as to alter the 4mm sash to frame clearance.

## WINDOW JAMBS

- Position at 200 to 300mm from each corner and at maximum 600mm centres.
- Fix jambs in points as close as possible to the hinges, without damaging ironmongery, with additional fixings to door frames over 2200mm high. All frames over 1000mm wide should have additional intermediate fixings to head and cill.
- Packers should be placed at mullion and transom points. Any trimmed timbers must have end grain preserved and primed without delay to provide seal against moisture ingress.
- **Do not** use the window or door opening for access during construction process without adequate protection.
- **Do not** use as a resting point for scaffold.
- **Do not** use excessive amounts of foam as this may deflect jambs.

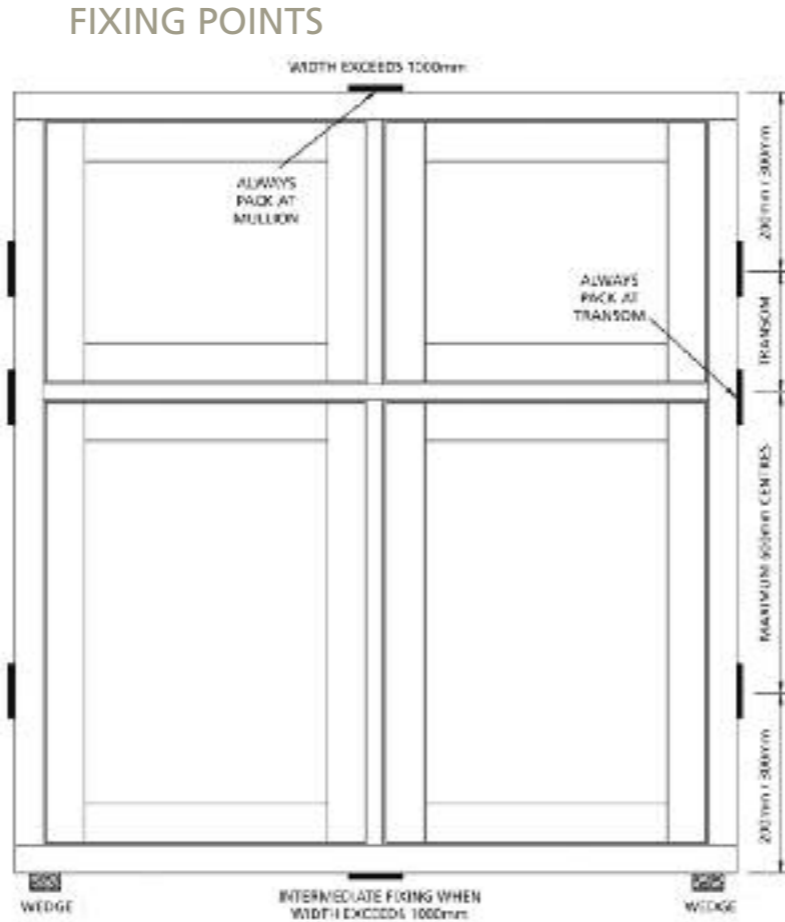

## DOOR / CASEMENT FRAME DIRECT FIXING

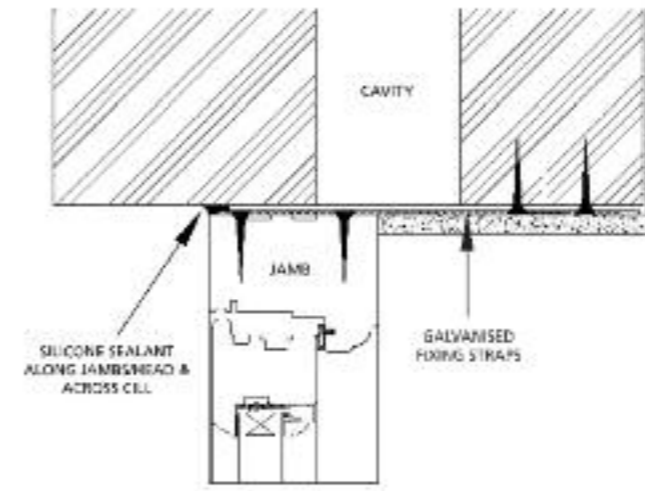

## DOOR / CASEMENT FRAME STRAP FIXING

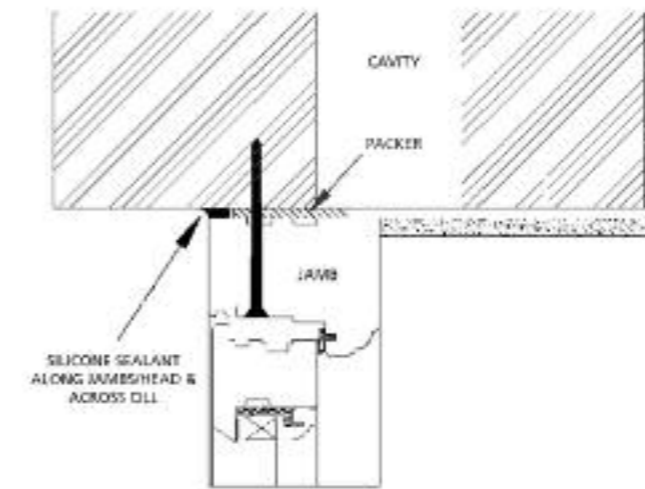

## FOR SITE LINKING CASEMENT FRAMES OR SITE FIXING CILL EXTENSIONS

- Provide additional fixing to head and cill on units over 1000mm wide.
- Check diagonal frame dimensions are the same and product functions properly.

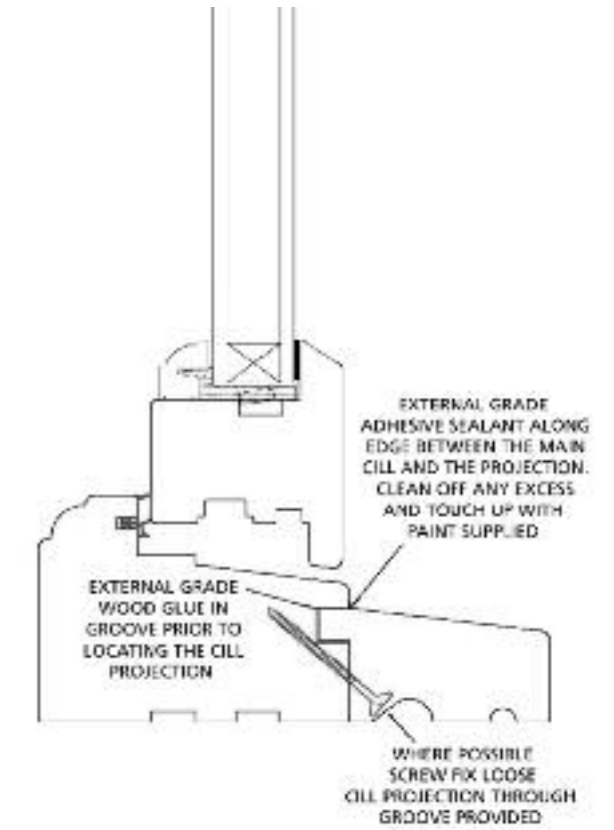

## SITE LINKING CASEMENTS

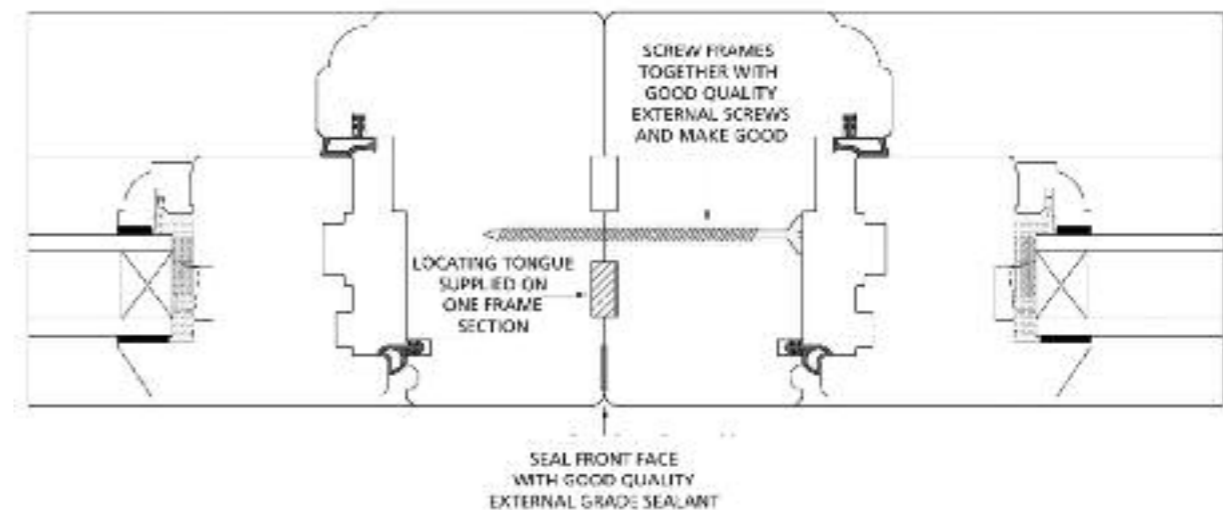

# CONSERVATION™ CASEMENT WINDOWS

## SIDE-SWING: REMOVAL & INSTALLATION

### HINGE SYSTEM SIDE SWING

- If sash needs to be removed just remove all screws, preferably bottom first, and support the sash to avoid damage. Two people may be needed.
- When reinstalling you will need two people.
- To adjust the window at either end of the hinge there are elongated slots.
- Offer sash up to the frame and then fix using the outer holes of the hinge.



- The tolerance around the sash should be 4mm.
- Then fix using locking holes; these may differ for different hinges.



### SIDE HUNG REMOVAL & INSTALLATION

- Open sash, then unscrew the stay at the top of the sash.



- Then lift off from the butt hinges.



- These hinges are factory adjusted and should not need further adjustment.
- To reinstall, lift back onto the butt hinges and reinstall the friction stay. Two people may be required.



# CONSERVATION™ DOORSETS

## DOOR FITTING & ADJUSTMENT

- When doors arrive out of frames they are marked up for their specific frame. These marks can be found under the hinge position on frames and doors with a corresponding letter and have a label on the glass with the item number.
- If the door is on lift-off hinges you will need to lift the door onto the hinges and attach the friction stay at the top of the door.
- If you have fixed pin hinges you will need to put a packer under the door at a height that you can easily fix the hinge onto the frame. The frame has screws and a 1mm packer already fixed. Remove these and replace the packer. Offer up hinge and re-fit. Avoid over tightening the screws.
- The packer is there for seasonal adjustment and can be taken out, or added, when needed.





# BI-FOLDING DOOR INSTALLATION

## FRAME INSTALLATION

### LINTEL SPECIFICATION GUIDE

- Lintels must have at least 150mm structural bearing to each end. The overall length of a lintel should at least be the sum of the opening width plus 300mm (minimum).
- The safe working load for the lintel must not be exceeded by the combined loads imposed by the structure and the loads imposed by the Bi-folding doorset.
- When specifying the lintel it will also be necessary to advise the type of construction, the type and thickness of the inner and outer leaves and the width of the cavity. It will also be necessary to advise the exposure rating for the site to determine if a cavity tray is required.
- The additional loads imposed by the Bi-folding doors will be a uniformly distributed load (UDL) of 0.5kN (approximately 50kg).
- Loads imposed by the structure will include loads from roof trusses, floor joists and masonry.



### JAMB FIXING

The jambs should be fixed using five fixings evenly spaced to suit brickwork.

### CILL FIXING

We recommend that the cill is fixed in at least three places evenly spaced along the length of the cill and fixed in place to the sub floor. This will have to be through the wooden part of the cill.

### HEAD FIXING

DOOR WIDTH	FIXING POSITION MEASURED FROM EITHER END																					
1800	100	175	250	325	400	700	1000	1400	1475	1550	1625	1700										
2100	100	175	250	325	400	700	1100	1300	1700	1775	1850	1925	2000									
2400	100	175	250	325	400	700	1100	1600	2000	2075	2150	2225	2300									
3000	100	175	250	325	400	700	1100	1500	1800	2200	2600	2675	2750	2825								
3600	100	175	250	325	400	700	1100	1500	1900	2400	2800	3200	3275	3350	3500							
4200	100	175	250	325	400	700	1100	1500	1900	2300	2600	3000	3400	3800	3950	4025	4100					

### STEEL GIRDER INSTALLATION

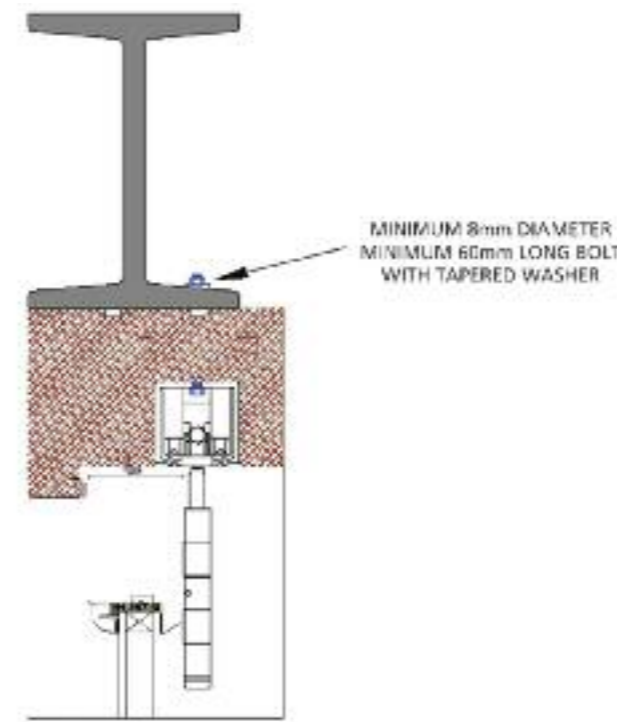

### TIMBER LINTEL INSTALLATION

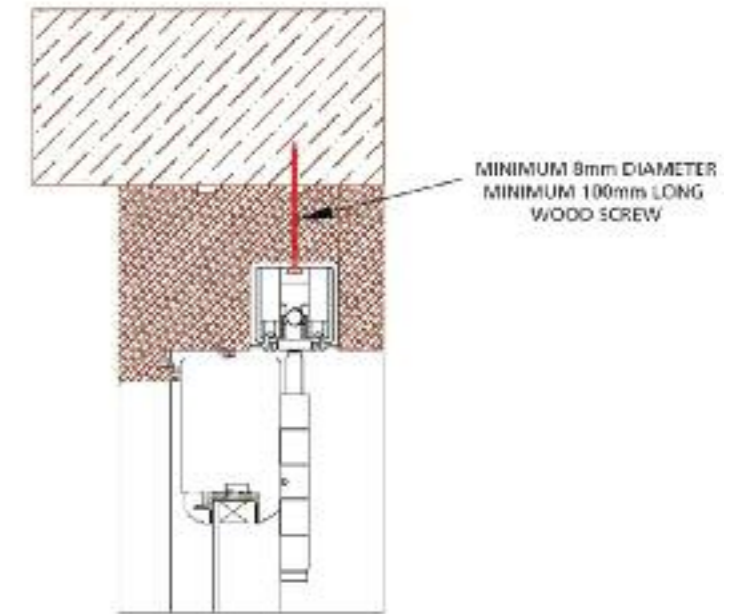

### REINFORCED CONCRETE INSTALLATION

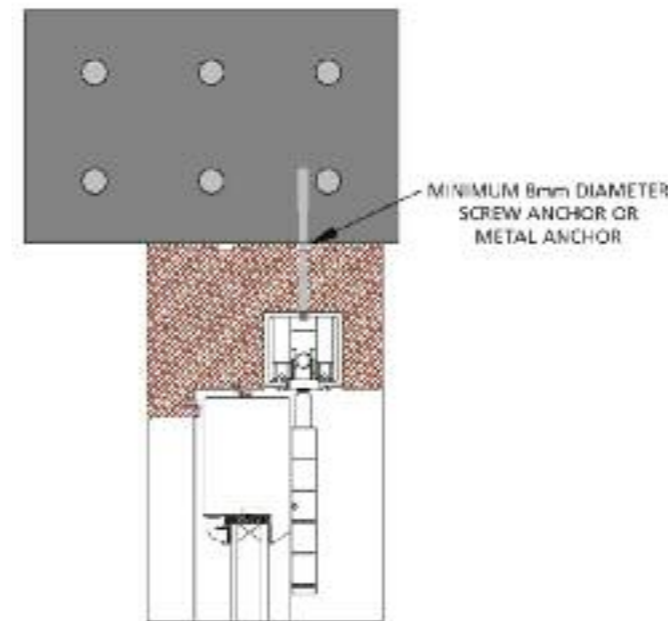

### NEW BUILD LINTEL INSTALLATION

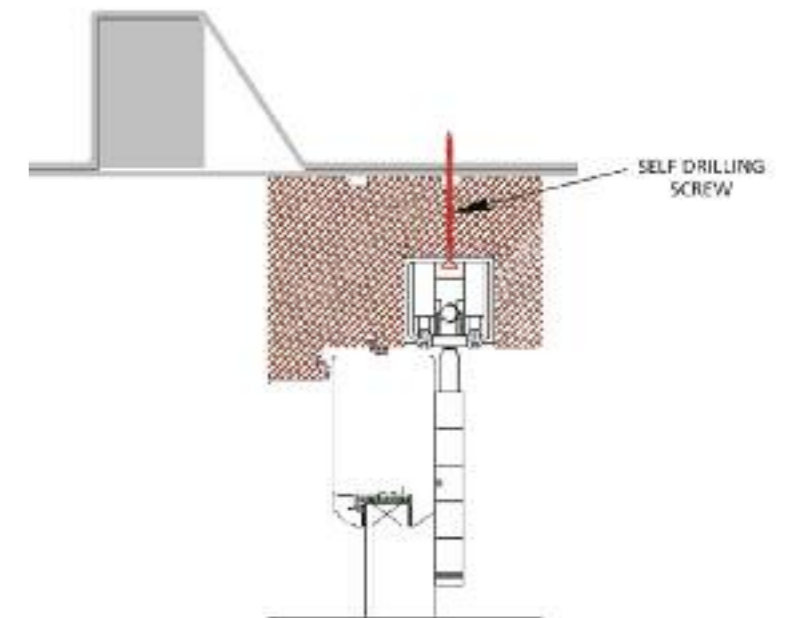

■ Your Bi-folding door must be supported from the top with adequate fixing points or your frame will sag in the middle. This in turn will impede the doors from opening or closing correctly and will affect the weatherseals and damage the doors and internal flooring.

■ Please ensure that your frame has been fitted correctly as this could affect your Warranty. The fixing measurements provided are a guide only.

# BI-FOLDING DOOR INSTALLATION

## BI-FOLDING DOOR ADJUSTMENT



■ For height adjustment, that is, to raise the door up or down, there is a small button to push as indicated.



■ This allows the spindle of the hinge to be raised or lowered with an allen key that comes with your fitting box.

## FOR ADJUSTING GAPS IN YOUR DOORS



■ For the bottom track loosen allen bolts then adjust the middle bolt. This has a cam action that moves the door in and out.



■ For the top track loosen allen bolts to move the hinge sliding the gear backwards or forwards to achieve the correct tolerance.



# MAINTENANCE, CARE & PROTECTION OF YOUR PRODUCTS

## PLEASE ENSURE YOU HAVE READ & FULLY UNDERSTOOD THE FOLLOWING:

Windows are installed in accordance with our instructions. Please check that there is no damage to the coating, such as chipping, staining, etc.

Should the coating become damaged when the windows are installed, the coating should be promptly repaired in accordance with our remedial coatings instruction, which is covered in this section.

The coating is cared for in such a way that it is not damaged by abrasion, for example, window cleaner's ladders.

The coating and surrounding area are not cleaned with strong chemicals.

The coating is cleaned at specific intervals so that dirt retention does not lead to excessive mould growth. Such mould growth is likely to occur on north facing elevations.

Only coatings recommended by Mumford & Wood are applied to the joinery.

Please follow the correct coatings maintenance schedule.

## Care & Protection

With the correct care and attention, your factory finished products will give extended life between redecoration cycles. To achieve this performance, the following should be observed:

At least once a year all coatings should be washed with mild detergent and water to remove surface pollution.

All hinge mechanisms and handles should be checked at least bi-annually for ease of operation and lubricated as required with light oil suitable for the purpose.

Weatherseals should be cleaned at least once a year to remove dust or grime to maintain the performance of your products.

Ventilators should be cleaned at least once a year to remove dust and grime that may affect their performance.

## Surface coatings

Our windows and doors are coated with high performance, water-based, micro-porous, spray applied coatings. With minimum maintenance they will give decades of service.

The coating should be washed down with clean water to remove dust, insects and other contaminants as these can form a base for fungal growth. The coating should then be inspected for any damaged areas which should be repaired using the following procedure:

Abrade the damaged area with fine-grade sandpaper.

Clean down and wash abraded area to remove dust and allow to dry thoroughly.

Using a good quality synthetic brush, designed for use with acrylic paints, apply a coat of high performance, water-based, micro-porous, spray applied coating applied in the appropriate shade/colour to match the damaged area. Allow to dry for four hours and then apply a second coat.

If the damaged area is widespread, it is recommended that the whole frame is abraded and repair as described above with the second coat applied to the complete frame.

## Where moisture has penetrated joints, end grain or mitres, or natural movement of timber has opened shakes in wood

Abrade the damaged area with a medium-grade abrasive paper and follow with a fine-grade abrasive paper.

Clean down and wash the abraded area to remove dust and dirt then allow to dry thoroughly.

Prime with a high performance, water-based, micro-porous, spray applied coating in the original colour or stain.

Seal any end grain with end grain sealer. If there are any gaps to be filled use an acrylic sealant that can be over-painted.

Then repeat the process for top coat as described in the previous section.

## Where damage has affected the full depth of the coating creating a deep gouge

The full system requires repair. The gouge should be abraded and filled with good quality wood filler. Leave to dry then sand down to a good finish and prime using a high performance, water-based, micro-porous, spray applied coating.

Then using a good quality synthetic brush apply a single coat of high performance, water-based, micro-porous, spray applied coating. Leave for four hours and then give it a final coat.

## Where the coatings system is intact but requires a cosmetic upgrade

Lightly abrade the damaged area with a fine-grade abrasive paper.

Clean down and wash the abraded area to remove dust and allow to dry thoroughly.

Then give two top coats as described in previous section.

## Where resin has exuded through the coating

The best remedial treatment is to allow it to weather until it dries and oxidises forming a white crystalline powder. Then the resin can be removed with a stiff nylon brush and the remaining residue washed off with a cloth.

Water-based coatings with their relatively high degree of moisture vapour permeability often allow the passage of resin to the surface without damage to the coating. If the finish is not damaged by over vigorous scrubbing during crystalline removal, re-coating is often unnecessary.

Although it may be unsightly it is better not to remove fresh sticky resin. In practise this can be very difficult and the presence of sticky resin indicates that the exudation is still continuing. The remedial work for resin exudation is often best left until the first maintenance period by which time the resin has fully crystallised. After removal as described above the overall application of one maintenance coat of finish will restore the general appearance of the timber and maintains its protection.

When carrying out any coating work do not attempt to paint when the temperature is below 8°C or if the relative humidity exceeds 85% as curing of the coatings may be impaired.

## Stained/dark coloured paint

These items will be palletised rather than individually bubble wrapped.

The use of dark coloured stains and opaque colours will have an impact on maintenance intervals and the level of maintenance work required. Dark colours absorb more of the sun's energy which can accelerate the degradation of the coating film, and the impact of high surface temperatures can mobilise natural resins within the timber substrate. This can lead to blistering of the coating. The amount of differential movement between components will also increase resulting in open joints and possible moisture ingress if not rectified.

Annual inspections and preventative maintenance in line with the instructions in this manual will ensure the long term performance of the product.

Due to the natural characteristics and variation of surface texture within the same species of timber, there will be colour and/or grain variations between component parts. Certain manufacturing processes will also be evident when translucent stains are used.

## Glazing

Mumford & Wood's products are factory glazed under controlled conditions to maintain the integrity of the vented and drained system for guaranteed sealed units. This method also ensures a high degree of security against unwanted de-glaze from outside. Re-glazing should only be necessary in the case of site damage or breakage. We recommend the following course of actions and options:

■ Re-order a complete new sash for replacement by a carpenter or a Mumford & Wood service engineer.

■ Mumford & Wood service engineers replace glass on site.

■ Site glazier re-glazes the product however in these circumstances Mumford & Wood will not Warranty the product function, or bar adhesion.

In the unlikely event of a unit failing please refer to the Company's Warranty and Terms & Conditions.



# WARRANTY

Thank you for choosing Mumford & Wood products which are manufactured to high and exacting standards.

This product Warranty is applicable from the agreed delivery date for up to 10 years and is subject to Mumford & Wood Limited standard Conditions of Sale.

Projects relevant to you, technical downloads, case studies, together with our latest product developments can be found on our website at: [www.mumfordwood.com](http://www.mumfordwood.com)

## THIS PRODUCT WARRANTY COVERS ITEMS DETAILED BELOW:

### Wood frame & sash

The Company warrants that all wood components are free from defects in workmanship and materials that could affect performance for a period of 30 years.

### Surface treatment

The Company warrants that the standard three coat opaque finished joinery is warranted for up to 10 years and the stain finishes up to 6 years against blistering or flaking but excluding natural resin exudation and movement around knots. Regular maintenance should be carried out as specified in the surface coatings maintenance section of this manual. Consideration should be given to the effect extreme climates can make on the lifespan of surface coating. Please refer to the Climate Guideline chart.

### Ironmongery & seals

The Company warrants hinge systems and handles for a period of 10 years against functional failure. Surface finishes for ironmongery are not covered by this Warranty. Replacement ironmongery will be supplied and fitted under Warranty within one year of delivery after which replacements are supplied for the customer to fit.

### Sash window spring balance

The Company warrants the spring balance mechanism for a period of 10 years against functional failure. If the failure occurs in the first five years of the Warranty period the Company will supply and fit a replacement balance, but if this occurs in the second five years the Company's obligations are limited to supplying the replacement balance but not the cost of installation.

### Double glazed units & glass

The Company warrants that the glass will comply with the Glass and Glazing Federation's visual quality standards.

The Company warrants that seals on double glazed units will be free from failure (failure is taken to mean failure of the insulated glass unit resulting in penetration of moisture into the air space and appearance of moisture on the glass inside the airspace) for a period of 10 years from delivery. If the failure occurs in the first five years the Company will be responsible for the supply and fitting of replacement glass units. If failure occurs in the second five years then the Company's obligations are limited to supplying the unit only.

The Company reserves the right to supply a whole sash as an alternative to supplying glass for re-glazing on site. No other glass defect or phenomena are covered by this Warranty.

## Exclusions to this Warranty

■ Damage to the surface coating has occurred by physical damage, for example damage caused by window cleaner's ladders, damage to cill extension joints by handling or installation, pet damage, chemical damage, damage caused by bad maintenance or poor design of building.

■ Where non-standard paint finishes were ordered by the customer in which case the warranties for the surface coatings only extend for the following period:

Two coat finish - **three years**

One coat primer - **three months**

Three coat translucent stain - **five years**

Two coat translucent stain - **one year**

■ Where damage has occurred as a result of faulty installation, repairs, alterations, work processes or pollution from surrounding areas.

■ Where damage has occurred from excessive cleaning processes or hosing down of product.

■ Where products have been stored in an unventilated area prior to fitting or areas that have been unventilated during the construction process.

■ Where products have been used in swimming pool areas without correct paint coating.

■ Where damage that is caused by external causes outside the control of the Company which shall include, accident, fire, disaster, burglary.

■ Where products have been exposed to unusual physical conditions.

■ Where surface wear has been caused by natural elements.

■ Where cill projections exceed 85mm.

■ Where any sums remain due to the Company.

**Provided always** all surface treatment warranties are subject to environmental conditions as stated in our coatings information to ensure that the product has been maintained in accordance with the Company's Warranty conditions.

## Claims procedure

In the unlikely event you believe you have a valid claim please contact Mumford & Wood and request a claims form.

## Validation

It is necessary for the customer to substantiate the date of delivery and provide proof of purchase.

## The Warranty covers the coatings against:

Peeling.

Cracking (over greater than 5% of the coated area).

Damage resulting from fungal growth within the coating.

Significant 'yellowing' of the coating.

Premature erosion of the film leading to areas of exposed timber.

## It does not guarantee against:

The exudation of resin.

Extractive staining around knots.

## CLIMATE GUIDELINE CHART

	MODERATE Typically non-coastal areas at low altitude	HARSH Exposed inland locations and areas within 0.5 miles of the coast	EXTREME Areas of high altitude and exposed coastal sites
SHELTERED e.g. beneath porch or large roof overhang	<b>10 YEARS</b> For opaque coatings, 6 years for translucent coatings	<b>8 YEARS</b> For opaque coatings, 6 years for translucent coatings	<b>7 YEARS</b> For opaque coatings, 5 years for translucent coatings
PARTLY SHELTERED e.g. window built back in reveal	<b>8 YEARS</b> For opaque coatings, 6 years for translucent coatings	<b>7 YEARS</b> For opaque coatings, 5 years for translucent coatings	<b>6 YEARS</b> For opaque coatings, 3 - 4* years for translucent coatings
NOT SHELTERED e.g. face of building	<b>7 YEARS</b> For opaque coatings, 5 years for translucent coatings	<b>6 YEARS</b> For opaque coatings, 3 - 4* years for translucent coatings	<b>5 YEARS</b> For opaque coatings, 3 - 4* years for translucent coatings

\*3 years for light shades e.g. Pine and Light Oak.

Copyright © 2014 Mumford & Wood Limited. All rights reserved.

The Mumford & Wood logo is a registered Trademark of The Performance Timber Products Group.