



neaco

norton engineering alloys co ltd

neaco spectrum range

the range from NEACO

With NEACO's Spectrum range of modular handrails, balustrade, structural glass and balconies, every detail reflects NEACO's commitment to the highest design and material quality - supported and enabled through a proven 10-step process, from specification to sign-off.

NEACO's unrivalled service: **10 steps to modularity**

- 1 Specification: sales and technical support ensures the specification meets your design needs and budget.
- 2 Quotation: fully inclusive detailed quotation for manufacture, delivery and installation.
- 3 Pre-let meeting: full review of quotation and sample approval.
- 4 Order: full order review to check design, specification and programme.
- 5 Site survey: CAD designer who details your scheme also measures on site to ensure accuracy.
- 6 Layout drawings for customer approval: a final submission to ensure nothing has been missed.
- 7 Manufacture: engineered in our factory, then full inspection before protective sleeving is applied.
- 8 Pre-installation checks: risk assessments and method statements supplied to site and installation programme re-checked.
- 9 Installation: our own installers fit the product (no manufacture or hot works are required on site).
- 10 Sign-off: once completely satisfied, you sign off the installation and the protective sleeving is re-applied.

contents

1. Stanchion design options	5 - 16
2. Spectrum aluminium in solid and metallic colours	17 - 21
3. Timberline aluminium in a wood-effect finish	22 - 23
4. Spectrum stainless steel	24 - 25
5. Duplex aluminium/stainless steel combination	26 - 27
6. Clearline structural glass	28 - 29
7. R2R rail to ramp system	30
8. Clearview, Classic & Elan balconies	31 - 37
9. Technical & specification data	38 - 48



All NEACO products come with our class-leading Lifetime Guarantee - for details please visit www.neaco.co.uk



- **key attributes & benefits**

1. 100% accuracy and uniform quality through factory manufacturing.
2. Durable, hard-wearing & maintenance-free.
3. Huge range of standard and bespoke components and infills to meet virtually any design.
4. Meets all relevant Building Regulations.
5. Modular connection with internal fixtures providing smooth, clean lines for comfortable touch and high aesthetic value.
6. Fast, low-energy installation with no welding/hot works.
7. Manufactured in accordance with BS 6180: 2011.

stanchion design options



- Centric options
 - powder coated aluminium
 - satin finish stainless steel
 - Duplex combination



- Quad options
 - powder coated aluminium
 - satin finish stainless steel
 - Duplex combination



- ▲ Shape options
 - powder coated aluminium
 - Duplex combination



- ▮ Slim options
 - powder coated aluminium
 - satin finish stainless steel*
 - Duplex combination*

*note: Stanchion component parts are aluminium

Centric





Centric glass



Centric mesh



Centric perforated



Centric offset



Centric tension wire



Centric railed infill

Quad





Quad glass



Quad mesh



Quad perforated



Quad offset



Quad tension wire



Quad railed infill

Shape





Shape glass



Shape mesh



Shape perforated



Shape tension wire



Shape railed infill

Slim





Slim glass



Slim perforated



Slim tension wire



Slim railed infill

Elan

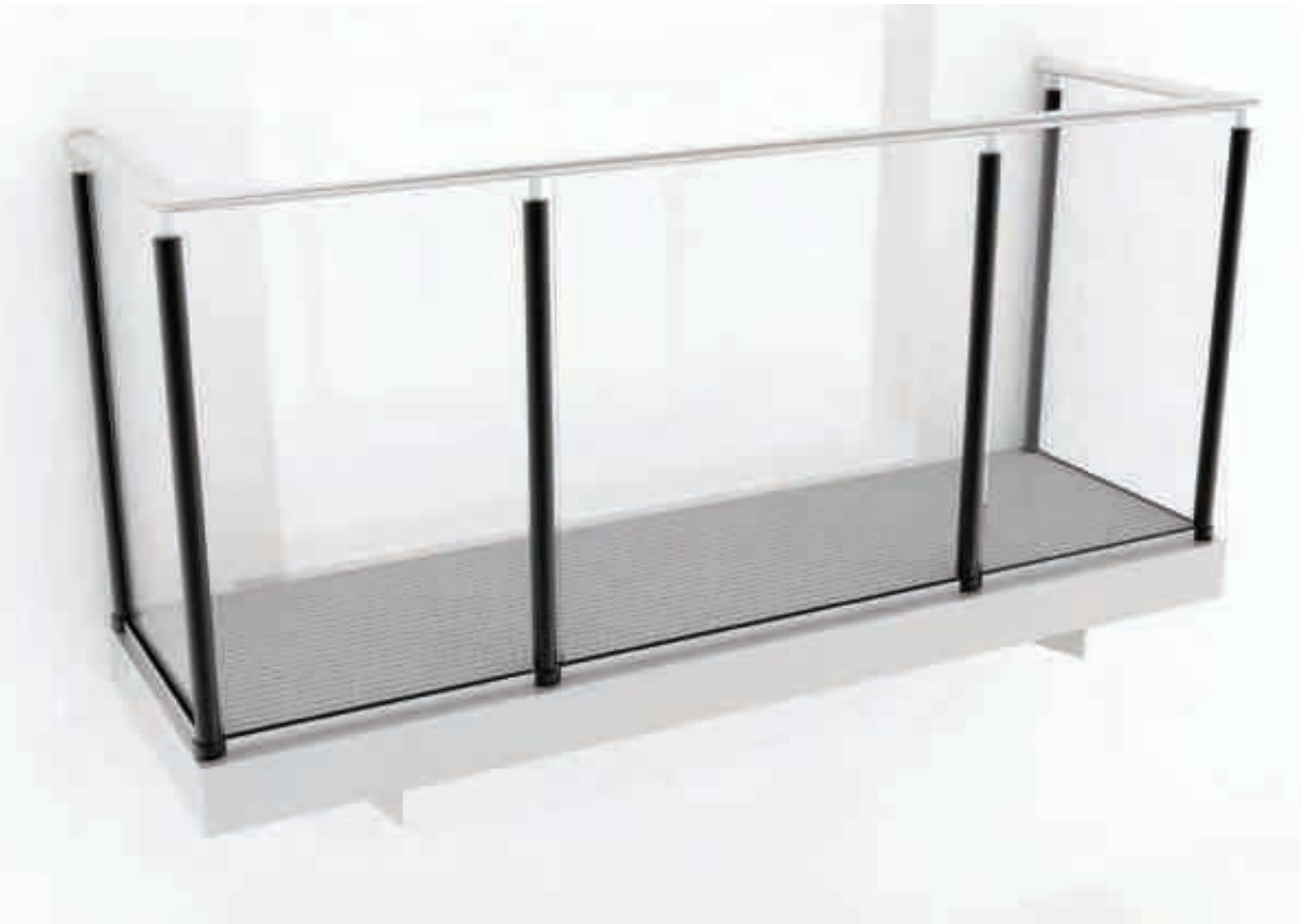



Luxury apartments featuring
NEACO's balustrade, balconies
and solar shading systems.





Products part 1:
Modular
Balustrade
Systems

Spectrum powder coated aluminium

NEACO's Spectrum powder coated aluminium is our original system and it remains our most widely specified handrail and balustrade product. It's easy to see why: clean lines, a beautiful satin-smooth finish, hard-wearing qualities, excellent insulation properties and a warmth and comfort to the touch, even in the most extreme conditions.

Over the years we've developed a wide range of finishes, from an eye-catching choice of standard RAL colours complementing a variety of design schemes to an array of metallic colours which bring a contemporary sheen to all types of built environment.

Like all Spectrum systems, components are connected internally so you don't need to worry about anyone tampering with external fixtures or catching their hands on a screw.

Maintenance-free durability is one of the powder coating's most valuable attributes: it's non-chip, abrasion resistant and provides complete protection from corrosion to ensure that its smooth, spotless appearance lasts for a lifetime.

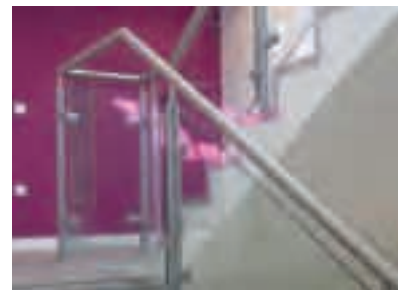



outdoor use

indoor use

powder coated finish

stanchion types



technical and specification
data pages 39-41

project spotlight: Equinox House, Glasgow

This prestigious commercial development extensively features Spectrum aluminium balustrade on external terraces. GD Lodge Architects chose our Slim stanchion option as well as our Techdek aluminium open grilles for cleaning access walkways.





project spotlight: The Street, Scarborough

NEACO supplied a bespoke specification for our Spectrum aluminium balustrade at The Street, a £6.5 million world-class youth and community facility. The product is featured throughout the building, including stairwells and an atrium where the balustrade has been extended to twice the standard height to meet special safety requirements.

Timberline wood-effect aluminium

With its traditional style and rich texture, the natural beauty of wood has plenty of admirers. But it also attracts plenty of natural headaches: bacterial absorption can cause infections and surface deterioration also reduces its comfort and safety to the touch. Endless treatment is required to prevent these problems and maintain its aesthetic virtues. Thankfully, NEACO's Timberline gives you the visual appeal of wood grain without the migraine.

By applying advanced powder coating techniques to our aluminium rails, we can reproduce the intricate detailing of timber which, to the naked eye, is virtually indistinguishable from the real thing. But unlike the real thing, the finish is non-absorptive, warm and safe to the touch and non-chip. When you choose Timberline, you get peace of mind knowing that the installation is maintenance-free - no repairs, no hygiene concerns, no site visits, no more expense.

Available in medium oak or light oak, in a matt or gloss finish, a Timberline handrail combines superbly with NEACO's metallic balustrade and rail infills, either in aluminium or stainless steel.





outdoor use

indoor use

powder coated finish

stanchion types



technical and specification
data pages 39-41

Spectrum stainless steel

If you're looking for a high-specification, high-aesthetic solution to create a prestige appearance, Spectrum stainless steel has all the credentials.

Its visual appeal is the result of careful application and attention to detail. The stainless steel is hand finished and satin polished. Clean, sharp intersection lines are created by true unidirectional polishing. We provide different grades to suit different environments as required - typically Grade 304 for dry internal use and Grade 316 for external use.

A huge range of cast components are precision-engineered by the same manufacturing resources as our aluminium systems, so you get uniform quality and flawless accuracy throughout. They also offer the same maintenance-free durability. For design versatility, striking aesthetics and premium material quality, Spectrum stainless steel offers a combination without peer.



outdoor use

indoor use

satin polished finish

stanchion types



technical and specification
data pages 39-41



Many specifiers appreciate the merits of our aluminium and stainless steel balustrade in equal measure. It's often difficult to choose between the two, but with our Duplex system you can choose both.

With Duplex you can combine a powder coated top handrail with stainless steel stanchions and infill rails, or choose the reverse combination instead. Either way, the two materials provide an attractive contrast and complement each other superbly within the same modular design solution.

A popular choice is stainless steel with aluminium powder coated in solid black or white, but numerous options work beautifully together - giving you a whole new agony of choice.





outdoor use (with
grade 316 stainless steel)
indoor use
powder coated finish
satin polished finish
stanchion types
● ■ ▲ |
technical & specification
data pages 39-41

Clearline structural glass

Our Clearline structural glass combines strength and durability with smooth, clean lines, minimalist looks and maximum visibility.

The glass is capped by a powder coated aluminium top rail and requires no supporting uprights. Continuous glass is fixed in place by floor channels with integrated rubber seals which insulate the glass and eliminate the need for the more traditional messy mastic detail. We offer a range of aesthetic options including Low Iron glass, tinting, acid etching and applied emblems/logos.

With glass tested in accordance with BS EN12600:2002, Clearline has the durability to cope with high traffic areas and is ideal for buildings likely to be used by children, where safety on staircases and landings is paramount - the system is very difficult for children to climb and there are no gaps through which they could pass. We also provide an alternative option with our new Elan semi-structural glass which secures glass panels in place with a floor channel (instead of using traditional clips attached to stanchions) - please refer to pages 14 & 15 for a visual illustration.



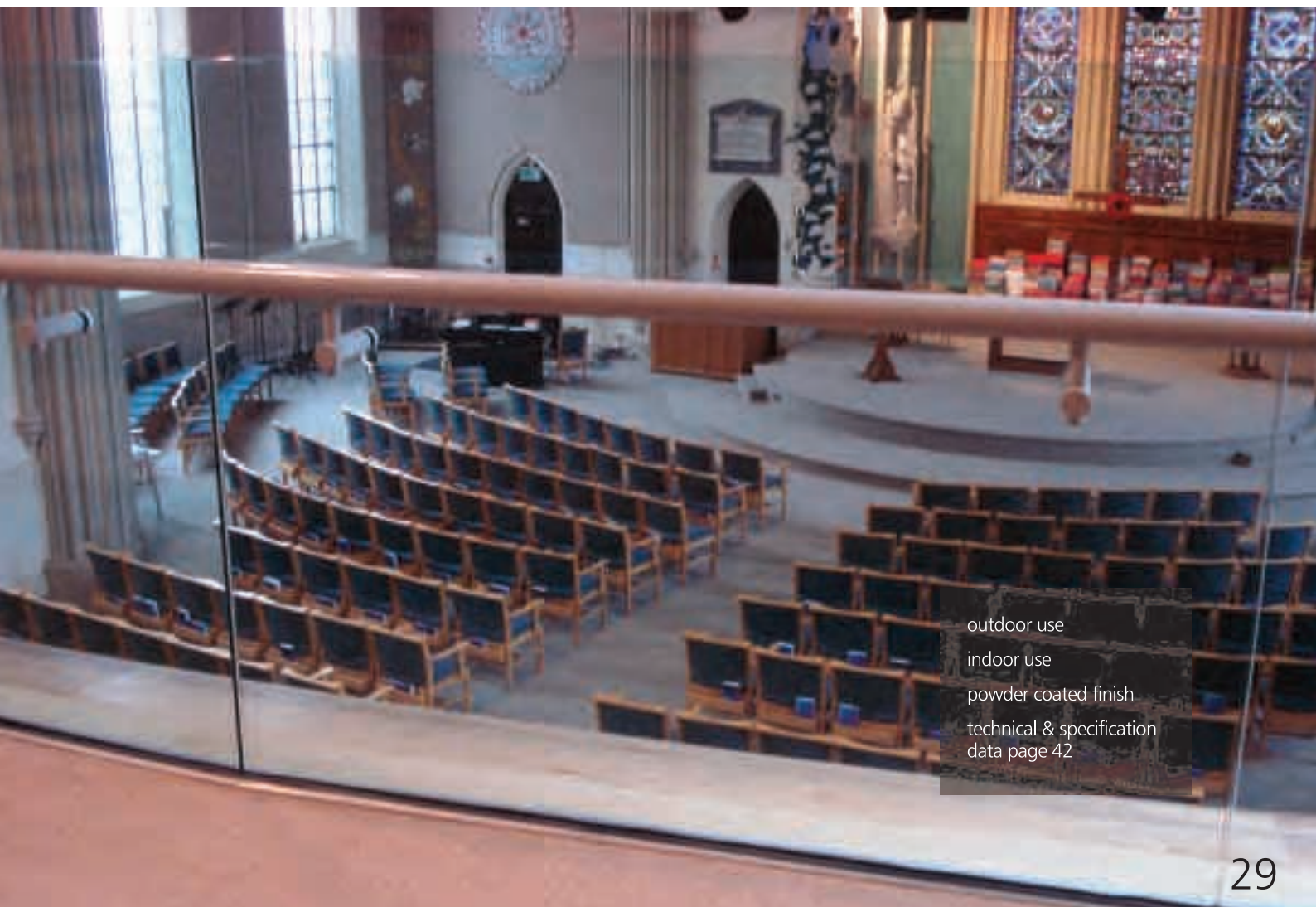

outdoor use
indoor use
powder coated finish
technical & specification
data page 42

R2R (rail to ramp)

Invariably one of the last installations to be scheduled at a development, the completion of ramps with accompanying rails is usually required within a very short timescale. NEACO's adjustable R2R system offers a fast, reliable solution which delivers materials to site within four weeks of ordering.

It's quick and easy - all you need to do is supply a plan with the ramp's approximate length including landing and approach (to within 100mm) plus the positioning of the structure into which stanchions can be grouted. The rail length can be adjusted on site to plus or minus 100mm from ramp drawings and the use of grout in bases means that rail height can also be adjusted.

Technical & specification data page 43.



A close-up photograph of a modern balcony railing system. The railing consists of a dark, cylindrical post mounted on a circular base plate, which is attached to a red brick wall. The railing is positioned against a clear blue sky. The text "Products part 2: Modular Balcony Systems" is overlaid in the upper right corner.

Products part 2:
Modular
Balcony
Systems

Clearview and Classic Juliet balconies

When it comes to designing balconies, we believe every good storey deserves a great finish. NEACO's range of Juliet balconies provides the ideal aesthetic for any building, as well as fast installation, low-energy construction and zero-maintenance.

With a glass-panelled design offering an alternative to unsightly meshed and heavily railed balconies, our Clearview Juliet balconies provide attractively minimalist looks - no stanchions are needed as the glass is secured by a smooth-to-touch top rail and subtle circular brackets underneath (alternatively a bottom rail can be specified if preferred). This means that the view out and the sunlight coming in are both completely unobstructed.

Our Classic Juliet balcony offers a more traditionally-styled design with railed infill. It is ideal for the refurbishment and renovation of older buildings, especially in cases where planning regulations stipulate a railed balcony.

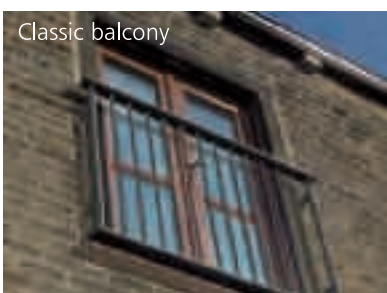
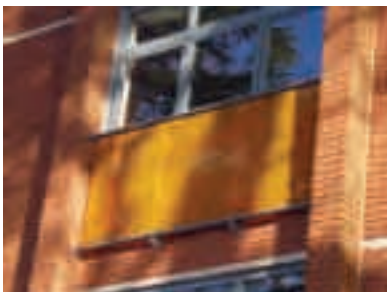



outdoor use
powder coated finish
technical & specification
data page 44

Clearview walk-on balconies

Available in a choice of stylish designs, our Clearview walk-on balconies bring contemporary style to upper floors and genuine kerb appeal for any residential development.

Available in a choice of finishes, these superior solutions include durable aluminium decking with innovative open-grille options which maintain privacy by partially or fully restricting the view from above and below but still allow rainwater to drain quickly and effectively to prevent pooling. Balustrade and handrails are manufactured from powder coated aluminium or stainless steel complemented by glass panel infills.

We are also providing an attractive new balcony option with our Elan semi-structural glass system. The Elan balcony features the same aluminium decking as Clearview and is also available with top rails and balustrade in a variety of finishes - please refer to page 14 for a visual illustration.





Clearview balconies at Hanover Mill, Newcastle

outdoor use
powder coated finish
satin polish finish
stanchion type



technical and specification
data page 45



project spotlight: Luxury apartments

This development features a bespoke design which NEACO can provide outside of our standard balcony specification.



project spotlight: Welland Court, Nottingham

Allan Joyce Architects extensively specified Clearview walk-on and Juliet balconies to provide the subtle visual impact they required at this £8.5 million development of 72 apartments in Nottingham.

Technical information

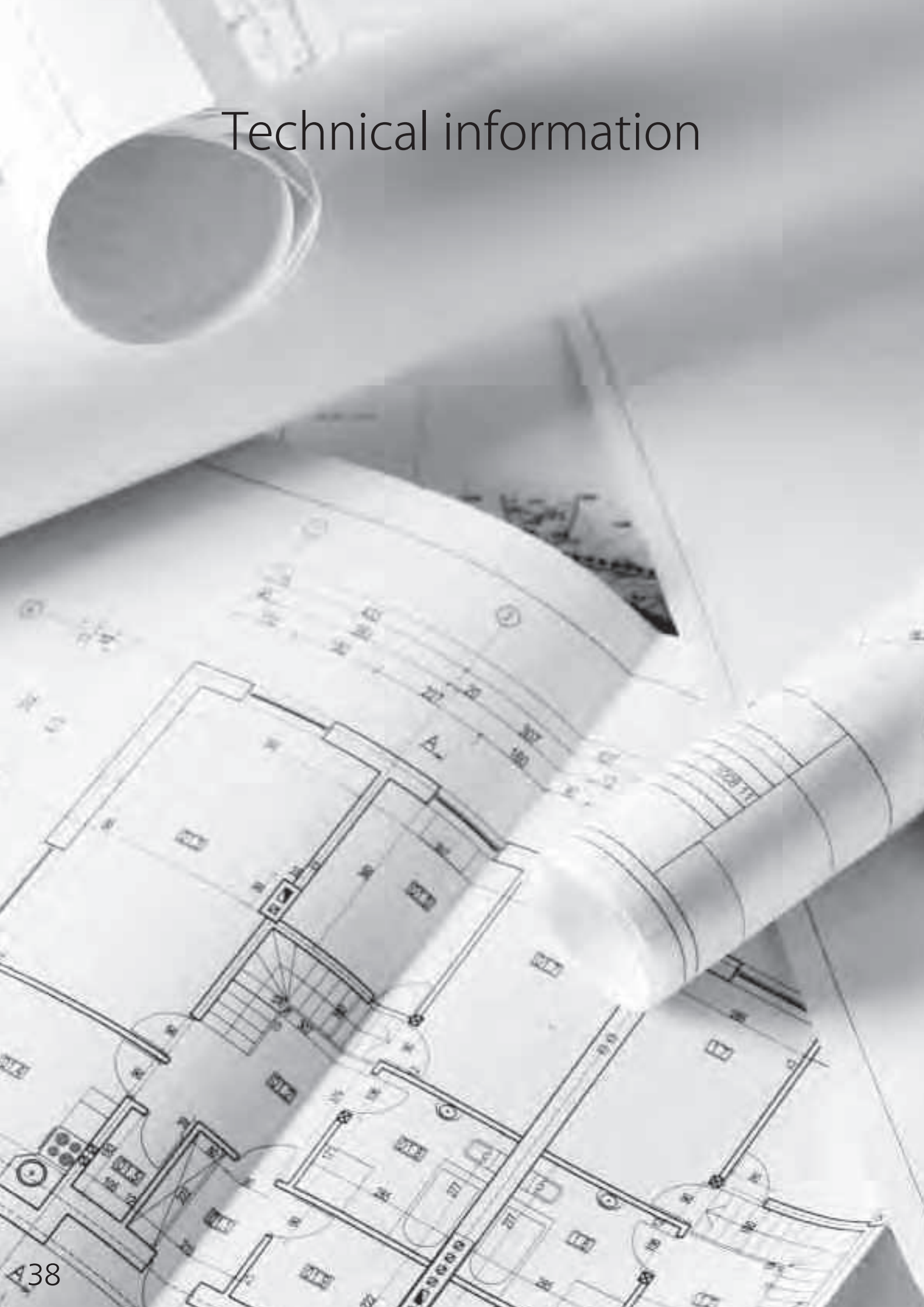

NEACO STANDARD COLOUR RANGE

Handrail & Balustrade



Jet Black
Satin Finish
RAL 9005



Anthracite Grey
Satin Finish
RAL 7016

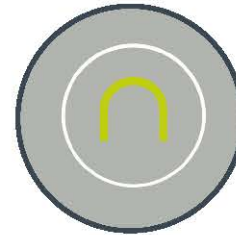

Agate Grey
Satin Finish
RAL 7038



Sapphire Blue
Satin Finish
RAL 5003

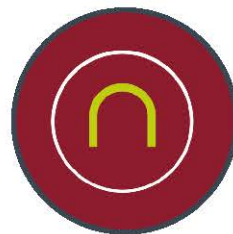

Ruby Red
Satin Finish
RAL 3003

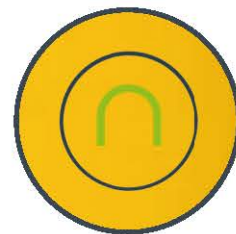

Golden Yellow
Satin Finish
RAL 1004

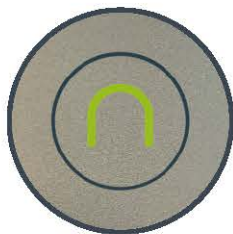

White Aluminium
Satin Finish
Metallic



Tungsten*
Satin Finish
Metallic

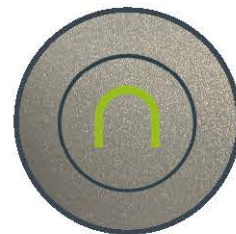

Chromium
Satin Finish
Metallic



Light Oak**
Satin Finish
Timberline



Dark Oak**
Satin Finish
Timberline

Non-standard colours and antimicrobial coatings are available upon request
Additional charge applies to Timberline coatings

*Only available in Nylon ** Only available in Polyester

specification aid

Wall Rail Brackets



Stem Brackets

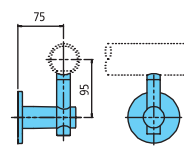

Bend Bracket with Concealed Fixings

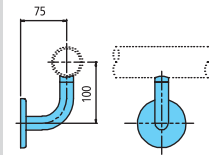

Wall Rail Fitting with Rose

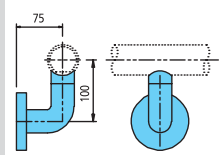

Stanchion Connections



Stem Stanchion Bracket

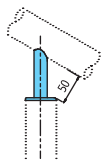

Corner Stem

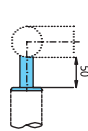

Corner Connector

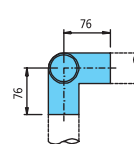

Raked Connector

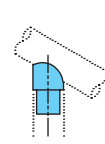

Offset Stanchion Brackets

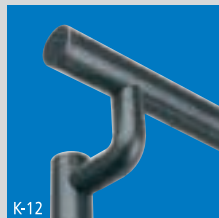

Stem Stanchion Bracket

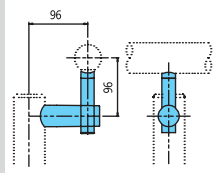

Stanchion Mounted Elbow Bracket

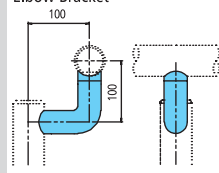

Side Fixed Stanchions

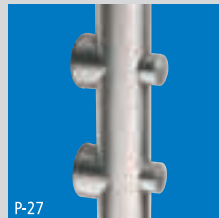

Double Button Side Fix

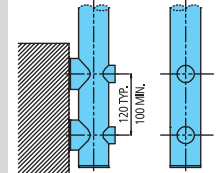

Barrel Side Fixing

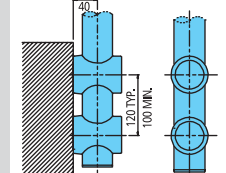

Infill Clips

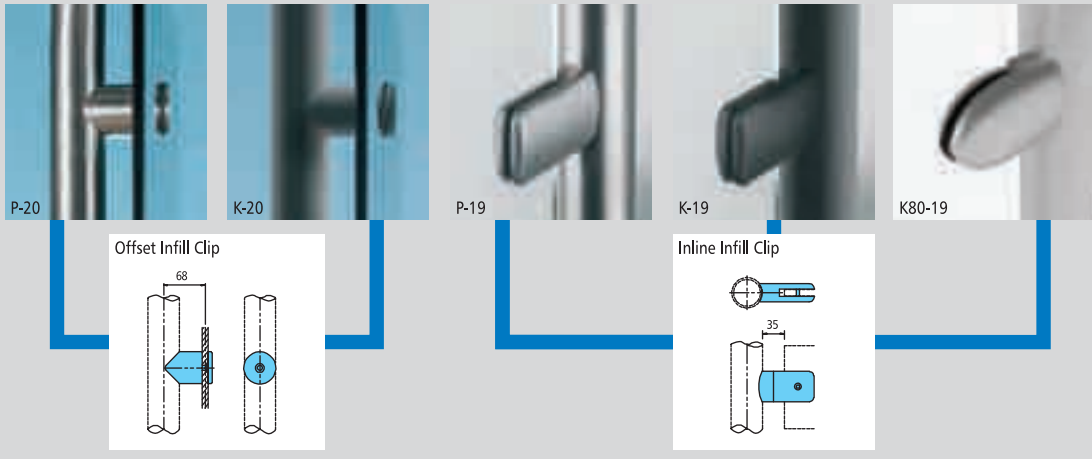

Grout-in Bases

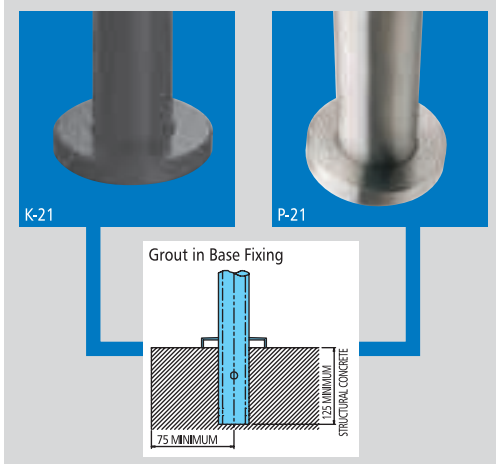

1 Spectrum nylon coated aluminium & Timberline specification

- | Manufactured in accordance with BS 6180:2011.
- | Engineered to close tolerances, with quality formed bends eliminating the need for unsightly mitred joints.
- | Components mechanically secured with concealed fixings, requiring no welding (all fixings are supplied).
- | Electrostatically sprayed powder coating in a choice of RAL/BS solid colours, metallic options or wood-effect finishes.
- | Comfortable and warm to the touch.

Wall Rail Terminations

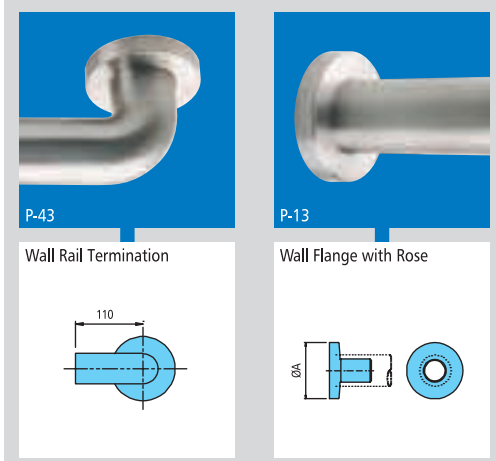

2 Spectrum stainless steel specification

- | Manufactured in accordance with BS 6180:2011.
- | Engineered to close tolerances, with quality formed bends eliminating the need for unsightly mitred joints.
- | Components mechanically secured with concealed fixings, requiring no welding (all fixings are supplied).
- | Available with a choice of infill options.
- | Clean, sharp intersection lines created by true unidirectional polishing.
- | Hand finished, satin polished components.

Clearline structural glass specification

1 Powder coated aluminium extrusion top handrails

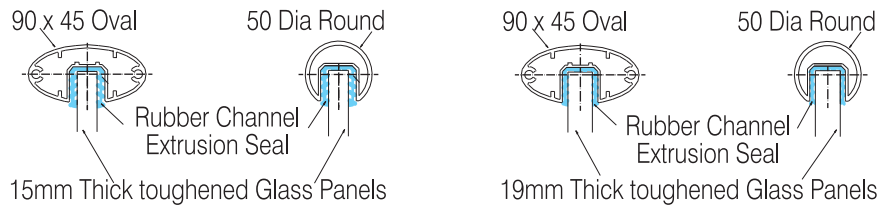

2 0.74 kN/m Bottom channel section

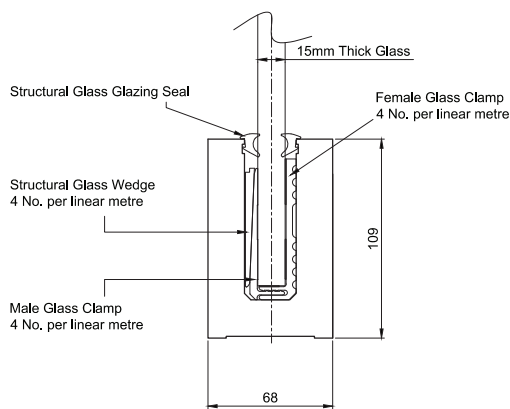

1.5 kN/m Bottom channel section

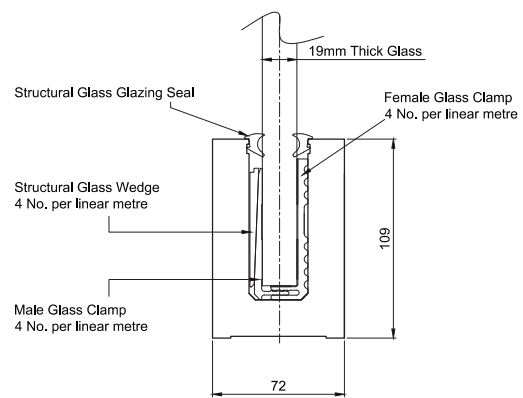

3 Balcony detail

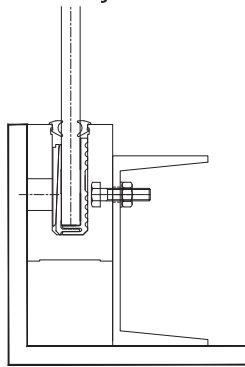

4 Concealed top fixing

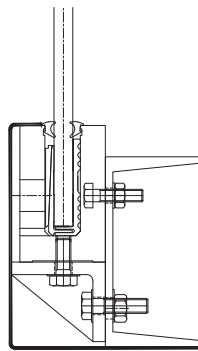

5 Exposed top fixing

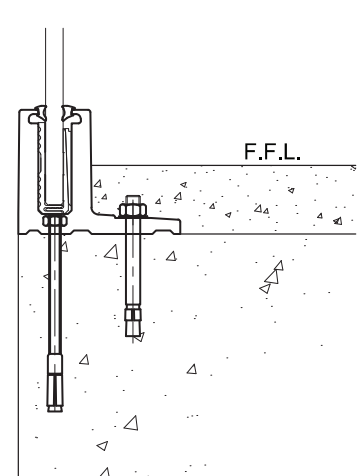

TOUGHENED GLASS in accordance with BS EN 12150-2:2004

We currently offer two systems:

- 1) for 0.74 kN/m horizontal (uniformly distributed) load – min. thickness 15mm
- 2) for 1.5 kN/m horizontal (uniformly distributed) load – min. thickness 19mm

To assess which building categories this covers please refer to Table 4 of BSEN 1991-1-1:2002.

LOW IRON GLASS option is available, offering a noticeably clearer panel than standard clear float glass.

OPTIONAL HEATSOAKING can accelerate crystallisation, reducing the risk of potential breakages when glass is in situ.

CHANNEL BASE is extruded from 6063 T6 aluminium and can be top, flush or side fixed directly to a suitable structure. Top and side fixed bases can be capped or cloaked.

TOP RAIL is oval or tubular in powder coated aluminium (6063 T6) providing a warm to touch finish in cold winter conditions in accordance with clause 5.10.1 of BS 8300.

R2R (rail to ramp) specification

1 Our balustrade is made to suit all the legal gradients:

LIMITS FOR RAMP GRADIENTS (Ref BS8300 & Doc M)		
RAMP LENGTH	MAX GRADIENT	TOTAL RISE
10m	1:20	500
5m	1:15	333
2m	1:12	166

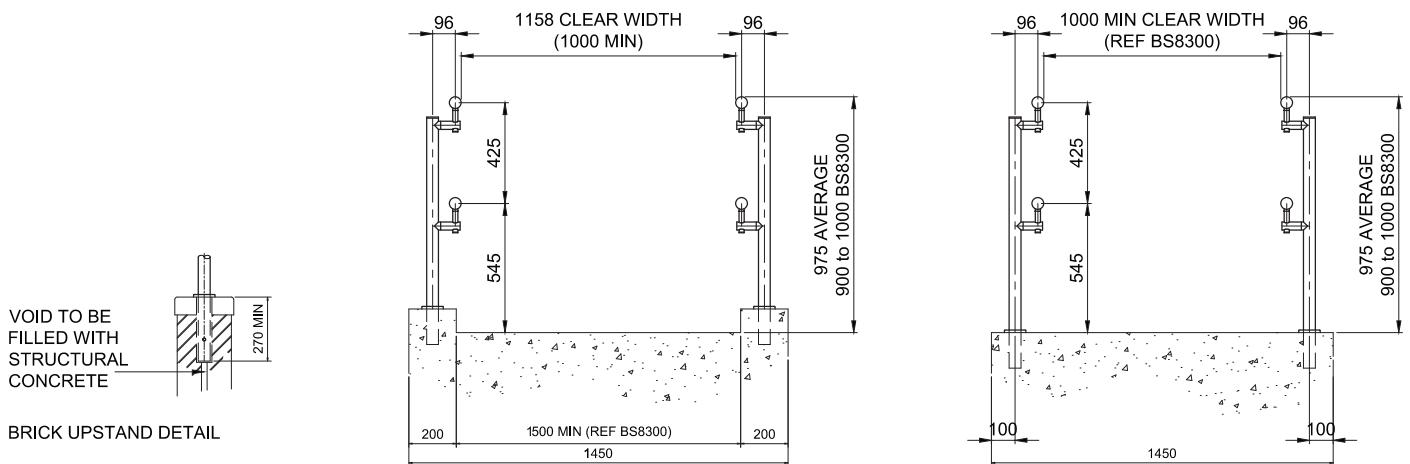
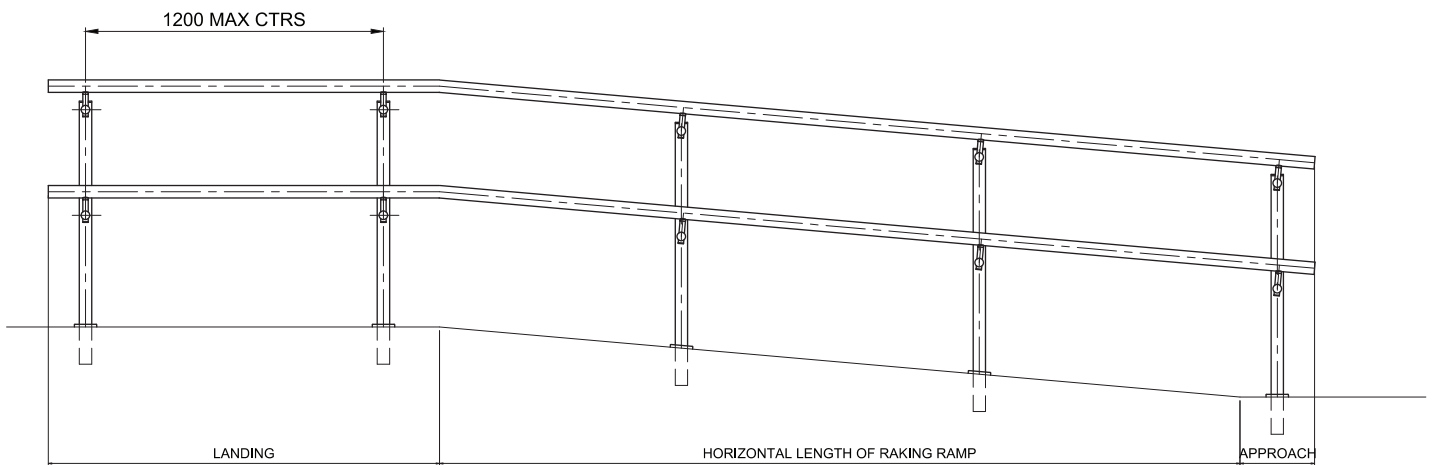

Clearview and Classic Juliet specification

The maximum span for a uniformly distributed load of 0.74 kN/m is a 2.5 metre masonry opening.

In accordance with BS 6180:2011 the balustrade is designed to meet the minimum horizontal imposed loads stated in BSEN 1991-1-1:2002. Fixings are not supplied - these are to be determined by the project's structural engineers on the assumption that the wall construction is capable of withstanding the applied load.

1 Clearview Juliet balcony

TOP HANDRAIL 90mm x 45mm oval aluminium alloy top rail with a range of powder coated finishes. Rail connected to the wall structure by means of circular stem brackets with rose covers.

INFILL Top rail encapsulates 10mm thick toughened safety glass panels (1200mm high x minimum 900mm width) with clear or tinted options. Glass panels secured at the base with a minimum of two circular support brackets.

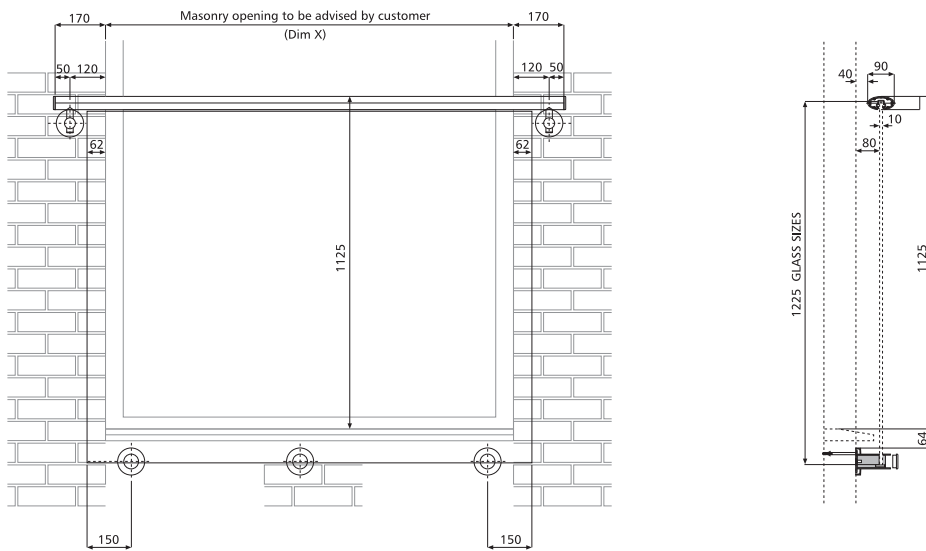

2 Classic Juliet balcony

TOP HANDRAIL & BOTTOM RAIL 90mm x 45mm oval aluminium alloy with powder coated finish.

STANCHIONS 50mm diameter stanchions connected to each end of top and bottom rails. Balcony connected to the wall structure by means of four tubular connectors fixed to top and bottom of each stanchion (all components aluminium alloy with powder coated finish in a wide range of colours).

INFILL 22mm vertical rails in aluminium alloy with range of powder coated finishes.

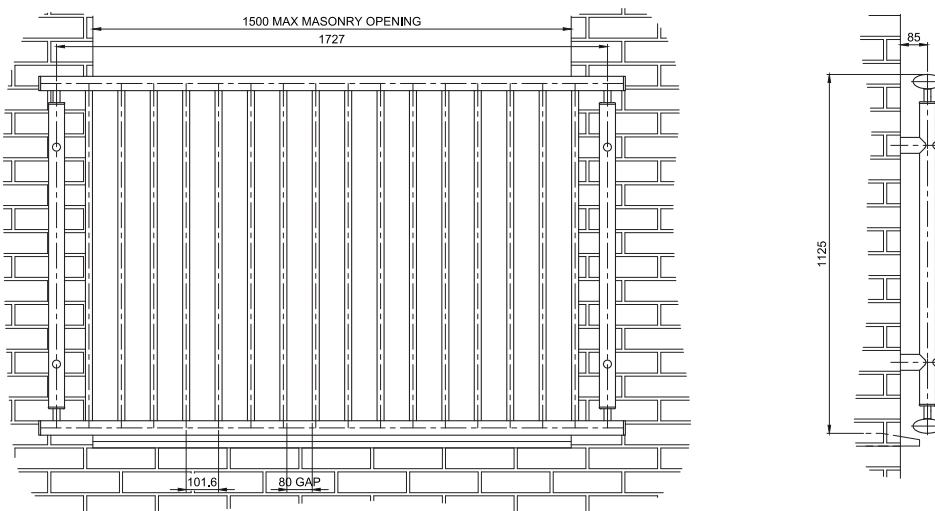

Clearview & Elan balconies specification

FRAME 152mm x 51mm aluminium alloy (mill finish).

FLOORING 25mm deep aluminium alloy (mill finish) with 5mm gap banded on open ends.

PVC balcony strip can facilitate a closed construction on the flooring if required.

HANDRAIL 50mm outside diameter aluminium alloy (powder coated).

STANCHIONS 50mm outside diameter tube in aluminium alloy (powder coated) or stainless steel.

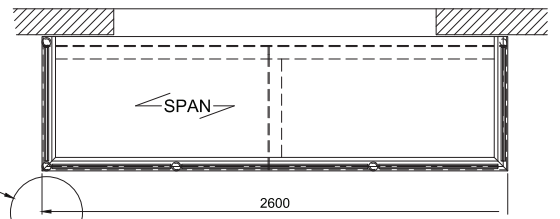
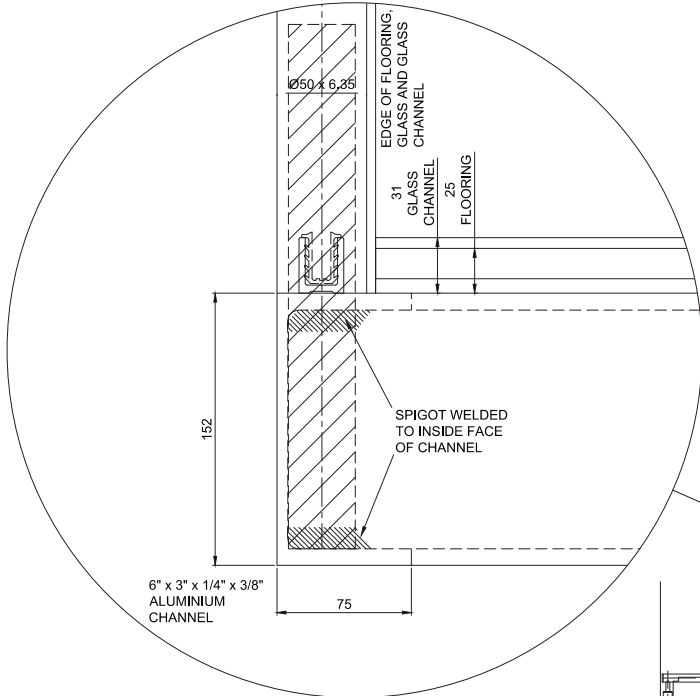

MODULAR ELAN BALCONY TYPICAL EXAMPLE

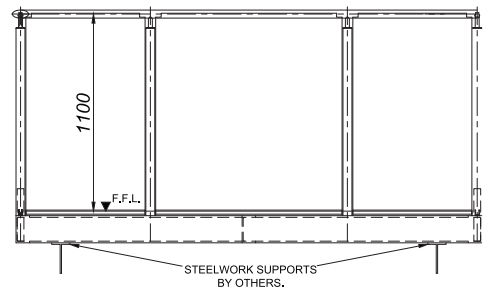
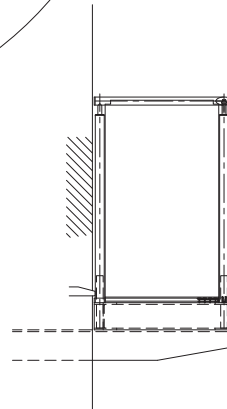

MODULAR BALCONY TYPICAL EXAMPLE

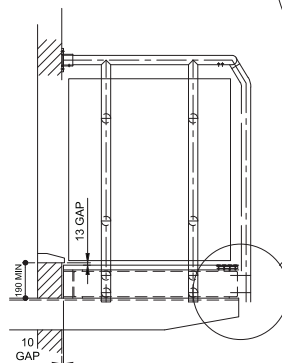
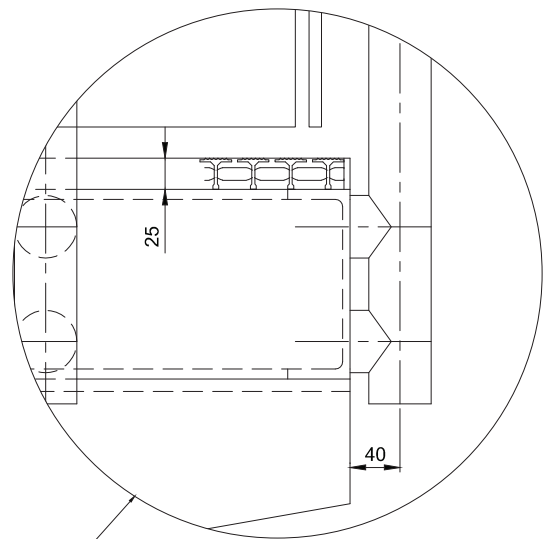
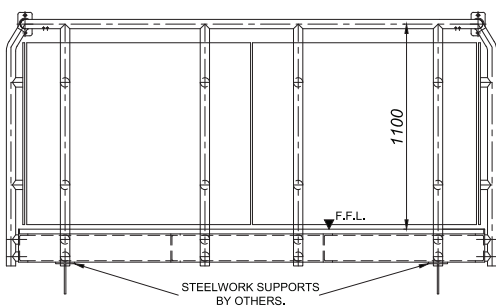
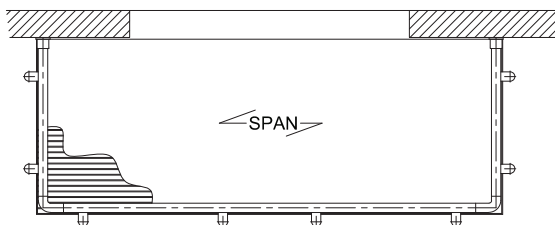

Additional guidance

Handrails and temperature to the touch

Cold conditions can cause external metal handrails to become extremely cold and uncomfortable to the touch. As a result it is possible that people will be reluctant to use a handrail, or let go of a handrail in response to discomfort. This poses a safety hazard. In the 2009 edition of BS 8300 a note added to clause 5.10.5 refers to this context in relation to the recommendation that handrails should not be 'cold or hot to touch'. To protect against the problems caused by extremely cold temperatures, handrails can be manufactured with a coating to provide low thermal conductivity, such as powder coating.

Visual contrast & Light Reflectance Values

Light Reflectance Value (LRV) is a key determining factor in the eye's perception of visual contrast between two surfaces. LRV is the amount of light reflected from a surface - theoretically the value can range from 0 (jet black) to 100 (perfect white) though in practice these two values are never achieved. A greater difference between the LRV of two surfaces results in a greater visual contrast.

Approved Document M (2004) strictly defined a 30-point difference in LRV as a reliable indicator of adequate visual contrast. However, the 2009 amendment to BS 8300 acknowledges that other factors can affect visual perception: for example, the relative area of surfaces, any curvatures and textured, metallic or glossy finishes. The difference in LRV is more important when applied in relation to small and large surfaces, e.g. a handrail and a wall. An LRV difference of 30 or more is an acceptable visual contrast according to the latest guidance.

BS6180:2011 Code of practice: barriers in and about buildings.

Characteristic horizontal design loads on balustrades

Local conditions	Uniformly distributed horizontal line load (kN/m)	Uniformly distributed load on the infill (kN/m)	Point load on the infill (kN/m)
Areas where people congregate without overcrowding e.g. stairs, corridors, landings, balconies, roof edges.	0.74	1	0.5
Restaurants and bars, retail and public areas not subject to overcrowding and pedestrian areas in car parks.	1.5	1.5	1.5
Areas subject to overcrowding e.g. retail areas, theatres, cinemas, bars, auditoria, night clubs and assembly areas.	3	1.5	1.5

NB: The horizontal uniformly distributed line load should be assumed to act at a height of 1100mm above the floor or pitch line, irrespective of the height of the actual barrier. The three load types are not additive, but need to be treated as three separate load cases.



Elan semi-structural glass
at York High School.



Registered Office:

Norton Grove Industrial Estate, Norton, Malton, Yorkshire YO17 9HQ England

T 01653 695721 **F** 01653 600418 **E** sales@neaco.co.uk

www.neaco.co.uk

Registered England 1065772. VAT NO. 168 2239 51.