

Uniclass
L5:P7113

CI/SfB

(4-)

Hn7

Swish[®]
BUILDING PRODUCTS

Installer's Handbook

Pocket Guide to
Roofline & Cladding
Installation



BS 7619

Licence No. KM33730



FM 09180

The Specifier's Choice for
Cellular PVC Roofline & Cladding

Access Systems

SAFETY FIRST!

Never attempt to access the work area with an unsupported ladder or without a stable deck. Always use a full scaffold platform or a purpose made cantilevered deck system with guard rails in place.

Health and Safety

Full health and Safety information is available on request.

Asbestos

By law all asbestos materials must be removed by trained operatives under strictly controlled conditions. If you suspect that asbestos is present you should consult your Local Authority.

Storage & Handling

Load and unload by hand and support both ends of a 5m length when handling. Stack no higher than 1m, in packing sleeve on a flat base. Avoid contact with solvents, paint, creosote, bitumen etc.

Cutting/Shaping

Use conventional carpentry tools including fine toothed saws. Power tools may be run at speeds appropriate for timber. Nail and screw holes do not require pre-drilling.

Off-Cuts

Contractors for new build and refurbishment works should be aware that larger off-cuts from some boards may have been scheduled for use in other areas of the installation and should be handled carefully until their use is established.

Fascia Boards

Swish Jumbo boards and foiled boards are able to support the weight of the lower row of tiles without the need for a tilt fillet or kick plate.

Fixings

Swish A4 grade stainless steel plastic headed nails or capped screws.

Board	Fixing	Code	Size	Qty	Max Centres
Roofline					
Jumbo	All	Nail	C083	65mm	2
	25mm	Screw	C073	65mm	2
	20mm	Screw	C072	50mm	2
Cappair & Cappit	Nail	C082	50mm	2	White 600mm
	Screw	C071	40mm	2	Foiled 400mm
Polo & Gee Pee	Nail	C081	40mm	2	
	Screw	C071	40mm	2	

Cladding

White*	Nail	C204	33mm	1	600mm to 2 storeys 400mm 3 to 2 storeys
Foiled*	Nail	C204	33mm	1	400mm

* Ensure plank ends are always nailed

Expansion Gaps

Always leave a minimum 4mm expansion gap at the end of each board, ie where two boards meet leave 8mm overall.

Sealants

Use Swish low modulus silicone. Use a primer when bonding to GRP, stainless steel, aluminium or untreated wood. Do not use with polycarbonate sheet.

Ventilation

IMPORTANT - Roof voids must be ventilated in order to stop warm air condensing on cold surfaces. Condensation encourages rot and mould growth.

Ventilation Options

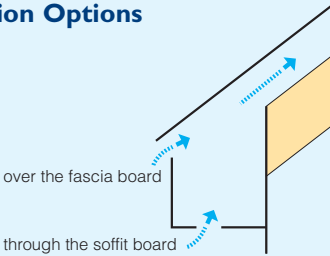

These diagrams show the minimum air path dimensions required under the current Building Regulations

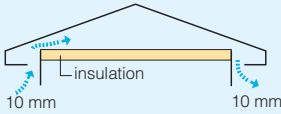

Duo pitch roof greater than 15° pitch but less than 70° with insulation at ceiling level

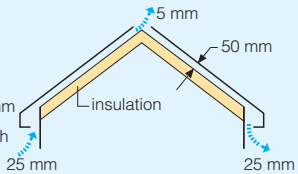

Duo pitch roof greater than 15° pitch with ceiling following the plane of the roof

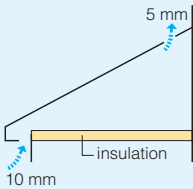

Mono pitch roof greater than 15° pitch but less than 70° with insulation at ceiling level

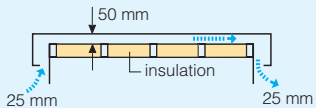

Flat roof (less than 15° pitch) with insulation at ceiling level

Compliance with these ventilation standards is required on all buildings, except those that were constructed without ventilation provision or predate the Buildings Regulations. However Swish recommends that adequate ventilation is provided on all refurbishment projects regardless of age.

For further information on UK Building Regulations please contact the Swish Technical Department on 01827 317200

Roofline Range Fascia Boards



Square Jumbo™



Ogee Jumbo™



Bullnose Jumbo™



Foiled Square

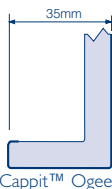

Cappit™ Ogee



Cappit™

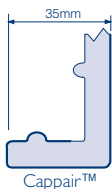

Cappair™

Soffit Boards



Gee Pee™



Fluted



TeeGee™ Cladding



Polo™ (10mm air path)



Polo™ (25mm air path)



TeeGee Polo™

Open V Polo™
also available

Strip Ventilators (air path)



Angle Ventilator
(10 & 25mm)



Soffit/Wall
(10mm)



Soffit/Soffit
(10 & 25mm)

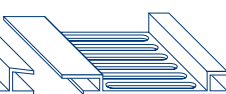

Fascia/Soffit
(25mm)

Over Fascia Protection and Ventilation

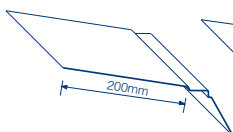

Jumbotec™

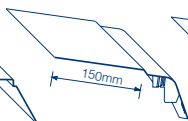

Jumbovent™
(10mm)

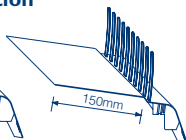

Jumbovent™
Combed
(10mm)

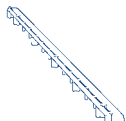

Over Fascia
Ventilator
(10mm)

General Purpose Trims



Felt Roof
Edge Trim



Plank Top
Trim



Joint Trim

Soffit to Wall Trim



Channel



External Angle
(25 & 50mm)

Decorative Roofline

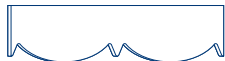

Decorative Roofline Convex (16mm thick)



Decorative Roofline Concave (16mm thick)



Roofstyle Convex 450mm



Roofstyle Concave 450mm

Also available as 350mm Straight Unit

Decorative Elements



Apex



Spire Flat back



Spire 3D



Spire Flat back

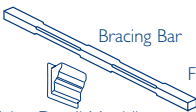

Bracing Bar



Ball Finial



Dentil Moulding

Corners & Joints



External Corner



Internal Corner



Joint



Joint



Square External Corner



Face Fix Corner



Face Fix Joint



Internal Joint 135°



External Joint 135°

Cladding Range



Shiplap



Open V

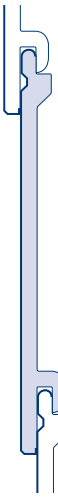

Feather Edge



Tee Gee™



Universal Starter Trim



Drip Starter Trim



Wall Starter Trim



Drip Trim



Angle Trim



Universal Channel



Butt Joint Cover



External Corner



Universal Channel with Batten Cover



Centre Joint Trim



Two Part Joint Trim



Two Part Corner Trim



Universal Two Part Trim

Roofline Installation

Preparation Checklist

- Use safe access equipment (p2).
- Inspect for asbestos (p2).
- Push back lower rows of tiles.
- Remove enough gutter, fascia, and soffit for one day's work only.
- Inspect rafters/laths and replace rotted timbers.
- Ensure fixing points available at maximum centres: white 600mm, foiled 400mm.
- Check proposed ventilation system (p3).

Sequence of Work

- A.** Cut back rotted felt to a clean edge.
- B.** Fit suitable timber hangers (preservative treated) to support soffit boards. Screw to rafter sides checking for level. Deep soffits must be nailed up every 200mm max across their depth. Set up support at hipped corners.
- C.** Set up string lines to check vertical/horizontal faces of rafter feet and hangers for straight and level.
- D.** Nail soffit board to hanger. Inner edge of soffit abuts to wall or sits on bricks. Outer edge of soffit should over hang by 10mm to fit groove in back of fascia board.
- E.** Nail fascia board to rafter feet with sufficient height to create tile kick. Allow for height of over fascia ventilator if required.
- F.** Make soffit and fascia joints between rafters.
- G.** Eaves ventilation trays maybe required to ensure air flow past roof insulation material.
- H.** Underdress existing felt with dpc material or Jumbotec. New material must dress into the gutter.
- I.** Fit gutter brackets directly to replacement fascias of 16mm and above, in accordance with manufacturer's recommendations. Ensure correct gradient (fall) in the gutter to the down pipe.
- J.** Box end construction. See p8

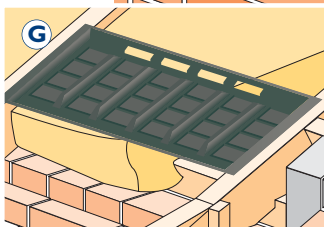
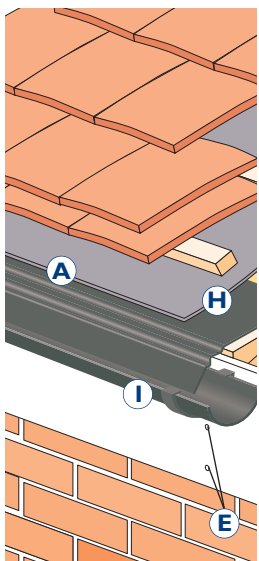

Notes for Over – Capping

1. The expansion gaps and fixing centres detailed on page 2-3 apply
2. All over-capped timber must be sound.
3. The existing timber fascia must support the weight of tiles at the eaves.

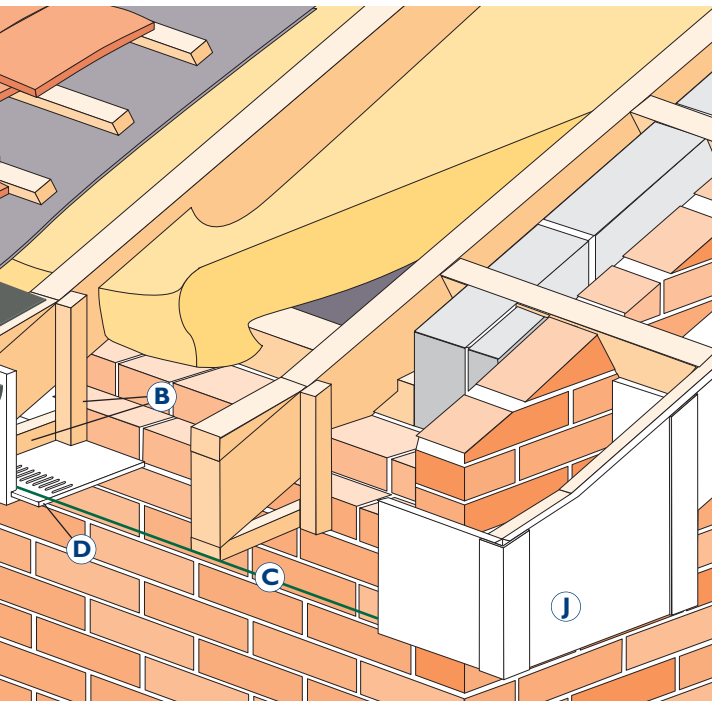

F Joints

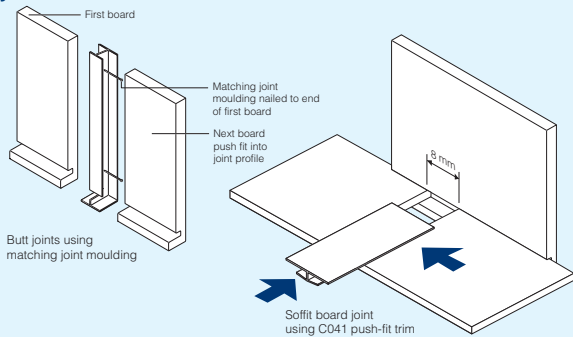

B Support blocks at hipped corners

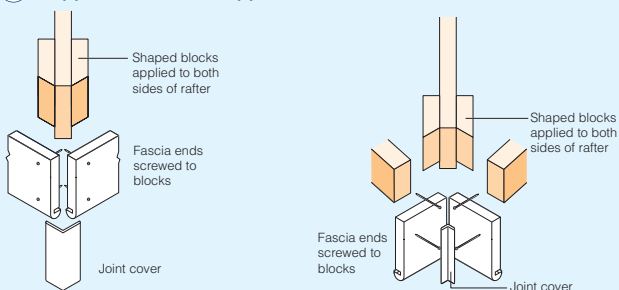

Box End Construction

- A.** Finish fascia level with the face of the rafter gable. Soffit should over hang by 10mm and may be cut square or mitred.

Note: Timber hangers should be installed as required to locate box end structure.

- B.** Measure and cut box end from a deep board. Front edge should tilt up to match height of fascia board.
- C.** Measure and cut fascia to form the return to gable wall.
- D.** Remove section from corner joint to fit around rafter.
- E.** Fix bargeboard directly to gable rafter.

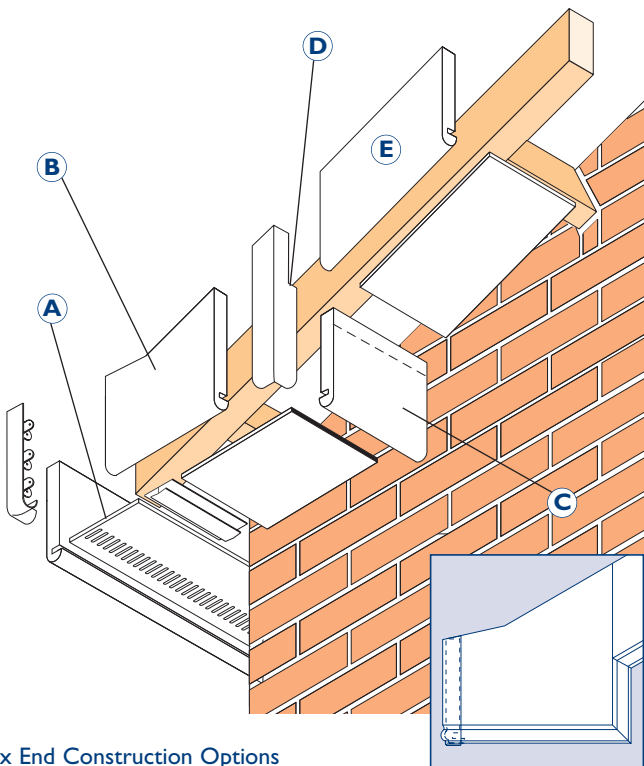

Box End Construction Options

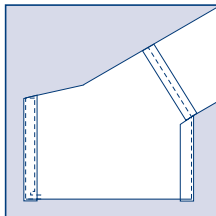
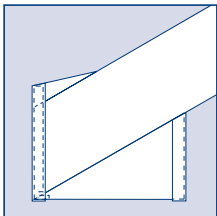
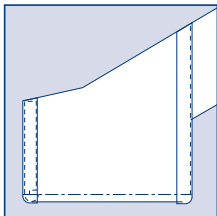

Gable/In-line Gable Construction

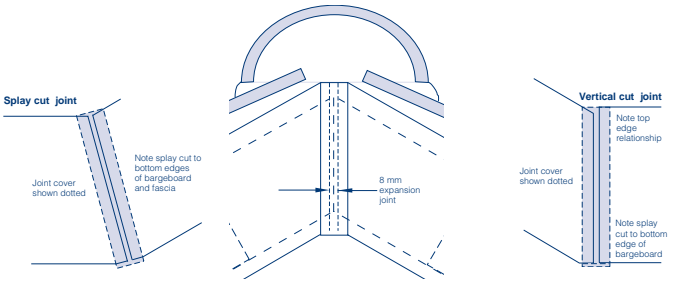

Bargeboard/Gable detail with vertical and splay cut joint options.

Decorative Roofline

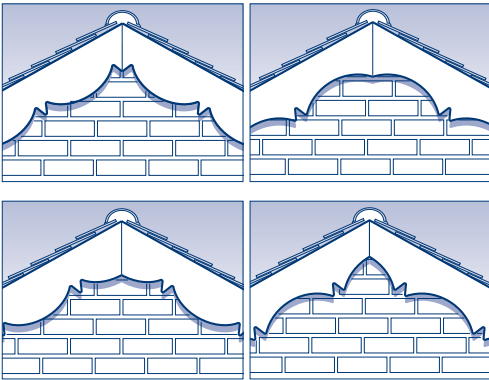

The decorative edge of the concave and convex boards allows flexibility of design at the apex.

Note the chamfered edge of the board faces to the rear.

Fascia for Flat Roofs

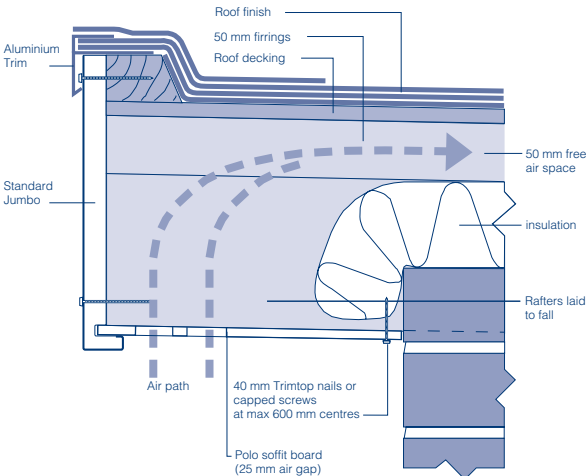

Cladding Installation

Sequence of Work

- A.** Perimeter frame battens (recommended 25 x 38mm)
- B.** Battens around openings
- C.** Intermediate vertical battens
- D.** Starter trims (or bottom angle ventilation strip, as appropriate, see inset illustrations)
- E.** Vertical perimeter trims, corner trims (where two-part trims are used, fix only the inner part)
- F.** Top perimeter trims (These engage inside the vertical trims)
- G.** Packings to battens as required for any cut planks
- H.** Plank profiles and joint covers or centre joint trims as appropriate (see p 7).
- I.** Outer components of two-part trims.

Note:

For maximum fixing centres see p 2

D Starter Trims

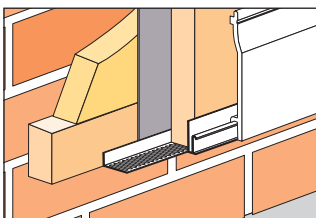
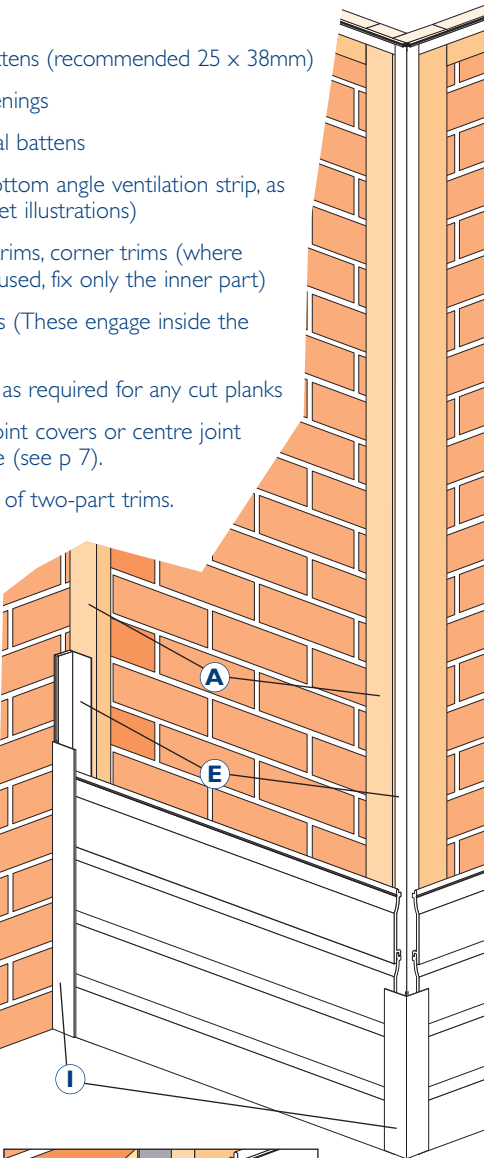
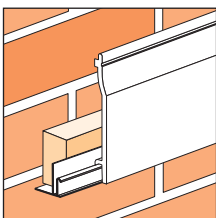
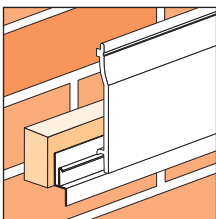
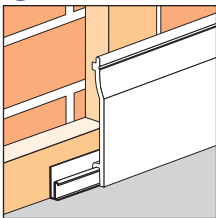

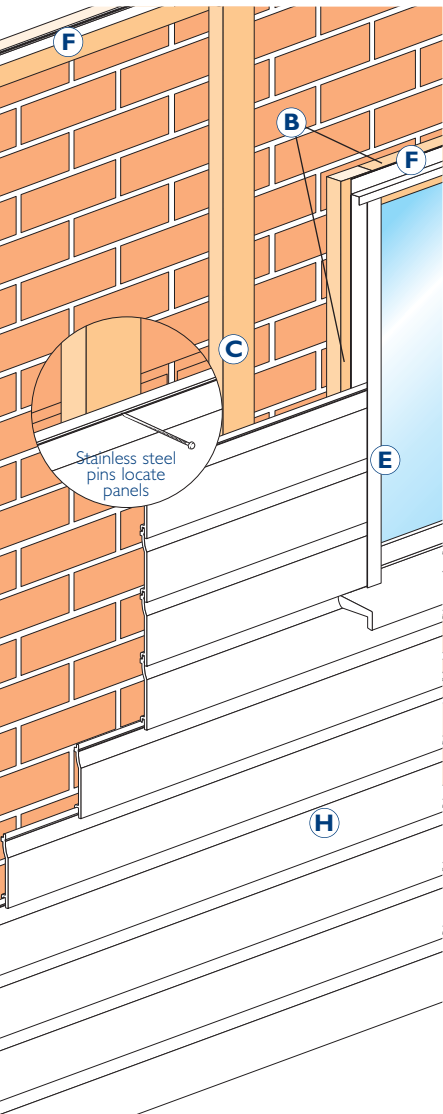

E Trim Options

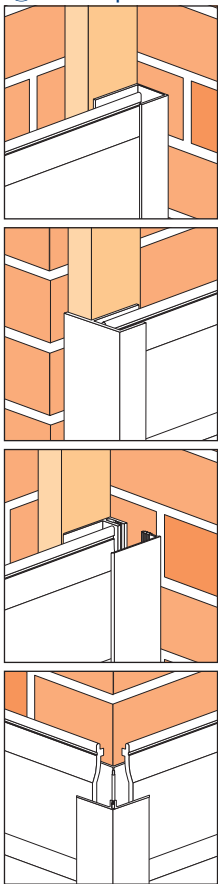

H Joint Options

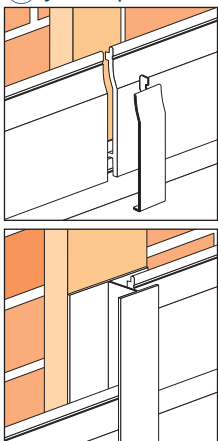

G Packing for Cut Planks

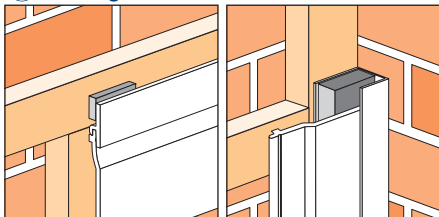

This installation guide is intended to provide a basic outline of the methods employed in installing Swish PVC Roofline and Cladding Products. For a comprehensive guide please consult the Swish Design & Specification Guides :

Roofline A227
Claddings A226

For further details contact:

Swish[®]
BUILDING PRODUCTS

SBP Limited, Pioneer House
Lichfield Road Ind. Estate, Tamworth, Staffordshire B79 7TF

Tel: (01827) 317200 Fax: (01827) 317201
e-mail: information@swishbp.co.uk
www.swishbp.co.uk

© SBP Limited 07 / 04
Swish, Tee Gee, Polo, Jumbo and Jumbotec
are all registered trademarks

A430