

# BOLLARDS & BARRIERS





## **We are far from just a street furniture supplier**

As designers, manufacturers and installers of street furniture, canopies and shelters, we pride ourselves on being the go-to experts that can offer you more.

We are determined to ensure that your outdoor space is vibrant, practical, aesthetically pleasing and functional, whilst offering you cost-effective solutions to your outdoor space planning.

As a company, we like to change the way people interact with the outdoor space, and how they view the landscape too.

We are determined to help organisations create outdoor environments that people enjoy walking through, interacting with or simply using it as a stopping and gathering point.

Our resources, flexibility and expertise often enables us to deliver more performance than your budget specifies and we will always go that extra mile for our clients when it comes to providing excellent customer service.

We are proud to have had over three decades of experience and expertise in our sector, allowing us to assist your organisation in choosing the right products for your individual scheme.

## **We are Bailey Streetscene**





## Large Recess Stainless Steel Bollard

This stylish root fixed bollard comes with a brushed satin finish, a 75mm recess, semi dome top. With a main body grade 304 stainless steel, or in grade 316 for more aggressive environments such as industrial or coastal areas, this is a popular member of the Bailey Streetscene catalogue of products.

It also comes with other options, such as being surface mounted, having a bright polish finish, with reflective tape added, or availability in other sizes -including bespoke ones.

H: 1200mm x Dia: 101mm

**TECHNICAL  
DRAWINGS  
AVAILABLE ON  
REQUEST**

**PLEASE CONTACT  
OUR SALES TEAM**

## Materials, Finishes & Options

### Stainless steel

Available in the options below;  
for further details on our **stainless steel**  
visit our **materiality page >>**

#### Standard



Brushed  
satin

#### Premium



Bright  
polish



Bead  
blasted



Mirror  
Polished

### Fixtures

This product can be customised with a range of optional  
fixtures. If you have any further bespoke requirements  
**get in touch**, our sales team will be happy to help.

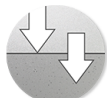

Surface Mount  
/ Root fixed



Grooves



Bespoke top



Removable



## Double Recess Stainless Steel Bollard

Coming in a brushed satin or bright polish finish, with two 27mm wide recesses, this is a contemporary and striking looking bollard that is fit for a number of purposes. The Double Recess Stainless Steel Bollard comes with a main body of grade 304 stainless steel, with an option of grade 316 for more aggressive environments such as industrial or coastal areas.

It has a semi dome top, and comes as root fixed, but a surface mounted version is available, as are two reflective hazard bands.

H: 1200mm x Dia: 101mm

TECHNICAL  
 DRAWINGS  
 AVAILABLE ON  
 REQUEST

PLEASE CONTACT  
 OUR SALES TEAM

## Materials, Finishes & Options

**Stainless steel**  
 Available in the options below;  
 for further details on our **stainless steel**  
 visit our **materiality page >>**

**Fixtures**  
 This product can be customised with a range of optional  
 fixtures. If you have any further bespoke requirements  
**get in touch**, our sales team will be happy to help.

Standard

Premium



Brushed  
satin



Bright  
polish



Bead  
blasted



Mirror  
Polished

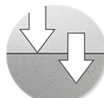

Surface Mount  
/ Root fixed



Grooves



Bespoke top



Removable





## Mitred Top Stainless Steel Bollard

This is a stainless steel bollard offering a clean and contemporary look that adds style to any landscape. The Mitred Top Stainless Steel Bollard comes with a main body of grade 304 stainless steel, with the option of grade 316 for more aggressive environments such as industrial or coastal areas.

With a brushed satin finish complete with a mitred top, this comes as root fixed, but with the possibility of being surface mounted if you so wish. Flexibility comes through this bollard being available in other sizes.

H: 1200mm x Dia: 101mm

**TECHNICAL  
DRAWINGS  
AVAILABLE ON  
REQUEST**

**PLEASE CONTACT  
OUR SALES TEAM**

## Materials, Finishes & Options

**Stainless steel**  
 Available in the options below;  
 for further details on our **stainless steel**  
 visit our **materiality page >>**

**Fixtures**  
 This product can be customised with a range of optional  
 fixtures. If you have any further bespoke requirements  
**get in touch**, our sales team will be happy to help.

Standard

Premium



Brushed  
satin



Bright  
polish

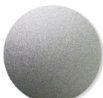

Bead  
blasted



Mirror  
Polished

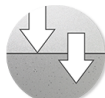

Surface Mount  
/ Root fixed



Grooves



Bespoke top



Removable



## Brushed Satin Bands Stainless Steel Bollard

Another from the extensive range of Bailey Streetscene products that are superb for ensuring that the edge of a structure, car park or space is easily and properly identified, or for separating areas.

With a main body grade 304 stainless steel, or in grade 316 for more aggressive environments such as industrial or coastal areas, this flat top, root fixed bollard comes in a bright polished finish with two brush satin bands. A surface mounted version is also available should you require it. A contemporary-looking bollard that will look great in many different outdoor spaces.

H: 1200mm x Dia: 101mm

**TECHNICAL  
DRAWINGS  
AVAILABLE ON  
REQUEST**

**PLEASE CONTACT  
OUR SALES TEAM**

## Materials, Finishes & Options

**Stainless steel**  
Available in the options below;  
for further details on our **stainless steel**  
visit our **materiality page >>**

**Fixtures**  
This product can be customised with a range of optional  
fixtures. If you have any further bespoke requirements  
**get in touch**, our sales team will be happy to help.

Standard

Premium



Brushed  
satin



Bright  
polish



Bead  
blasted



Mirror  
Polished

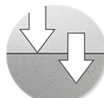

Surface Mount  
/ Root fixed



Grooves



Bespoke top



Removable





## Bead Blast Bands Stainless Steel Bollard

Another from the extensive range of Bailey Streetscene products that are superb for ensuring that the edge of a structure, car park or space is easily and properly identified, or for separating areas.

With a main body grade 304 stainless steel, or in grade 316 for more aggressive environments such as industrial or coastal areas, this flat top, root fixed bollard comes in a bright polished finish with two bead blast bands. A surface mounted version is also available should you require it.

H: 1200mm x Dia: 101mm

**TECHNICAL  
DRAWINGS  
AVAILABLE ON  
REQUEST**

**PLEASE CONTACT  
OUR SALES TEAM**

## Materials, Finishes & Options

**Stainless steel**  
Available in the options below;  
for further details on our **stainless steel**  
visit our **materiality page >>**

Standard

Premium



Brushed  
satin



Bright  
polish



Bead  
blasted



Mirror  
Polished

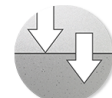

Surface Mount  
/ Root fixed



Grooves



Bespoke top



Removable

**Fixtures**  
This product can be customised with a range of optional  
fixtures. If you have any further bespoke requirements  
**get in touch**, our sales team will be happy to help.





## Bead Blasted Stainless Steel Bollard

Another from the extensive range of Bailey Streetscene products that are superb for ensuring that the edge of a structure, car park or space is easily and properly identified, or for separating areas.

With a main body grade 304 stainless steel, or in grade 316 for more aggressive environments such as industrial or coastal areas, this comes with a bead blast finish, with a brushed satin or bright polished semi dome top, and is root fixed. A surface mounted version is also available should you require it.

H: 1200mm x Dia: 101mm

**TECHNICAL  
DRAWINGS  
AVAILABLE ON  
REQUEST**

**PLEASE CONTACT  
OUR SALES TEAM**

## Materials, Finishes & Options

### Stainless steel

Available in the options below; for further details on our **stainless steel** visit our **materiality page >>**

#### Standard

#### Premium



Brushed satin



Bright polish

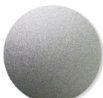

Bead blasted



Mirror Polished

### Fixtures

This product can be customised with a range of optional fixtures. If you have any further bespoke requirements **get in touch**, our sales team will be happy to help.

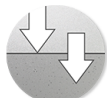

Surface Mount / Root fixed



Grooves



Bespoke top



Removable

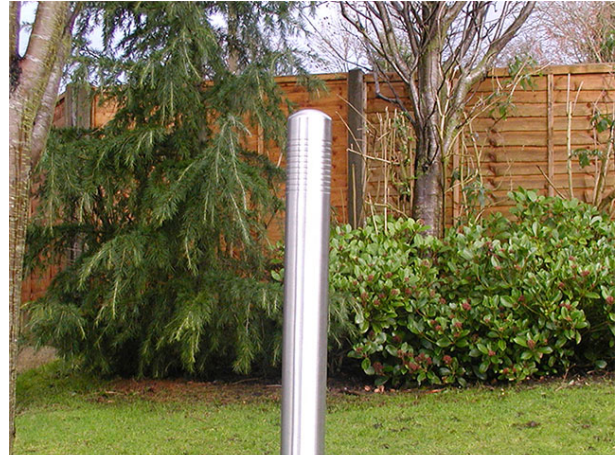

## Multi Groove Stainless Steel Bollard

Root fixed, the Multi Groove Stainless Steel Bollard is a durable, hard-wearing bollard that is well suited to a range of applications such as pedestrian walkways and protected parking areas. Its main body is grade 304 stainless steel, but you also have the option of 316 stainless steel for more aggressive environments such as industrial or coastal areas.

It comes in a brushed satin finish with a dome top, with the options of a bright polish finish, and a surface mounted version is available.

H: 1200mm x Dia: 101mm

**TECHNICAL  
DRAWINGS  
AVAILABLE ON  
REQUEST**

**PLEASE CONTACT  
OUR SALES TEAM**

## Materials, Finishes & Options

**Stainless steel**  
Available in the options below;  
for further details on our **stainless steel**  
visit our **materiality page >>**

**Fixtures**  
This product can be customised with a range of optional  
fixtures. If you have any further bespoke requirements  
**get in touch**, our sales team will be happy to help.

Standard

Premium



Brushed  
satin



Bright  
polish



Bead  
blasted



Mirror  
Polished

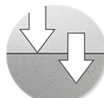

Surface Mount  
/ Root fixed



Grooves



Bespoke top



Removable





## Single Groove Stainless Steel Bollard

The great thing about this choice of bollard is that you can order it to your requirements. Other sizes are readily available, including bespoke sizes, and that's not where the options end....

With a main body of grade 304 stainless steel, this is also available in grade 316 stainless steel for more aggressive environments such as industrial or coastal areas. It comes with a brushed satin finish with a 25mm recessed groove, semi dome top, and comes root fixed. It also come with the option of being surface mounted, with a bright polish finish, or including a 25mm band of reflective tape.

H: 1200mm x Dia: 101mm

TECHNICAL  
 DRAWINGS  
 AVAILABLE ON  
 REQUEST

PLEASE CONTACT  
 OUR SALES TEAM

## Materials, Finishes & Options

**Stainless steel**  
 Available in the options below;  
 for further details on our **stainless steel**  
 visit our **materiality page >>**

**Fixtures**  
 This product can be customised with a range of optional  
 fixtures. If you have any further bespoke requirements  
**get in touch**, our sales team will be happy to help.

Standard

Premium



Brushed  
satin



Bright  
polish



Bead  
blasted



Mirror  
Polished

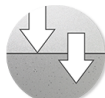

Surface Mount  
/ Root fixed



Grooves



Bespoke top



Removable



## Removable Stainless Steel Bollard

This bollard stands 900mm above ground, and its main body is manufactured from grade 304 or 316 stainless steel for more aggressive environments such as industrial or coastal areas. It has a brushed satin finish, with the possibility of a bright polish finish, has a semi dome top, and is root fixed.

It's a smart, contemporary option for ensuring that the edge of a structure, car park, or space is easily and properly identified, or for separating areas.

H : 900mm x Dia : 101mm

**TECHNICAL  
 DRAWINGS  
 AVAILABLE ON  
 REQUEST**

**PLEASE CONTACT  
 OUR SALES TEAM**

## Materials, Finishes & Options

**Stainless steel**  
 Available in the options below;  
 for further details on our **stainless steel**  
 visit our **materiality page >>**

**Fixtures**  
 This product can be customised with a range of optional  
 fixtures. If you have any further bespoke requirements  
**get in touch**, our sales team will be happy to help.

Standard

Premium



Brushed  
satin



Bright  
polish



Bead  
blasted



Mirror  
Polished



Grooves



Banding



Handles



Padlocks  
Supplied





## Record Groove Stainless Steel Bollard

The great thing about this choice of bollard is that you can order it to your requirements. Other sizes are readily available, including bespoke sizes, and that's not where the options end....

With a main body of grade 304 stainless steel, the Record Groove Stainless Steel Bollard is also available in grade 316 stainless steel for more aggressive environments such as industrial or coastal areas. It comes with a brushed satin finish with a 50mm wide, record type groove, flat top, and comes root fixed. It also come with the option of being surface mounted, with a bright polish finish, or including reflective tape.

H: 1200mm x Dia: 101mm

TECHNICAL  
 DRAWINGS  
 AVAILABLE ON  
 REQUEST

PLEASE CONTACT  
 OUR SALES TEAM

## Materials, Finishes & Options

**Stainless steel**  
 Available in the options below;  
 for further details on our **stainless steel**  
 visit our **materiality page >>**

**Fixtures**  
 This product can be customised with a range of optional  
 fixtures. If you have any further bespoke requirements  
**get in touch**, our sales team will be happy to help.

Standard

Premium



Brushed  
satin



Bright  
polish

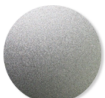

Bead  
blasted



Mirror  
Polished

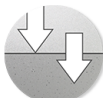

Surface Mount  
/ Root fixed



Grooves



Bespoke top



Removable





## Feature Top Stainless Steel Bollard

Main body grade 304 or 316 stainless steel for more aggressive environments, such as industrial or coastal areas, the Feature Top Stainless Steel Bollard is a great choice for anyone looking for a hard-wearing, contemporary looking bollard.

With a brushed satin finish with a deep groove and semi-dome feature top, this is a root fixed bollard but comes with the option of being surface mounted. It gives a clean look to any outdoor landscape, and it's suited to a range of applications such as pedestrian walkways and protected parking areas.

H: 1200mm x Dia: 101mm

**TECHNICAL  
 DRAWINGS  
 AVAILABLE ON  
 REQUEST**

**PLEASE CONTACT  
 OUR SALES TEAM**

## Materials, Finishes & Options

**Stainless steel**  
 Available in the options below;  
 for further details on our **stainless steel**  
 visit our **materiality page >>**

**Fixtures**  
 This product can be customised with a range of optional  
 fixtures. If you have any further bespoke requirements  
**get in touch**, our sales team will be happy to help.

Standard

Premium



Brushed  
satin



Bright  
polish

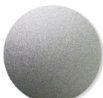

Bead  
blasted



Mirror  
Polished

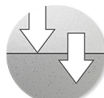

Surface Mount  
/ Root fixed



Grooves



Bespoke top



Removable



## Surface Mounted Stainless Steel Bollard

Available in a range of sizes, including ones bespoke to you, the Surface Mounted Stainless Steel Bollard comes in main body grade 304, or 316 stainless steel for more aggressive environments such as industrial or coastal areas. It has a brushed satin finish, and has a semi dome top, that makes it a clean, sharp bollard option for any number of outdoor environments.

Other sizes available including bespoke sizes. Root fixed version. Bright polish finish. 180mm diameter base plate for surface fixing.

H: 900mm x Dia: 101mm

TECHNICAL  
 DRAWINGS  
 AVAILABLE ON  
 REQUEST

PLEASE CONTACT  
 OUR SALES TEAM

## Materials, Finishes & Options

**Stainless steel**  
 Available in the options below;  
 for further details on our **stainless steel**  
 visit our **materiality page >>**

**Fixtures**  
 This product can be customised with a range of optional  
 fixtures. If you have any further bespoke requirements  
**get in touch**, our sales team will be happy to help.

Standard

Premium



Brushed  
satin



Bright  
polish



Bead  
blasted



Mirror  
Polished

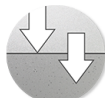

Surface Mount  
/ Root fixed



Grooves



Bespoke top



Removable





## Full Dome Stainless Steel Bollard

Offering a clean and contemporary look to your outdoor space, the Full Dome Stainless Steel Bollard is manufactured to main body grade 304 or 316 stainless steel for more aggressive environments such as industrial or coastal areas. It comes in a brushed satin or bright polish finish with a 50mm recess and a fully domed top.

Root fixed, a surface mounted version is also available, as is reflective tape. It's an excellent, sturdy bollard that is well suited to a range of applications such as pedestrian walkways and protected parking areas.

H: 1200mm x Dia: 101mm

TECHNICAL  
 DRAWINGS  
 AVAILABLE ON  
 REQUEST

PLEASE CONTACT  
 OUR SALES TEAM

## Materials, Finishes & Options

**Stainless steel**  
 Available in the options below;  
 for further details on our **stainless steel**  
 visit our **materiality page >>**

**Fixtures**  
 This product can be customised with a range of optional  
 fixtures. If you have any further bespoke requirements  
**get in touch**, our sales team will be happy to help.

Standard

Premium



Brushed  
satin



Bright  
polish

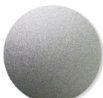

Bead  
blasted



Mirror  
Polished

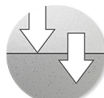

Surface Mount  
/ Root fixed



Grooves



Bespoke top



Removable



## Anti Ram Semi Dome Top Stainless Steel Bollard

The Anti-Ram Semi Dome Top Stainless Steel Bollard consists of our standard stainless steel bollard with a 101 diameter galvanised mild steel inner reinforcement tube securely fastened within to give additional anti-ram benefits. The main body is manufactured from grade 304 or grade 316 stainless steel for more aggressive environments such as industrial or coastal areas.

This bollard has a brush satin finish and comes root fixed as standard, with either a semi dome top or a welded flat top.

H: 1200mm x Dia: 114mm

TECHNICAL  
 DRAWINGS  
 AVAILABLE ON  
 REQUEST

PLEASE CONTACT  
 OUR SALES TEAM

## Materials, Finishes & Options

**Stainless steel**  
 Available in the options below;  
 for further details on our **stainless steel**  
 visit our **materiality page >>**

**Fixtures**  
 This product can be customised with a range of optional  
 fixtures. If you have any further bespoke requirements  
**get in touch**, our sales team will be happy to help.

Standard

Premium



Brushed  
satin



Bright  
polish



Bead  
blasted



Mirror  
Polished

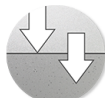

Surface Mount  
/ Root fixed



Grooves



Bespoke top



Removable





## Semi Dome Top Stainless Steel Bollard

An attractive and durable bollard, this has a main body that is manufactured from grade 304 or 316 stainless steel for more aggressive environments such as industrial or coastal areas. It has a brushed satin finish, and comes complete with a semi dome top, and is root fixed. Surface mounted version. Other sizes are available including bespoke sizes. Just tell us your requirements and we'll do the rest.

H: 1500mm x Dia: 114mm

**TECHNICAL  
 DRAWINGS  
 AVAILABLE ON  
 REQUEST**

**PLEASE CONTACT  
 OUR SALES TEAM**

## Materials, Finishes & Options

**Stainless steel**  
 Available in the options below;  
 for further details on our **stainless steel**  
 visit our **materiality page >>**

**Fixtures**  
 This product can be customised with a range of optional  
 fixtures. If you have any further bespoke requirements  
**get in touch**, our sales team will be happy to help.

Standard

Premium



Brushed  
satin



Bright  
polish

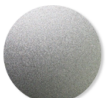

Bead  
blasted



Mirror  
Polished

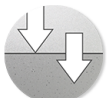

Surface Mount  
/ Root fixed



Grooves



Bespoke top



Removable





## Stainless Steel Bollard with Sep Cap

With a main body grade 304, or in 316 stainless steel for more aggressive environments such as industrial or coastal areas, this is an excellent choice for anyone looking to offer a clean and contemporary look to their outdoor space. The Stainless Steel Bollard with Sep Cap has a brushed satin finish and is root fixed, although a surface mounted version is available.

To give you flexibility of choice, there are other sizes available - including bespoke sizes to suit your exact requirements.

H: 1200mm x Dia: 101mm

TECHNICAL  
 DRAWINGS  
 AVAILABLE ON  
 REQUEST

PLEASE CONTACT  
 OUR SALES TEAM

## Materials, Finishes & Options

**Stainless steel**  
 Available in the options below;  
 for further details on our **stainless steel**  
 visit our **materiality page >>**

**Fixtures**  
 This product can be customised with a range of optional  
 fixtures. If you have any further bespoke requirements  
**get in touch**, our sales team will be happy to help.

Standard

Premium



Brushed  
satin



Bright  
polish

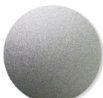

Bead  
blasted



Mirror  
Polished

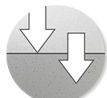

Surface Mount  
/ Root fixed



Grooves



Bespoke top



Removable



## Square Flat Top Stainless Steel Bollard

This is a popular mainstay of the Bailey Streetscene product portfolio, and has a main body made from grade 304, or 316 stainless steel for more aggressive environments such as industrial or coastal areas. Brushed satin finish with square flat top.

This is a root fixed bollard that is a smart, contemporary option for ensuring that the edge of a structure, car park, or space, is easily and properly identified, or for separating or marking different areas.

L: 101mm x D: 101mm x H: 1200mm

**TECHNICAL  
DRAWINGS  
AVAILABLE ON  
REQUEST**

**PLEASE CONTACT  
OUR SALES TEAM**

## Materials, Finishes & Options

**Stainless steel**  
Available in the options below;  
for further details on our **stainless steel**  
visit our **materiality page >>**

**Fixtures**  
This product can be customised with a range of optional  
fixtures. If you have any further bespoke requirements  
**get in touch**, our sales team will be happy to help.

Standard

Premium



Brushed  
satin



Bright  
polish



Bead  
blasted



Mirror  
Polished

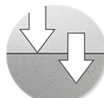

Surface Mount  
/ Root fixed



Grooves



Bespoke top



Removable





## Hossegor Bollard

The rounded Hossegor Bollard is manufactured from ductile cast iron with a primed coat and a grey forge top coat, ensuring that it's a striking-looking bollard, that comes with an anti-corrosion finish. This makes it a durable, hard-wearing bollard, superbly fit-for-purpose for any number of outdoor environments.

A popular and contemporary part of the Bailey Streetscene outdoor bollard portfolio of products.

H: 150mm x Dia: 300mm

**TECHNICAL  
DRAWINGS  
AVAILABLE ON  
REQUEST**

**PLEASE CONTACT  
OUR SALES TEAM**

## Materials, Finishes & Options

### Steel

Available in the options below;  
for further details on our **steel** visit our **materiality page >>**

#### Standard

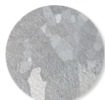

Galvanised

#### Premium



Powder coated

### Colours

Available in a huge range of **RAL** colours.

Our most popular colours are;

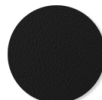

Jet black



Graphite grey



Ultramarine



White

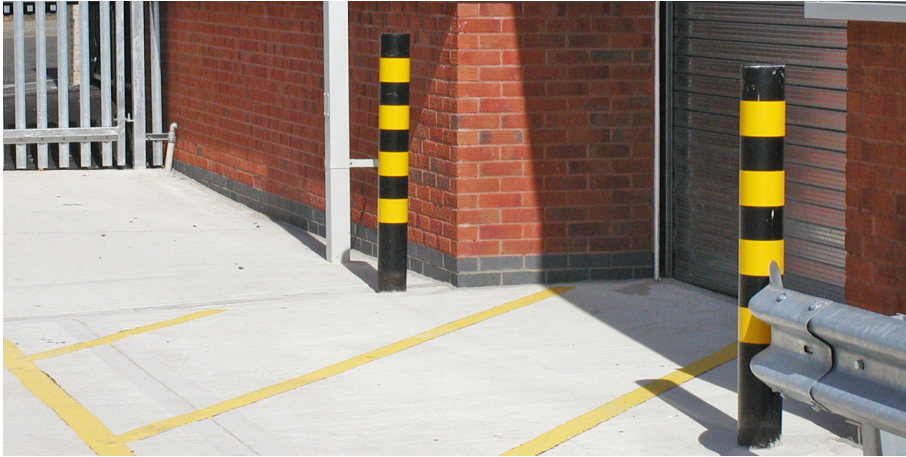

## Steel Bollard Hazard Band

Great for ensuring that the edge of a structure, car park, or space is easily and properly identified, possibly for separating areas, and also superb for restricting access and preventing unauthorised entry of vehicles - the Steel Bollard Hazard Band is a really popular Bailey Streetscene product.

These root fixed hazard band steel bollards are galvanised and powder coated in a range of colours and fitted with contrasting bands, and are available in a full range of diameters and square section steels.

Optional extras: Anti-ram addition. Removable Version. Chain lug attachments. Surface mount.

H: 1000mm x Dia: 139mm

**TECHNICAL  
DRAWINGS  
AVAILABLE ON  
REQUEST**

**PLEASE CONTACT  
OUR SALES TEAM**

## Materials, Finishes & Options

**Steel**  
Available in the options below;  
for further details on our **steel** visit our **materiality page >>**

### Colours

Available in a huge range of **RAL** colours.

Our most popular colours are;

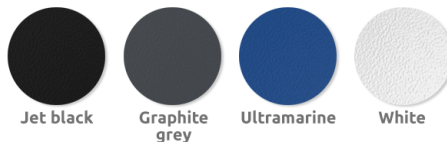
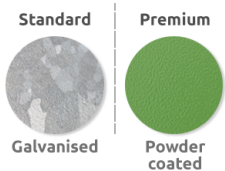

### Fixtures

This product can be customised with a range of optional fixtures. If you have any further bespoke requirements **get in touch**, our sales team will be happy to help.

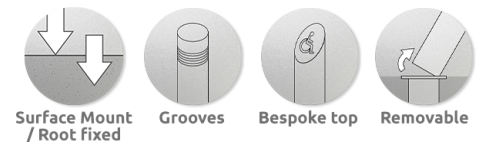





## Steel Bollard Large Single Groove

This bollard has a galvanised finish as standard and can be powder coated in a range of colours. A root fixed bollard, this comes with a number of optional extras, making this a popular and durable product. If you want a smart, contemporary looking bollard that is great for separating areas, or for ensuring that the edge of a structure, car park, or space is easily and properly identified, then this makes a great solution.

Optional extras include: Anti-ram. Removable. Chain lug attachments. Hazard Banding. Surface Mounted.

H: 1000mm x Dia: 139mm

**TECHNICAL  
DRAWINGS  
AVAILABLE ON  
REQUEST**

**PLEASE CONTACT  
OUR SALES TEAM**

## Materials, Finishes & Options

**Steel**  
 Available in the options below;  
 for further details on our **steel** visit our **materiality page >>**

### Colours

Available in a huge range of **RAL** colours.

Our most popular colours are;

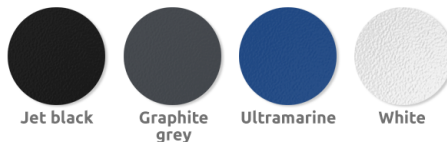
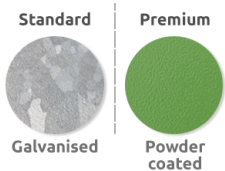

### Fixtures

This product can be customised with a range of optional fixtures. If you have any further bespoke requirements **get in touch**, our sales team will be happy to help.

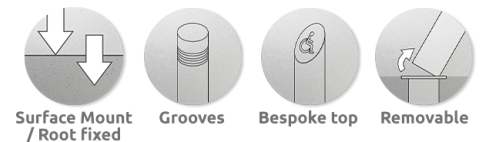





## Steel Bollard Slant Top 139mm Diameter

This is a 139mm slanted top diameter bollard, with a galvanised finish as standard and can be powder coated in a range of colours. A root fixed bollard, the 139mm Diameter Steel Slanted Top Bollard does come with a number of optional extras, making this a popular and durable product.

If you want a smart, contemporary looking bollard that is great for separating areas, or for ensuring that the edge of a structure, car park, or space is easily and properly identified, then this makes a great solution.

Optional extras include: Anti-ram. Removable. Chain lug attachments. Hazard Banding. Surface Mounted.

H: 1000mm x Dia: 139mm

**TECHNICAL  
DRAWINGS  
AVAILABLE ON  
REQUEST**

**PLEASE CONTACT  
OUR SALES TEAM**

## Materials, Finishes & Options

**Steel**  
 Available in the options below;  
 for further details on our **steel** visit our **materiality page >>**

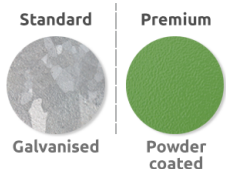

**Colours**  
 Available in a huge range of RAL colours.  
 Our most popular colours are;

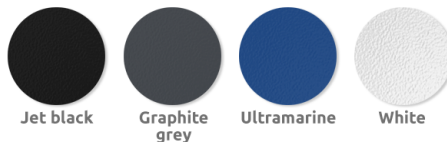

**Fixtures**  
 This product can be customised with a range of optional fixtures. If you have any further bespoke requirements **get in touch**, our sales team will be happy to help.

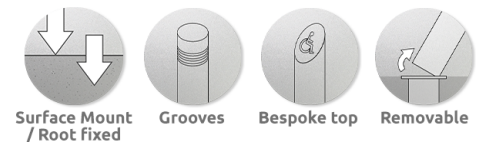



## Steel Bollard 139mm Diameter

This is a 139mm diameter bollard, with a galvanised finish as standard and can be powder coated in a range of colours. A root fixed bollard, the 139mm Diameter Steel Bollard does come with a number of optional extras, making this a popular and durable product.

If you want a smart, contemporary looking bollard that is great for separating areas, or for ensuring that the edge of a structure, car park, or space is easily and properly identified, then this makes a great solution.

Optional extras include: Anti-ram. Removable. Chain lug attachments. Hazard Banding. Surface Mounted.

H: 1000mm x Dia: 139mm

**TECHNICAL  
DRAWINGS  
AVAILABLE ON  
REQUEST**

**PLEASE CONTACT  
OUR SALES TEAM**

## Materials, Finishes & Options

### Steel

Available in the options below;  
for further details on our **steel** visit our **materiality page >>**

#### Standard



Galvanised

#### Premium



Powder coated

### Colours

Available in a huge range of **RAL** colours.

Our most popular colours are;



Jet black

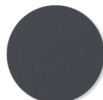

Graphite grey



Ultramarine



White

### Fixtures

This product can be customised with a range of optional fixtures. If you have any further bespoke requirements **get in touch**, our sales team will be happy to help.

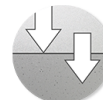

Surface Mount / Root fixed



Grooves



Bespoke top



Removable





## Steel Bollard 168mm Diameter

This is a 168mm diameter bollard, with a galvanised finish as standard and can be powder coated in a range of colours. A root fixed bollard, the 168mm Diameter Steel Bollard does come with a number of optional extras, making this a popular and durable product.

If you want a smart, contemporary looking bollard that is great for separating areas, or for ensuring that the edge of a structure, car park, or space is easily and properly identified, then this makes a great solution.

Optional extras include: Anti-ram. Removable. Chain lug attachments. Hazard Banding. Surface Mounted.

H: 1000mm x Dia: 168mm

**TECHNICAL  
DRAWINGS  
AVAILABLE ON  
REQUEST**

**PLEASE CONTACT  
OUR SALES TEAM**

## Materials, Finishes & Options

**Steel**  
 Available in the options below;  
 for further details on our **steel** visit our **materiality page >>**

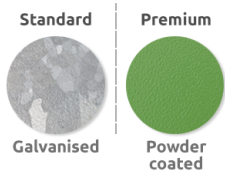

**Colours**  
 Available in a huge range of **RAL** colours.  
 Our most popular colours are;

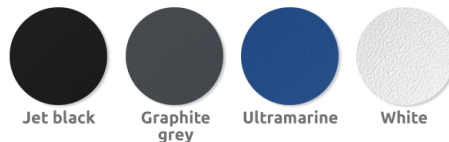

**Fixtures**  
 This product can be customised with a range of optional fixtures. If you have any further bespoke requirements **get in touch**, our sales team will be happy to help.

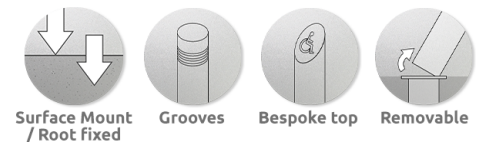



## Anti Ram Raid Post

This Anti Ram Raid Post has a hot dipped galvanised finish, widely used in protecting warehouses, shops, stores and property. The post locates into a socket embedded in concrete. The Post has been approved by Police and Local Government Authorities and recommended by insurance companies.

To raise and lower the unit, a key is used, and it is secured by a padlock (supplied at extra cost) placed inside the flanges to make it difficult for access. The Anti Ram Raid Post can be removed and replaced if needed in case of any damage or needs servicing.

H: 950mm x Weight: 35Kgs

**TECHNICAL  
 DRAWINGS  
 AVAILABLE ON  
 REQUEST**

**PLEASE CONTACT  
 OUR SALES TEAM**

## Materials, Finishes & Options

**Steel**  
 Available in the options below;  
 for further details on our **steel** visit our **materiality page >>**

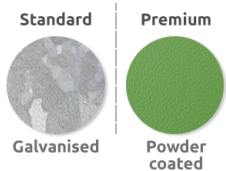

**Colours**  
 Available in a huge range of RAL colours.  
 Our most popular colours are;

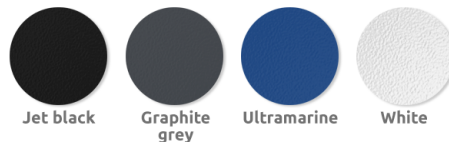

**Fixtures**  
 This product can be customised with a range of optional fixtures. If you have any further bespoke requirements **get in touch**, our sales team will be happy to help.

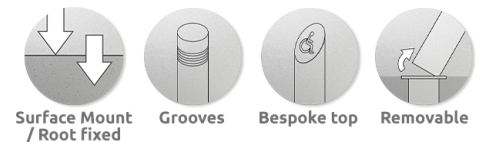





## Piramidal Bollard

Manufactured from corten steel with its timeless and distinctive rugged appearance coupled with its hard-wearing characteristics, makes the Piramidal Bollard an excellent choice for any environment. It's a smart, contemporary option for ensuring that the edge of a structure, car park, or space is easily and properly identified, or for separating areas.

L: 100mm x D: 100mm x H: 900mm

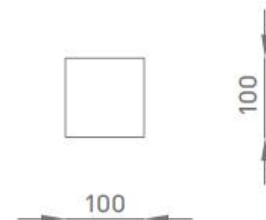
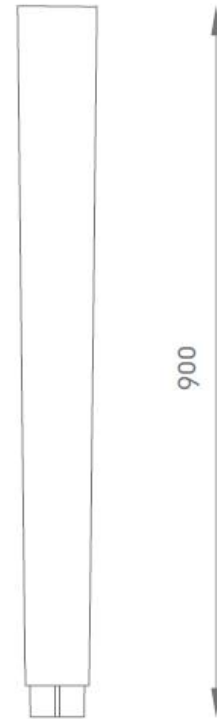

## Materials, Finishes & Options

**Steel**  
 Available in the options below;  
 for further details on our **steel** visit our **materiality page >>**

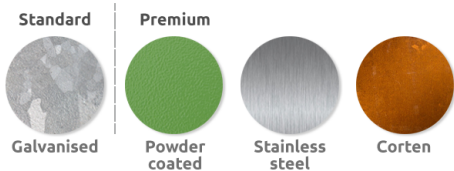

**Fixtures**  
 This product can be customised with a range of optional fixtures. If you have any further bespoke requirements **get in touch**, our sales team will be happy to help.





## Illuminated Surface Mounted Bollard

Our Illuminated Surface Mounted Bollard is designed for illuminating paths, walkways and any outdoor space. This bollard features a hot dipped galvanised steel finish with an Epoxi primer and black oxiron polyester top coat. Also available in bright polished grade 304 stainless steel. Opal or clear polycarbonate injection moulded diffusers offer different aesthetic and photometric options.

Where illumination is required, the Illuminated Surface Mounted Bollard from Bailey Streetscene really does light the way.

H: 1100mm x Dia: 150mm



## Materials, Finishes & Options

### Steel

Available in the options below; for further details on our **steel** visit our [materiality page >>](#)

#### Standard



Galvanised

#### Premium



Powder coated

### Stainless steel

Available in the options below; for further details on our **stainless steel** visit our [materiality page >>](#)

#### Standard



Brushed satin

#### Premium



Bright polish

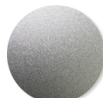

Bead blasted



Mirror Polished

### Fixtures

This product can be customised with a range of optional fixtures. If you have any further bespoke requirements **get in touch**, our sales team will be happy to help.

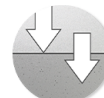

Surface mount / Root fixed





## Multiplicity Illuminated Bollard

The Multiplicity LED Illuminated Bollard shares the graceful visual vocabulary of the collection in which robust verticals end in winged forms. But as well as being a stylish, modern bollard, it's really fit-for-purpose too.

Powered lights can be specified with type 4 or type 5 light distributions to provide desired light patterns and illuminance of which are achieved by variations in the number and placement of LED arrays within the luminaire.

L: 352mm x D: 175mm x H: 919mm



## Materials, Finishes & Options

### Fixtures

This product can be customised with a range of optional fixtures. If you have any further bespoke requirements **get in touch**, our sales team will be happy to help.

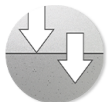

Surface mount  
/ Root fixed



## FGP Illuminated Bollard

If you want your bollards to add a touch of class to your outdoor space.....

The FGP Illuminated Bollard has an organic form created by three stems that rise from the connection of the base. The soft, triangular head holds LEDs in triangular arrays that cast illumination between the verticals in a clean footprint.

LED light sources are energy efficient and castings are powder coated, making this a stylish, contemporary and popular product which is ideal for any number of outdoor environments.

H: 9713mm x Top Dia: 222mm x Base Dia: 139mm



## Materials, Finishes & Options

### Fixtures

This product can be customised with a range of optional fixtures. If you have any further bespoke requirements **get in touch**, our sales team will be happy to help.

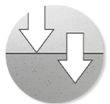

Surface mount  
/ Root fixed





## Lockable Fold Down Post

The fold down post is an extremely popular and inexpensive access control product used for restricting access to driveways and car parking spaces. Base plate secured, the post is 60mm diameter with a total height in the raised position 620mm.

Coming in a striking yellow colour as standard, the cast aluminium base plate is secured by 3No. M12 anchor bolts (not supplied), whilst the post can be locked in the upright or lowered position and is supplied with 2 keys for the cylindrical push button lock. Multiple orders can be supplied keyed alike or keyed to differ. Ground clearance is 102mm. Powder coat finish available in Black.

H: 620mm x Dia: 60mm

**TECHNICAL  
DRAWINGS  
AVAILABLE ON  
REQUEST**

**PLEASE CONTACT  
OUR SALES TEAM**

## Materials, Finishes & Options

### Steel

Available in the options below;  
for further details on our **steel** visit our **materiality page >>**

#### Standard Premium

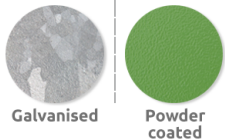

### Colours

Available in a huge range of **RAL** colours.

Our most popular colours are;

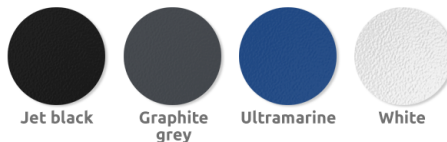

### Fixtures

This product can be customised with a range of optional fixtures. If you have any further bespoke requirements **get in touch**, our sales team will be happy to help.

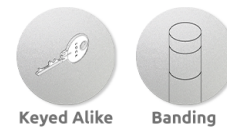



## Fold Down Parking Post

To give you an extra level of security to buildings as well being convenient for reserving parking space or controlling access, the Fold Down Parking Post is a superb, cost-effective method of reserving car park spaces. It comes galvanised and surface mounted, and its base is secured by 3 x M12 bolts (padlock & bolts supplied).

This is a great, value-for-money access control product from Bailey Streetscene.  
H: 620mm x Dia: 63mm

**TECHNICAL  
DRAWINGS  
AVAILABLE ON  
REQUEST**

**PLEASE CONTACT  
OUR SALES TEAM**

## Materials, Finishes & Options

### Steel

Available in the options below;  
for further details on our **steel** visit our **materiality page >>**

#### Standard



Galvanised

#### Premium



Powder coated

### Colours

Available in a huge range of RAL colours.

Our most popular colours are;



Jet black

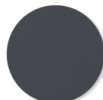

Graphite grey



Ultramarine



White

### Fixtures

This product can be customised with a range of optional fixtures. If you have any further bespoke requirements **get in touch**, our sales team will be happy to help.



Keyed Alike



Banding





## Warrior HD Square Telescopic Bollard

We supply a number of Warrior products, and the Warrior HD Square Telescopic Bollard does exactly as its name implies: it's absolutely ideal for protecting driveways and restricting unauthorised vehicular access. The Warrior HD Square Telescopic Bollard has an integral security lock and comes galvanised finish as standard, with an option for being powder coated.

H: 670mm x D: 90mm

**TECHNICAL  
DRAWINGS  
AVAILABLE ON  
REQUEST**

**PLEASE CONTACT  
OUR SALES TEAM**

## Materials, Finishes & Options

**Steel**  
 Available in the options below;  
 for further details on our **steel** visit our **materiality page >>**

### Colours

Available in a huge range of **RAL** colours.

Our most popular colours are;

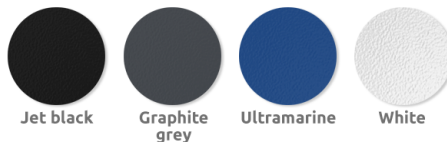
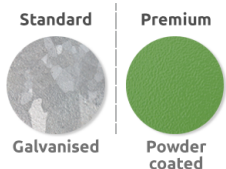

### Fixtures

This product can be customised with a range of optional fixtures. If you have any further bespoke requirements **get in touch**, our sales team will be happy to help.

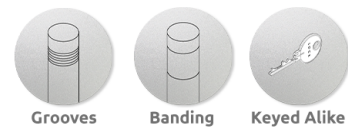



## Warrior HD Round Telescopic Bollard

We supply a number of Warrior products, and the Warrior HD Round Telescopic Bollard does exactly as its name implies: it's absolutely ideal for protecting driveways and restricting unauthorised vehicular access. The Warrior HD Round Telescopic Bollard has an integral security lock and comes galvanised finish as standard, with an option for being powder coated.

H: 670mm x Dia: 90mm

**TECHNICAL  
DRAWINGS  
AVAILABLE ON  
REQUEST**

**PLEASE CONTACT  
OUR SALES TEAM**

## Materials, Finishes & Options

### Steel

Available in the options below;  
for further details on our **steel** visit our **materiality page >>**

#### Standard

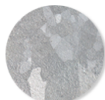

Galvanised

#### Premium



Powder coated

### Colours

Available in a huge range of **RAL** colours.

Our most popular colours are;



Jet black

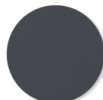

Graphite grey



Ultramarine



White

### Fixtures

This product can be customised with a range of optional fixtures. If you have any further bespoke requirements **get in touch**, our sales team will be happy to help.



Grooves



Banding



Keyed Alike



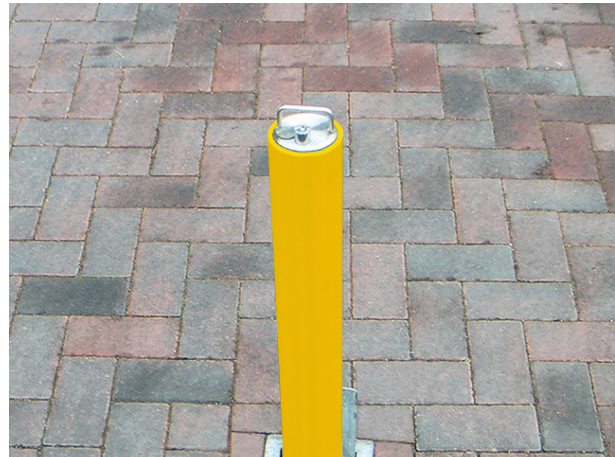

## Warrior Standard Round Telescopic Bollard

The Warrior Standard Round Telescopic Bollard has an integral security lock and comes galvanised finish as standard. You also have the option of this bollard being powder coated, making it a great choice for cordoning off an area or protecting car parks or any outdoor spaces.

H: 670mm x Dia: 90mm

**TECHNICAL  
 DRAWINGS  
 AVAILABLE ON  
 REQUEST**

**PLEASE CONTACT  
 OUR SALES TEAM**

## Materials, Finishes & Options

**Steel**  
 Available in the options below;  
 for further details on our **steel** visit our **materiality page >>**

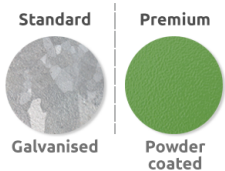

**Colours**  
 Available in a huge range of **RAL** colours.  
 Our most popular colours are;

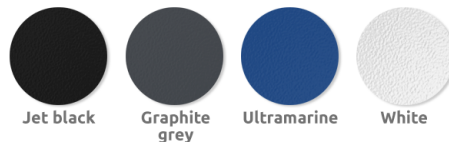

**Fixtures**  
 This product can be customised with a range of optional fixtures. If you have any further bespoke requirements **get in touch**, our sales team will be happy to help.

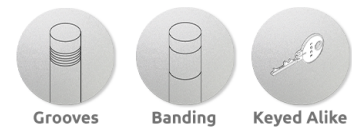



## Warrior Stainless Steel Standard Round Telescopic Bollard

The Warrior Stainless Steel Standard Round Telescopic Bollard has an integral security lock. It's made from Grade 304 stainless steel, and comes with a galvanised steel ground socket. This is a strong, durable bollard that is really popular with our customers and is ideal for protecting car parks, driveways or any other public parking spaces, or for cordoning off outdoor areas.

H: 670mm x Dia: 90mm

**TECHNICAL  
 DRAWINGS  
 AVAILABLE ON  
 REQUEST**

**PLEASE CONTACT  
 OUR SALES TEAM**

## Materials, Finishes & Options

**Stainless steel**  
 Available in the options below;  
 for further details on our **stainless steel**  
 visit our **materiality page >>**

**Fixtures**  
 This product can be customised with a range of optional  
 fixtures. If you have any further bespoke requirements  
**get in touch**, our sales team will be happy to help.

Standard

Premium



Brushed  
satin



Bright  
polish



Bead  
blasted



Mirror  
Polished



Grooves



Banding



Keyed Alike





## Warrior HD Large Round Telescopic Bollards

The Warrior HD Large Round Telescopic Bollards are cost-effective, simple, and durable Bailey Streetscene products, and provide the security and accessibility that more and more people want. It has an integral security lock and comes galvanised finish as standard, and can be powder coated, ensuring that this strong bollard is ideal for protecting car parks, driveways or any other public parking spaces, or for cordoning off areas.

H: 850mm x Dia: 114mm

**TECHNICAL  
DRAWINGS  
AVAILABLE ON  
REQUEST**

**PLEASE CONTACT  
OUR SALES TEAM**

## Materials, Finishes & Options

### Steel

Available in the options below;  
for further details on our **steel** visit our **materiality page >>**

#### Standard



Galvanised

#### Premium



Powder coated

### Colours

Available in a huge range of **RAL** colours.

Our most popular colours are;



Jet black



Graphite grey



Ultramarine



White

### Fixtures

This product can be customised with a range of optional fixtures. If you have any further bespoke requirements **get in touch**, our sales team will be happy to help.



Grooves



Banding



Keyed Alike

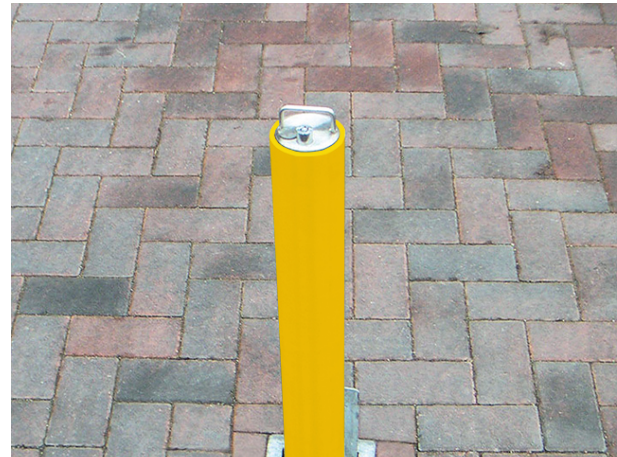

## Warrior Driveway Telescopic Bollard

We supply a number of Warrior products and the Warrior Driveway Telescopic Bollard does exactly as its name implies: it's absolutely ideal for protecting driveways and restricting unauthorised vehicular access.

With a galvanised finish coming as standard, this can be powder coated to most BS or RAL colours, and has an integral 10 pin high security lock. Keyed alike or to differ.  
 H: 580mm x Dia: 76mm

**TECHNICAL  
 DRAWINGS  
 AVAILABLE ON  
 REQUEST**

**PLEASE CONTACT  
 OUR SALES TEAM**

## Materials, Finishes & Options

**Steel**  
 Available in the options below;  
 for further details on our **steel** visit our **materiality page >>**

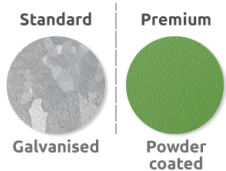

**Colours**  
 Available in a huge range of RAL colours.  
 Our most popular colours are;

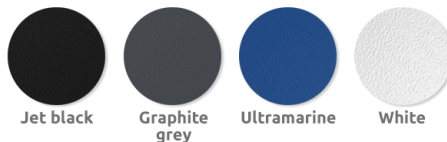

**Fixtures**  
 This product can be customised with a range of optional fixtures. If you have any further bespoke requirements **get in touch**, our sales team will be happy to help.

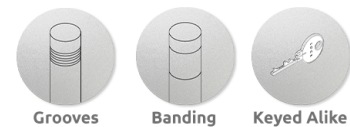



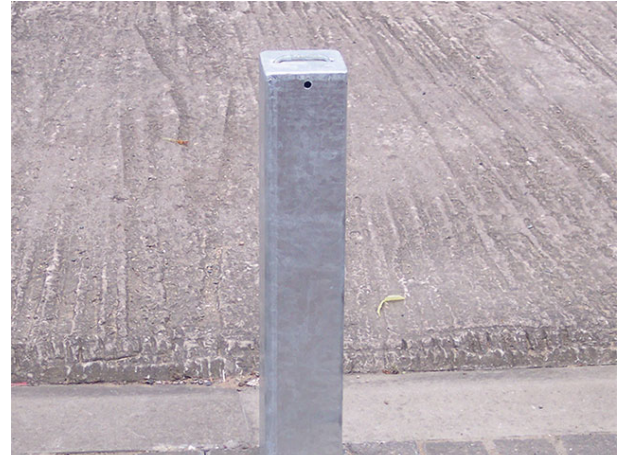

## Telescopic Mole Post

The post has a hot dipped galvanised finish and locates into a socket embedded in concrete. The post stands 610mm above ground with a 100mm box section, providing effective security for garage forecourts, driveways, car parks as well being extremely useful as a variety of other applications, such as cordoning off areas.

This is a cost-effective, popular product and is designed to retract into the ground when not in use and is manually raised into its protecting position and secured by means of a padlock (not supplied).

H:785mm x D: 100mm x Weight: 23Kgs

**TECHNICAL  
DRAWINGS  
AVAILABLE ON  
REQUEST**

**PLEASE CONTACT  
OUR SALES TEAM**

## Materials, Finishes & Options

### Steel

Available in the options below;  
for further details on our **steel** visit our **materiality page >>**

### Colours

Available in a huge range of **RAL** colours.

Our most popular colours are;

### Fixtures

This product can be customised with a range of optional fixtures. If you have any further bespoke requirements **get in touch**, our sales team will be happy to help.

#### Standard

#### Premium



Galvanised



Powder coated



Stainless steel



Corten



Jet black

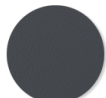

Graphite grey



Ultramarine



White



Grooves



Banding



Keyed Alike



## Telescopic Traffic Stopper

This bollard stands 660mm above ground with a 120mm box section, making this Telescopic Post a larger, stronger and more substantial version of the Telescopic Mole Post.

The Telescopic Traffic Stopper has a hot dipped galvanised finish and locates into a socket embedded in concrete. It's a simple, strong bollard that gives great accessibility and security to our customers and is ideal for protecting car parks, driveways or any other public parking spaces, or for cordoning off areas.

H: 914mm x D: 120mm x Weight: 41Kgs

**TECHNICAL  
DRAWINGS  
AVAILABLE ON  
REQUEST**

**PLEASE CONTACT  
OUR SALES TEAM**

## Materials, Finishes & Options

### Steel

Available in the options below;  
for further details on our **steel** visit our **materiality page >>**

#### Standard



Galvanised

#### Premium



Powder coated

### Colours

Available in a huge range of **RAL** colours.

Our most popular colours are;

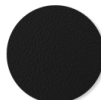

Jet black

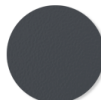

Graphite grey



Ultramarine



White

### Fixtures

This product can be customised with a range of optional fixtures. If you have any further bespoke requirements **get in touch**, our sales team will be happy to help.



Grooves



Banding



Keyed Alike





## Heavy Duty Removable Bollard

If you're looking for a tough, durable and hard-wearing bollard then the Heavy Duty Removable Bollard is a great choice. Superb for restricting access and preventing unauthorised entry of vehicles, the bollard locates into a socket embedded in concrete.

Available in three sizes, this bollard is locked in position by use of the socket flap and a padlock (not supplied). When the bollard is removed the ground socket flap can be padlocked in the closed position keeping the socket free from debris.

The large version is fitted with side lifting handles to assist removal of the bollard. All three versions have amber reflectors on two sides. Standard colour black and white (other colours available on request).

H: 690mm / 965mm / 1100mm

**TECHNICAL  
DRAWINGS  
AVAILABLE ON  
REQUEST**

**PLEASE CONTACT  
OUR SALES TEAM**

## Materials, Finishes & Options

### Steel

Available in the options below;  
for further details on our **steel** visit our **materiality page >>**

#### Standard



Galvanised

#### Premium



Powder coated

### Colours

Available in a huge range of **RAL** colours.

Our most popular colours are;



Jet black



Graphite grey



Ultramarine



White

### Fixtures

This product can be customised with a range of optional fixtures. If you have any further bespoke requirements **get in touch**, our sales team will be happy to help.



Grooves



Banding

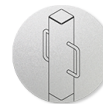

Handles



Padlocks  
Supplied



## Removable Stainless Steel Bollard

This bollard stands 900mm above ground, and its main body is manufactured from grade 304 or 316 stainless steel for more aggressive environments such as industrial or coastal areas. It has a brushed satin finish, with the possibility of a bright polish finish, has a semi dome top, and is root fixed.

It's a smart, contemporary option for ensuring that the edge of a structure, car park, or space is easily and properly identified, or for separating areas.

H : 900mm x Dia : 101mm

**TECHNICAL  
 DRAWINGS  
 AVAILABLE ON  
 REQUEST**

**PLEASE CONTACT  
 OUR SALES TEAM**

## Materials, Finishes & Options

**Stainless steel**  
 Available in the options below;  
 for further details on our **stainless steel**  
 visit our **materiality page >>**

**Fixtures**  
 This product can be customised with a range of optional  
 fixtures. If you have any further bespoke requirements  
**get in touch**, our sales team will be happy to help.

Standard

Premium



Brushed  
satin



Bright  
polish



Bead  
blasted



Mirror  
Polished



Grooves



Banding



Handles



Padlocks  
Supplied





## Removable Steel Bollard

This bollard stands 900mm above ground, has a 90mm diameter and is fitted with red and white hazard band. It's a popular bollard with our customers and comes complete with a ground socket that fits flush with the surface and extends 300mm below ground.

To lock - lift lid - slide the bollard into the ground socket - engage hasp and staple.

To secure - attach a padlock (padlock not supplied).

To remove dis-engage hasp and staple - lift out bollard with integral handle - close lid to remove trip hazard.

An additional ground socket can be supplied to store removed bollards at another location.

H: 1200mm x Dia: 90mm

**TECHNICAL  
DRAWINGS  
AVAILABLE ON  
REQUEST**

**PLEASE CONTACT  
OUR SALES TEAM**

## Materials, Finishes & Options

**Steel**  
 Available in the options below;  
 for further details on our **steel** visit our **materiality page >>**

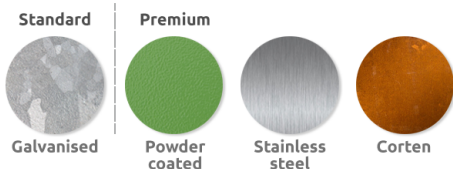

**Colours**  
 Available in a huge range of **RAL** colours.  
 Our most popular colours are;

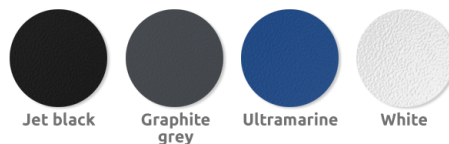

**Fixtures**  
 This product can be customised with a range of optional fixtures. If you have any further bespoke requirements **get in touch**, our sales team will be happy to help.

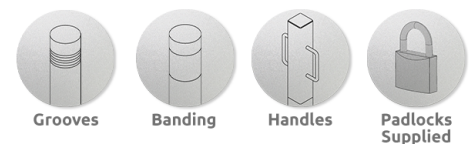



## Heavyweight Key Operated Post

This Heavyweight Key Operated Post fulfils the role where a more substantial post is required. The base is pre-drilled to accept 4 No. M12 anchor bolts, whilst the locks can be supplied with keys the same or to differ.

The post can be supplied with red or black with white banding, making it a brilliant option for outdoor areas such as company or public car parks or driveways.

H: 762mm x Dia: 89mm x Ground clearance: 110mm x Weight: 10Kgs

**TECHNICAL  
DRAWINGS  
AVAILABLE ON  
REQUEST**

**PLEASE CONTACT  
OUR SALES TEAM**

## Materials, Finishes & Options

**Steel**  
 Available in the options below;  
 for further details on our **steel** visit our **materiality page >>**

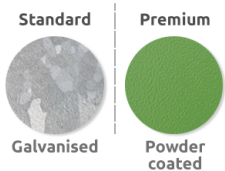

**Colours**  
 Available in a huge range of **RAL** colours.  
 Our most popular colours are;

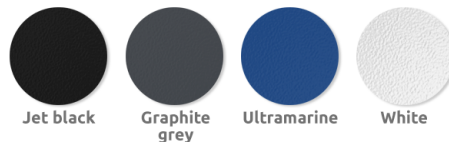

**Fixtures**  
 This product can be customised with a range of optional fixtures. If you have any further bespoke requirements **get in touch**, our sales team will be happy to help.

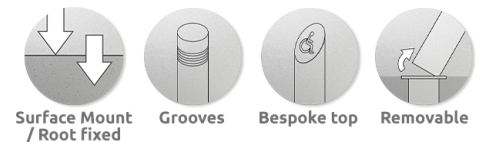





## Timber Bollards

Classically shaped and designed, these bollards are an essential outdoor street product. Manufactured from hot dip galvanised steel and clad in responsibly sourced hard or softwood timber, these aren't only great for your environment but they're helping other environments too!

Coming with a flat top and root fixed or surface mounted, this is a Bailey Streetscene staple.

L: 200mm x D: 200mm x H: 1300mm

**TECHNICAL  
 DRAWINGS  
 AVAILABLE ON  
 REQUEST**

**PLEASE CONTACT  
 OUR SALES TEAM**

## Materials, Finishes & Options

**Timber**  
 Available in the options below;  
 for further details on our **timber** visit our **materiality page >>**

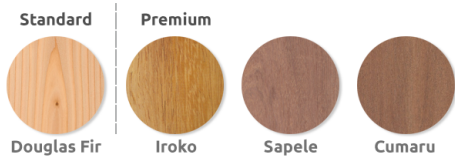

**Fixtures**  
 This product can be customised with a range of optional fixtures. If you have any further bespoke requirements **get in touch**, our sales team will be happy to help.



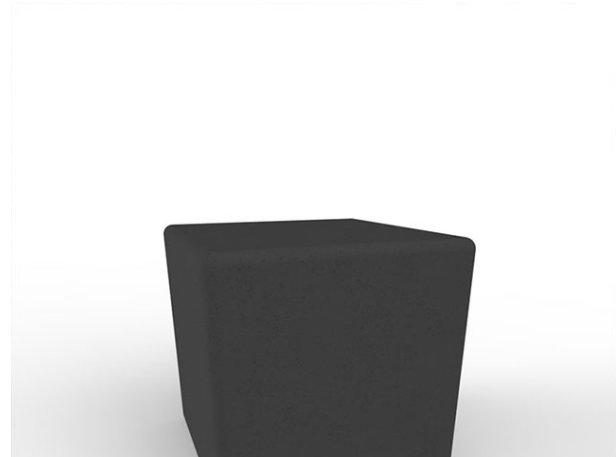
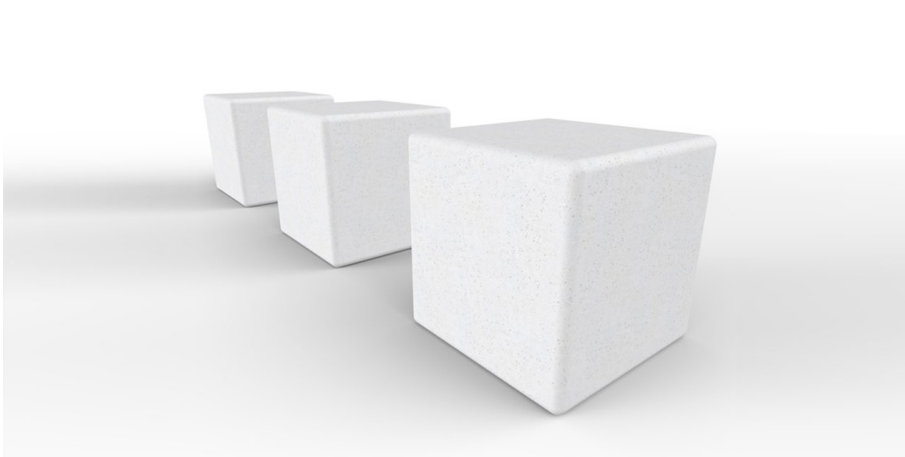

## Harbour Cube

The Harbour Cube is a cube-shaped bench that can be used as a bollard. Manufactured from standard precast concrete with an acid etch finish, for a solid, functional piece of street furniture that is suitable for any outdoor environment, and one that can also be used as a bollard, then the Harbour Cube is an excellent option.

Please note that all concrete products are sealed prior to dispatch.

Colours available: Light Grey. Buff. White. Black.

Finishes available: Light Exposed Aggregate. Fully Polished. Polished Top.  
L: 450mm x D: 450mm x H: 450mm x Weight: 216kg

**TECHNICAL  
DRAWINGS  
AVAILABLE ON  
REQUEST**

**PLEASE CONTACT  
OUR SALES TEAM**

## Materials, Finishes & Options

**Concrete**  
Available in the options below;  
for further details on our **Concrete**  
visit our **materiality page >>**

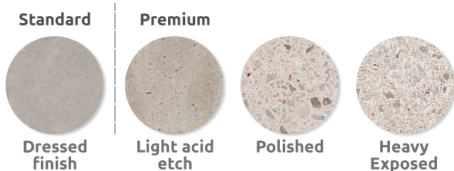

**Concrete colours**  
Available in the options below;  
for further details on our **concrete colours**  
visit our **materiality page >>**



**Fixtures**  
This product can be customised with a range of optional fixtures. If you have any further bespoke requirements **get in touch**, our sales team will be happy to help.

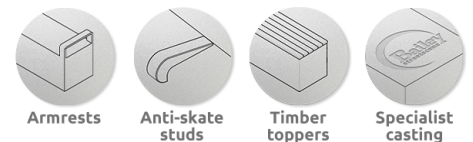





## Lifford Bench

Cylindrically shaped and a product that can be used as a bollard as well as a bench, the Lifford Bench is a flexible piece of street furniture that looks great in any outdoor environment. Available in various sizes, this cube is manufactured from standard precast concrete with an acid etch finish.

For a solid, functional, durable multi-purpose piece of street furniture that is suitable for any outdoor environment, the Lifford Cube is an excellent option. Please note that all concrete products are sealed prior to dispatch.

Finishes available: Light Exposed Aggregate. Fully Polished. Polished Top.  
L: 600mm x D: 600mm x H: 500mm x Weight: 432kg

**TECHNICAL  
DRAWINGS  
AVAILABLE ON  
REQUEST**

**PLEASE CONTACT  
OUR SALES TEAM**

## Materials, Finishes & Options

**Concrete**  
Available in the options below;  
for further details on our **Concrete**  
visit our [materiality page >>](#)

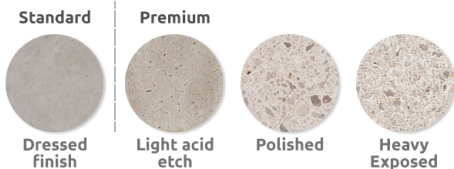

**Concrete colours**  
Available in the options below;  
for further details on our **concrete colours**  
visit our [materiality page >>](#)



**Fixtures**  
This product can be customised with a range of optional fixtures. If you have any further bespoke requirements **get in touch**, our sales team will be happy to help.

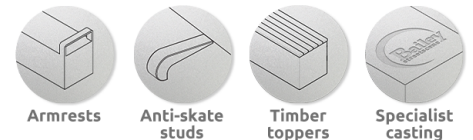



## Harbour Raised Cube

The Harbour Raised Cube is a cube-shaped bench that can be used as a bollard. Manufactured from standard precast concrete with an acid etch finish, if it's simplicity, durability and flexibility that you are after from your street seating then the Harbour Raised Cube ticks all the boxes.

For a solid, functional piece of street furniture that is suitable for any outdoor environment and one that can also be used as a bollard, then the Harbour Raised Cube is an excellent option.

Please note that all concrete products are sealed prior to dispatch.

Colours available: Light Grey. Buff. White. Black.

Finishes available: Light Exposed Aggregate. Fully Polished. Polished Top.  
L: 450mm x D: 450mm x H: 450mm x Weight: 214kg

**TECHNICAL  
DRAWINGS  
AVAILABLE ON  
REQUEST**

**PLEASE CONTACT  
OUR SALES TEAM**

## Materials, Finishes & Options

**Concrete**  
Available in the options below;  
for further details on our **Concrete**  
visit our **materiality page >>**

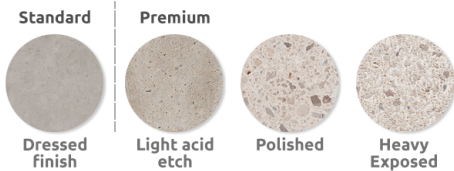

**Concrete colours**  
Available in the options below;  
for further details on our **concrete colours**  
visit our **materiality page >>**



**Fixtures**  
This product can be customised with a range of optional fixtures. If you have any further bespoke requirements **get in touch**, our sales team will be happy to help.

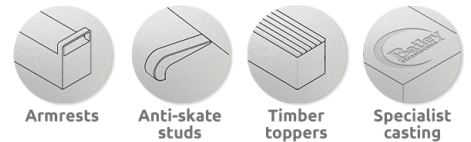





## Ealing Bollard

Put the finishing touches to your car park or any outdoor space with the Ealing Bollard, which is fully cast in Ultrathane 6000 and completely finished in black polyester paint, giving it a sharp, contemporary look. The Ealing Bollard also includes an integral mild steel core with 300mm root and an anchoring bar.

Ensuring that the edge of a structure, car park, or space is easily and properly identified, or for separating areas, these make great solutions.

H: 1120mm x Dia: 185mm x Weight: 31kg



## Materials, Finishes & Options

### Fixtures

This product can be customised with a range of optional fixtures. If you have any further bespoke requirements **get in touch**, our sales team will be happy to help.

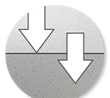

Surface Mount  
/ Root fixed

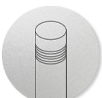

Grooves



Bespoke top



Removable



## Wolstanton Standard Bollard

Put the finishing touches to your car park or any outdoor space with the Wolstanton Standard Bollard, which comes in fully-pigmented, self-finished, high-resistance, low maintenance polyurethane grade 1950. Cast onto a central 114mm diameter steel core with anchoring bars, this comes complete with white class 1 reflective tape at an additional charge.

Ensuring that the edge of a structure, car park, or space is easily and properly identified, or for separating areas, these make great solutions.

H: 930mm x Dia: 140mm

TECHNICAL  
 DRAWINGS  
 AVAILABLE ON  
 REQUEST

-----  
 PLEASE CONTACT  
 OUR SALES TEAM

## Materials, Finishes & Options

### Fixtures

This product can be customised with a range of optional fixtures. If you have any further bespoke requirements **get in touch**, our sales team will be happy to help.

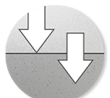

Surface Mount  
/ Root fixed

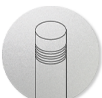

Grooves



Bespoke top



Removable





## Hoop Barrier

Available in 3 lengths and 2 tube diameters, the Hoop Barrier can be standard or reinforced, and comes with a galvanised finish or galvanised and painted in one of our RAL colours. Reinforced models have a horizontal bar at half height and you also have the flexibility of choosing from having base plates or ground sockets as optional extras.

L: 1000mm / 1500mm / 2000mm x Dia: 60mm / 38mm

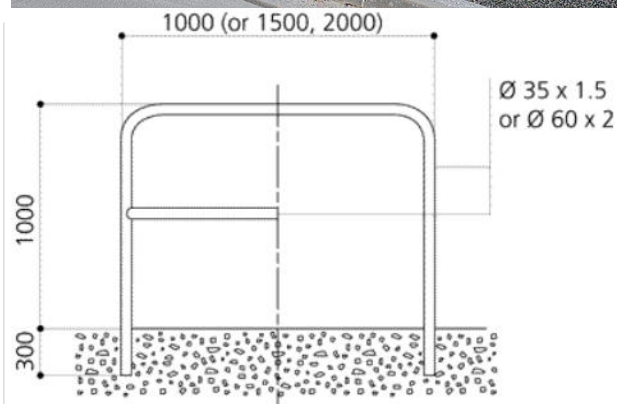

## Materials, Finishes & Options

### Steel

Available in the options below;  
for further details on our **steel** visit our **materiality page >>**

#### Standard



Galvanised

#### Premium



Powder coated



Stainless steel



Corten

### Colours

Available in a huge range of RAL colours.

Our most popular colours are;

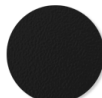

Jet black

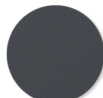

Graphite grey



Ultramarine



White

### Fixtures

This product can be customised with a range of optional fixtures. If you have any further bespoke requirements **get in touch**, our sales team will be happy to help.

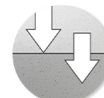

Surface Mount / Root fixed



Tapping Plate



Custom decals



Midrail



## Column Protector

This Column Protector is absolutely ideal for protecting lighting columns, signs and small trees. Manufactured from 60mm diameter steel tube.

Available with 2 or 3 legs.

Surface Mounted or Root Fixed

### Material options

Galvanised Steel Galvanised and Powder Coated Steel Stainless Steel  
**(Guide Price is for Galvanised Steel, Root Fixed, 3 legged option)**

Root Fixed : 775mm x 650mm x 650mm - Surface Mounted : 475mm x 650mm x 650mm

**TECHNICAL  
 DRAWINGS  
 AVAILABLE ON  
 REQUEST**

**PLEASE CONTACT  
 OUR SALES TEAM**

## Materials, Finishes & Options

**Steel**  
 Available in the options below;  
 for further details on our **steel** visit our **materiality page >>**

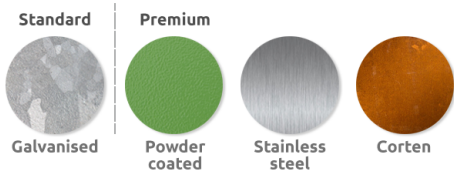

**Colours**  
 Available in a huge range of **RAL** colours.  
 Our most popular colours are;

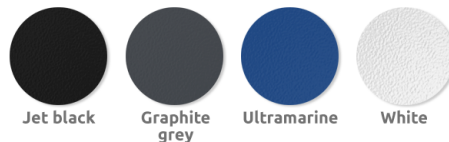

**Fixtures**  
 This product can be customised with a range of optional fixtures. If you have any further bespoke requirements **get in touch**, our sales team will be happy to help.







## Protective Barrier

The Protective Barrier is a decorative and modern bow-shaped barrier ideal for the protection of street and park furniture, shop fronts, trees (as a pair) or notice boards. So, it's a really popular all-rounder of a street furniture product and can be seen in any number of outdoor spaces, such as the car park you see in this photograph.

Protection bar manufactured from steel tube (60mm diameter) fitted with welded steel end caps on two slightly curved feet, the Protective Barrier is galvanised finish or galvanised and painted in one of our RAL colours.

This barrier is to be concreted directly into the ground. Optional base plates, or ground sockets available.

L : 1240mm x D : 365mm x H : 800mm x Dia: 60mm

TECHNICAL  
 DRAWINGS  
 AVAILABLE ON  
 REQUEST

PLEASE CONTACT  
 OUR SALES TEAM

## Materials, Finishes & Options

**Steel**  
 Available in the options below;  
 for further details on our **steel** visit our **materiality page >>**

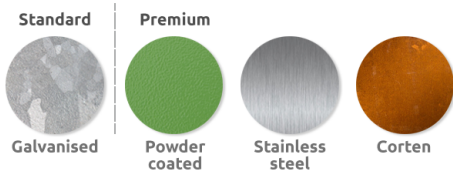

**Colours**  
 Available in a huge range of RAL colours.  
 Our most popular colours are;

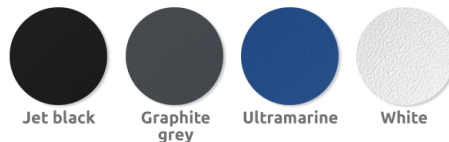

**Fixtures**  
 This product can be customised with a range of optional fixtures. If you have any further bespoke requirements **get in touch**, our sales team will be happy to help.



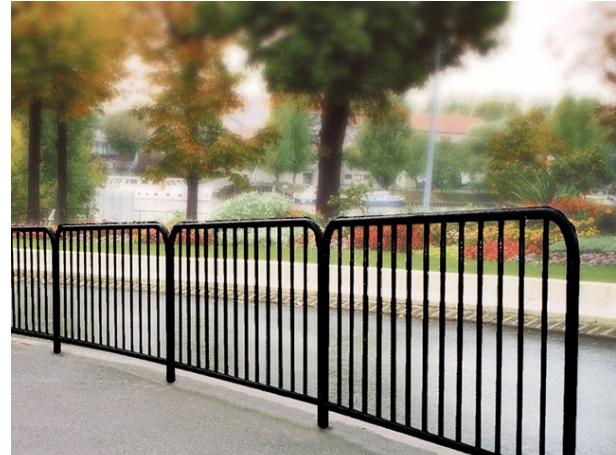

## Safety Guard Rail

If you're looking for safety guard rails that are available in two lengths; 1000mm with 7 infill bars or 2000mm with 13 infill bars, then this is a great product for your chosen outdoor space.

Made from 38mm steel tube with 16mm infill bars galvanised finish or galvanised and painted in one of our RAL colours, these rails are deigned to be concreted directly into the ground.

L: 1000mm / 2000mm

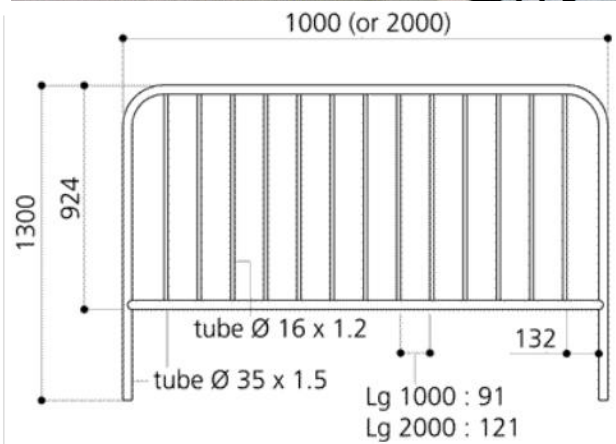

## Materials, Finishes & Options

**Steel**  
 Available in the options below;  
 for further details on our **steel** visit our **materiality page >>**

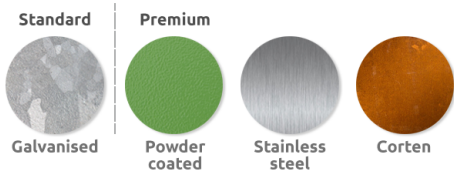

**Colours**  
 Available in a huge range of RAL colours.  
 Our most popular colours are;

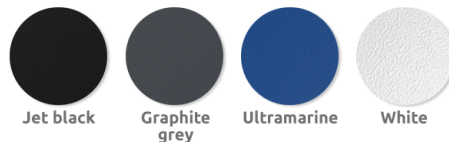

**Fixtures**  
 This product can be customised with a range of optional fixtures. If you have any further bespoke requirements **get in touch**, our sales team will be happy to help.







## Safety Hoop Barrier

If you're looking for a specially designed barrier for protecting your staff and machinery in the work place, then look no further than our Safety Hoop Barrier. Manufactured from 50mm diameter steel tube and available in three versions, this is a standard hoop barrier with additional reinforcement bar and protective panel.

Cast aluminium base plates and reinforcement bar brackets give it a real sturdiness, whilst it features standard hazard warning colours - yellow with black self-adhesive stripes.

L: 1250mm x D: 50mm x H: 1000mm x Dia: 50mm



## Materials, Finishes & Options

**Steel**  
 Available in the options below;  
 for further details on our **steel** visit our **materiality page >>**

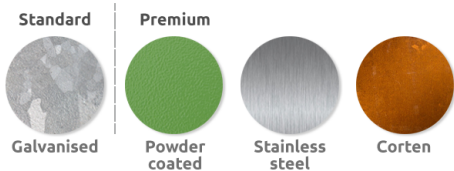

**Colours**  
 Available in a huge range of RAL colours.  
 Our most popular colours are;

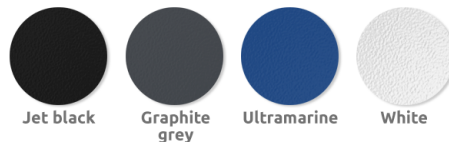

**Fixtures**  
 This product can be customised with a range of optional fixtures. If you have any further bespoke requirements **get in touch**, our sales team will be happy to help.





## Steel Hoop Barriers

Root fixed barriers that are absolutely ideal for securing large perimeters, our Steel Hoop Barriers come with a galvanised finish as standard, or there's an optional powder coating to most BS or RAL colours. We can manufacture steel hoop barriers in a variety of sizes to suit your requirements, making these a superb solution to solving your outdoor barrier problems.

L: 1750mm x H:1050mm x Dia: 60mm

**TECHNICAL  
DRAWINGS  
AVAILABLE ON  
REQUEST**

**PLEASE CONTACT  
OUR SALES TEAM**

## Materials, Finishes & Options

### Steel

Available in the options below;  
for further details on our **steel** visit our **materiality page >>**

### Colours

Available in a huge range of **RAL** colours.

Our most popular colours are;

### Fixtures

This product can be customised with a range of optional fixtures. If you have any further bespoke requirements **get in touch**, our sales team will be happy to help.

#### Standard

#### Premium



Galvanised

Powder coated

Stainless steel

Corten

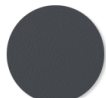
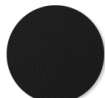

Jet black

Graphite grey

Ultramarine

White

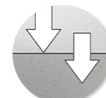

Surface mount / Root fixed





## Heavy Duty Steel Hoop Barriers

These heavy duty barriers come in both fixed and removable versions, giving you additional flexibility of choice for your outdoor space. Perfect for public spaces such as car parks and schools, they feature an integral security lock.

Galvanised as standard, and with the possibility of an optional powder coat finish, these are an excellent, hard-wearing option for any external environment.

Static Version: 76mm diameter. 1750mm long. 1050mm o/a height. Galvanised.

Removable: 76mm diameter. 1500mm long. 650mm above ground. 400mm below.  
H : 1050mm x L : 1750mm x Dia : 76mm

**TECHNICAL  
DRAWINGS  
AVAILABLE ON  
REQUEST**

**PLEASE CONTACT  
OUR SALES TEAM**

## Materials, Finishes & Options

**Steel**  
Available in the options below;  
for further details on our **steel** visit our **materiality page >>**

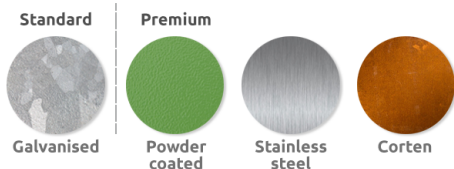

**Colours**  
Available in a huge range of **RAL** colours.  
Our most popular colours are;

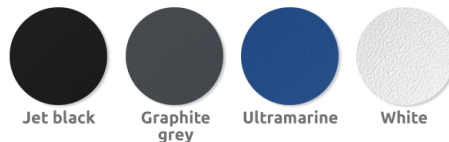

**Fixtures**  
This product can be customised with a range of optional fixtures. If you have any further bespoke requirements **get in touch**, our sales team will be happy to help.





## Pedestrian Guardrail

If you're looking for a durable, effective roadside barrier for pedestrians while allowing good visibility from a motorist's point of view, our Pedestrian Guardrail is an excellent option.

With 12mm solid infill bars, this comes galvanised as standard, and a powder coat option is also available. With a strong, durable vandal-proof structure, the Pedestrian Guardrail is perfect for a wide variety of applications, especially as it's virtually maintenance-free which makes it cost-effective too.

H: 1000mm x L: 2000mm

**TECHNICAL  
 DRAWINGS  
 AVAILABLE ON  
 REQUEST**

**PLEASE CONTACT  
 OUR SALES TEAM**

## Materials, Finishes & Options

**Steel**  
 Available in the options below;  
 for further details on our **steel** visit our **materiality page >>**

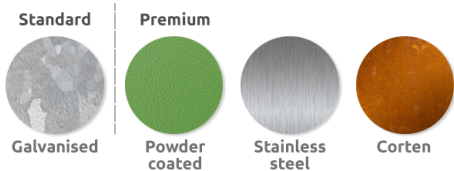

**Colours**  
 Available in a huge range of **RAL** colours.  
 Our most popular colours are;

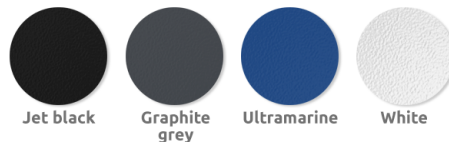

**Fixtures**  
 This product can be customised with a range of optional fixtures. If you have any further bespoke requirements **get in touch**, our sales team will be happy to help.







## Free Standing Safety Guard Rail

Strong and safe with innovative design, our Free Standing Safety Guard Rail does exactly what its name implies. Light yet stable, it has been designed for maximum safety and durability, with a 35mm steel frame, a 1.5mm gauge, and less than 11cm between each bar for increased security.

With four rounded corners and tapered feet for added stability, this is an excellent lightweight barrier option. Finish: galvanised or galvanised then powder coated finish in our RAL colours.

H : 1090mm x L : 2000mm x D : 400mm

**TECHNICAL  
DRAWINGS  
AVAILABLE ON  
REQUEST**

**PLEASE CONTACT  
OUR SALES TEAM**

## Materials, Finishes & Options

**Steel**  
 Available in the options below;  
 for further details on our **steel** visit our **materiality page >>**

### Colours

Available in a huge range of RAL colours.

Our most popular colours are;

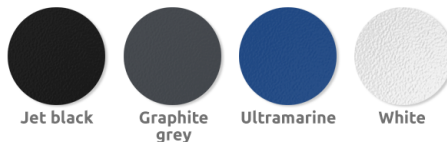
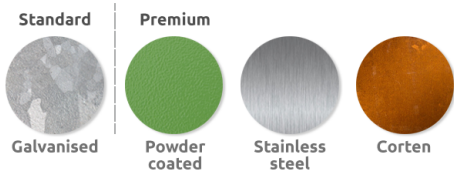



## Sheffield Door Barrier

Manufactured from mild steel and the hot dipped galvanised as standard, stainless steel option available. Can be surface mounted or root fixed. Rubber bung provides protection for doors. Powder Coating available in most BS or RAL colours.

H: 1100mm x L: 750mm x Dia: 48mm

**TECHNICAL  
DRAWINGS  
AVAILABLE ON  
REQUEST**

**PLEASE CONTACT  
OUR SALES TEAM**

## Materials, Finishes & Options

### Steel

Available in the options below;  
 for further details on our **steel** visit our **materiality page >>**

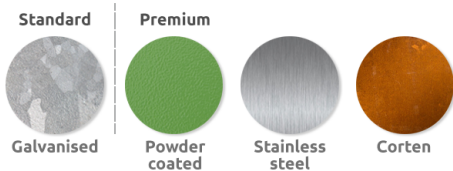

### Stainless steel

Available in the options below;  
 for further details on our **stainless steel** visit our **materiality page >>**



### Fixtures

This product can be customised with a range of optional fixtures. If you have any further bespoke requirements **get in touch**, our sales team will be happy to help.







## Sheffield Infill Door Barrier

The Sheffield Infill Door Barrier is perfect for providing protection at entrances and exits. Ideal for doorways with heavy traffic, such as schools, community centres and other key public building.

Manufactured from mild steel and then hot dipped galvanised as standard with a perforated steel sheet infill. Root fixed.

H: 1100mm x L: 750mm x Dia: 48mm

**TECHNICAL DRAWINGS  
 AVAILABLE ON  
 REQUEST**

**PLEASE CONTACT OUR  
 SALES TEAM**

## Materials, Finishes & Options

**Steel**  
 Available in the options below;  
 for further details on our **steel** visit our **materiality page >>**

**Fixtures**  
 This product can be customised with a range of optional fixtures. If you have any further bespoke requirements **get in touch**, our sales team will be happy to help.

**Standard**



Galvanised

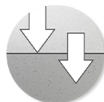

Surface Mount / Root fixed



Tapping Plate

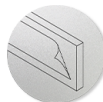

Custom decals



Midrail