

WASTE DISPOSAL





We are far from just a street furniture supplier

As designers, manufacturers and installers of street furniture, canopies and shelters, we pride ourselves on being the go-to experts that can offer you more.

We are determined to ensure that your outdoor space is vibrant, practical, aesthetically pleasing and functional, whilst offering you cost-effective solutions to your outdoor space planning.

As a company, we like to change the way people interact with the outdoor space, and how they view the landscape too.

We are determined to help organisations create outdoor environments that people enjoy walking through, interacting with or simply using it as a stopping and gathering point.

Our resources, flexibility and expertise often enables us to deliver more performance than your budget specifies and we will always go that extra mile for our clients when it comes to providing excellent customer service.

We are proud to have had over three decades of experience and expertise in our sector, allowing us to assist your organisation in choosing the right products for your individual scheme.

We are Bailey Streetscene



Greengate Litter Bin

The Greengate Litter Bin is a circular galvanised steel litter bin with a raised lid that can be surface mounted or root fixed. Fixed to a galvanised steel frame, it's clad in treated vertical timber slats.

Manufactured from mild steel, hot dip galvanised as standard, and powder coating in a range of colours are available on request. The Greengate Litter Bin comes complete with an optional steel liner, and grade 304 stainless steel is also available.
H: 700mm x D: 384mm x Capacity: 50L

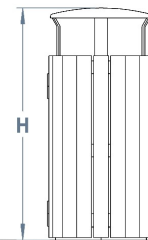
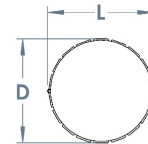

Materials, Finishes & Options

Steel
 Available in the options below;
 for further details on our **steel** visit our **materiality page >>**

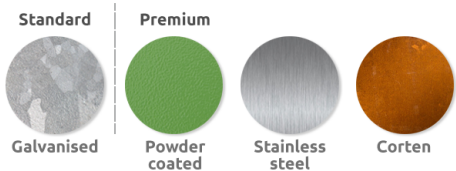

Timber
 Available in the options below;
 for further details on our **timber** visit our **materiality page >>**

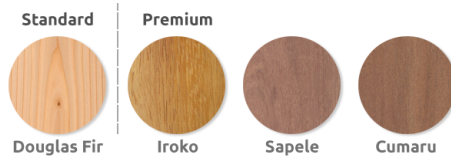

Fixtures
 This product can be customised with a range of optional fixtures. If you have any further bespoke requirements **get in touch**, our sales team will be happy to help.





Ashtray Cigarette Bin

We have a large selection of bins to provide disposal solutions for all types of outdoor environments. Manufactured from steel sheet, lacquered RAL 7016, the Ashtray Cigarette Bin has a removable chrome ashtray. Surface fixed, this would be a great addition to your outdoor space, especially when it's used within our range of smoking shelters.

H: 650mm x Dia: 250mm x Capacity: 2L

**TECHNICAL
DRAWINGS
AVAILABLE ON
REQUEST**

**PLEASE CONTACT
OUR SALES TEAM**

Materials, Finishes & Options

Steel
 Available in the options below;
 for further details on our **steel** visit our **materiality page >>**

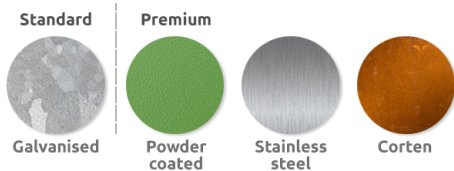

Colours
 Available in a huge range of **RAL** colours.
 Our most popular colours are;

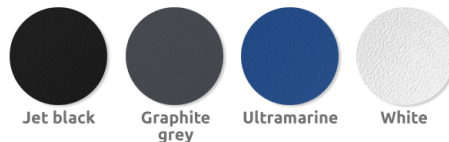

Fixtures
 This product can be customised with a range of optional fixtures. If you have any further bespoke requirements **get in touch**, our sales team will be happy to help.





Buffalo Litter Bin Pyramid Top

Part of the popular Buffalo range of litter bins, this is manufactured using zintec steel, using a three-stage degreasing and washing process. It makes it perfect for tough, frequently-used outdoor environments and features a host of standard features including:

Gold backed LITTER punched beneath apertures. Gold vinyl trim and vinyl Tidyman. Three stainless steel pivot hinges, pivoted on a 20mm S/S rod. Four apertures large enough to accommodate fast food waste including pizza boxes and burger cartons. 1 x 120 Litre galvanised liner. Full height and width door for easy removal/emptying of liner. 4 x fixing holes in base and additional drainage holes. Static liner guides assist easy liner removal and repositioning. 10mm base. Self-emptying ashtray which empties when the door is opened.

As you can see, this is an outstanding product and really cost-effective too. It's also available 80Ltr 100Ltr and 160Ltr versions.

L: 480mm x D: 480mm x H: 1030mm x Capacity: 120L

**TECHNICAL
 DRAWINGS
 AVAILABLE ON
 REQUEST**

**PLEASE CONTACT
 OUR SALES TEAM**

Materials, Finishes & Options

Steel
 Available in the options below;
 for further details on our **steel** visit our **materiality page >>**

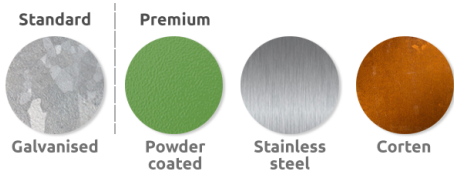

Colours
 Available in a huge range of RAL colours.
 Our most popular colours are;

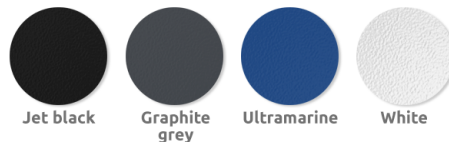

Fixtures
 This product can be customised with a range of optional fixtures. If you have any further bespoke requirements **get in touch**, our sales team will be happy to help.





Bradford Stainless Steel Litter Bin

Part of our Bradford range, the stainless steel litter bin's main body comes in grade 304 or 316 stainless steel for more aggressive environments such as industrial or coastal areas. It's massively popular in densely populated areas such as outdoor shops and shopping centres. It comes with a brushed satin finish, 90 Litre galvanised liner, and an anti-tamper security lock for added protection and peace of mind.

It also features a pivoting lid allowing the easy removal of the liner, and a keyless integrated ashtray with easy empty tray built into the post, making it a highly sought-after solution to your outdoor litter disposal problems.

L: 650mm x D: 500mm x H: 1310mm x Capacity: 90L

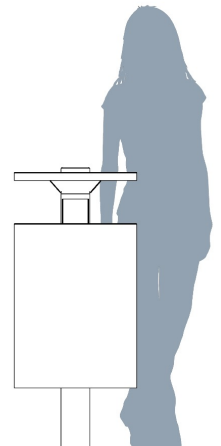
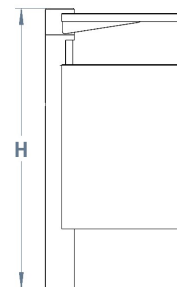
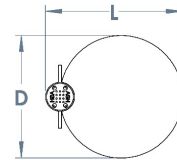

Materials, Finishes & Options

Stainless steel
 Available in the options below;
 for further details on our **stainless steel**
 visit our **materiality page >>**

Fixtures
 This product can be customised with a range of optional
 fixtures. If you have any further bespoke requirements
get in touch, our sales team will be happy to help.

Standard

Premium



Brushed
satin



Bright
polish



Bead
blasted



Mirror
Polished



Ashtray



Lettering

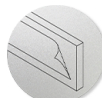

Custom
decals

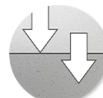

Surface Mount
/ Root fixed



Timber & Steel Litter Bin

The surface mounted Timber & Steel Litter Bin is manufactured from carefully selected and graded hardwood or softwood timbers. As all timber is sourced entirely from commercially-managed, recognised and sustainable resources, you're not only creating a great, suitably resourced outdoor environment for your own space, but you're helping other environments too.

An annual single coat of varnish or stain is recommended to maintain the quality, whilst all steel work is galvanised to British Standard BS EN ISO 1461, making this a really popular Bailey Streetscene product.

L: 530mm x D: 530mm x H: 740mm

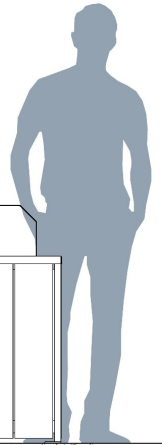
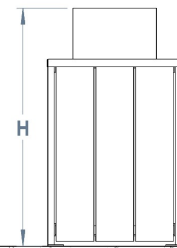
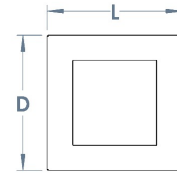

Materials, Finishes & Options

Steel

Available in the options below;
for further details on our **steel** visit our [materiality page >>](#)

Standard



Galvanised

Premium



Powder coated



Stainless steel



Corten

Timber

Available in the options below;
for further details on our **timber** visit our [materiality page >>](#)

Standard



Douglas Fir

Premium



Iroko



Sapele



Cumaru

Fixtures

This product can be customised with a range of optional fixtures. If you have any further bespoke requirements **get in touch**, our sales team will be happy to help.



Ashtray



Lettering

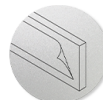

Custom decals

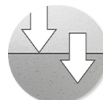

Surface Mount / Root fixed



Buffalo 160 Litre Dual Litter Bin

Part of the popular Buffalo range of litter bins, this 80L Dual Bin is manufactured using zintec steel, using a three-stage degreasing and washing process. It makes it perfect for tough, frequently-used outdoor environments, and stainless steel hinges, locks and strike plates add even more protection - resulting in a robust, quality product.

Optional features include a key operated or self-opening gum and ashtray stubbing plate; anti-graffiti paint, vinyl personalisation, pyramid top, root fixing plate, and 3mm wall thickness. There are various colour choice options available too - even split colour if required!

L: 762mm x D: 425mm x H: 1020mm x Capacity: 160L x Weight: 65kg

TECHNICAL
 DRAWINGS
 AVAILABLE ON
 REQUEST

PLEASE CONTACT
 OUR SALES TEAM

Materials, Finishes & Options

Steel
 Available in the options below;
 for further details on our **steel** visit our **materiality page >>**

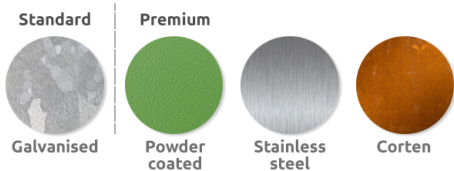

Colours
 Available in a huge range of RAL colours.
 Our most popular colours are;

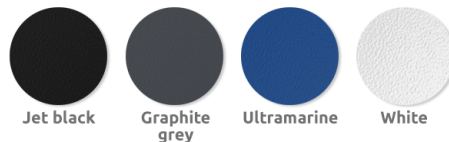

Fixtures
 This product can be customised with a range of optional fixtures. If you have any further bespoke requirements **get in touch**, our sales team will be happy to help.





Buffalo 80 Litre Litter Bin

Part of the popular Buffalo range of litter bins, this 80L bin is manufactured using 2mm zintec steel, using a three-stage degreasing and washing process. It makes it perfect for tough, frequently-used outdoor environments.

The door is full height and width for easy emptying complete with 0.8mm galvanised steel liner with bag retention cord and vinyl tidyman - resulting in a robust, quality product.

Optional features to make it fit perfectly into your outdoor environment include a self-opening gum and ashtray stubbing plate; anti-graffiti paint, vinyl personalisation, root fixing plate, and anti-fly posting paint.

L: 450mm x D: 328mm x H: 1020mm x Capacity: 80L x Weight: 35kg

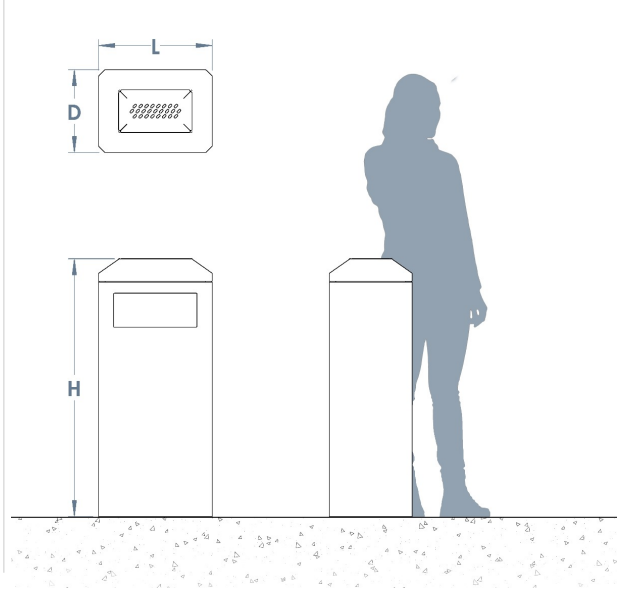

Materials, Finishes & Options

Steel
 Available in the options below;
 for further details on our **steel** visit our **materiality page >>**

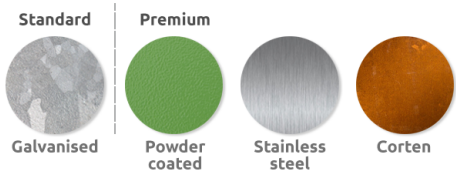

Colours
 Available in a huge range of **RAL** colours.
 Our most popular colours are;

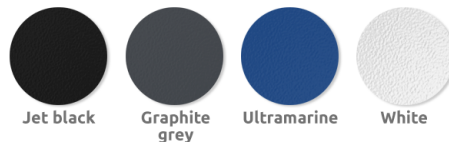

Fixtures
 This product can be customised with a range of optional fixtures. If you have any further bespoke requirements **get in touch**, our sales team will be happy to help.





Buffalo 120 Litre Triple Litter Bin

An integral part of the mighty Buffalo range of litter bins, this 120L triple litter bin is manufactured using 2mm zintec steel, using a three-stage degreasing and washing process. It makes it perfect for tough, frequently-used outdoor environments, and the door is full height and width for easy emptying, whilst the three-bins-in-one design give you flexibility in your litter management.

Please contact our sales team as there are a number of optional extras that can be added to the Buffalo 120 Litre Triple Litter Bin.

L: 1440mm x D: 475mm x H: 1020mm x Capacity: 360L

TECHNICAL
 DRAWINGS
 AVAILABLE ON
 REQUEST

PLEASE CONTACT
 OUR SALES TEAM

Materials, Finishes & Options

Steel
 Available in the options below;
 for further details on our **steel** visit our **materiality page >>**

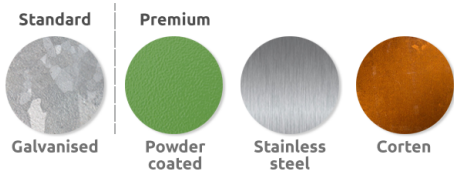

Colours
 Available in a huge range of RAL colours.
 Our most popular colours are;

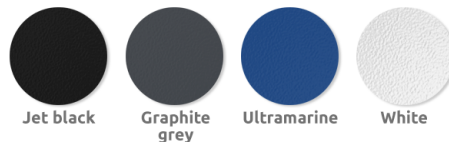

Fixtures
 This product can be customised with a range of optional fixtures. If you have any further bespoke requirements **get in touch**, our sales team will be happy to help.





Buffalo 120 Litre Litter Bin

Part of the mighty Buffalo range of litter bins, this 120L bin is manufactured using 2mm zintec steel, using a three-stage degreasing and washing process. It makes it perfect for tough, frequently-used outdoor environments, and the door is full height and width for easy emptying.

Please contact our sales team as there are a number of optional extras that can be added to the Buffalo 120 Litre Litter Bin.

L: 450mm x D: 328mm x H: 1020mm x Capacity: 120L

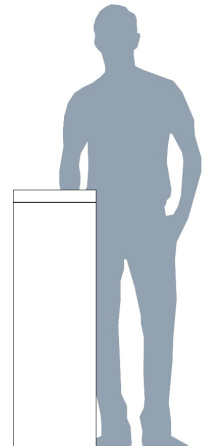
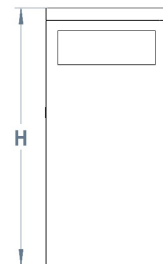
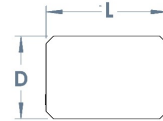

Materials, Finishes & Options

Steel
 Available in the options below;
 for further details on our **steel** visit our **materiality page >>**

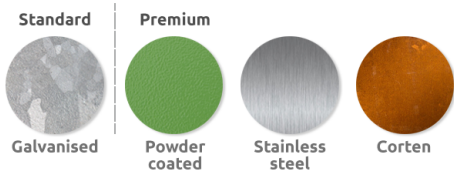

Colours
 Available in a huge range of RAL colours.
 Our most popular colours are;

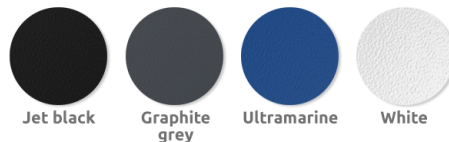

Fixtures
 This product can be customised with a range of optional fixtures. If you have any further bespoke requirements **get in touch**, our sales team will be happy to help.





Buffalo 240 Litre Litter Bin

Part of the mighty Buffalo range of litter bins, this 240L bin is manufactured using zintec steel, using a three-stage degreasing and washing process. It makes it perfect for tough, frequently-used outdoor environments, and stainless steel hinges, locks and strike plates add even more protection - resulting in a robust, quality product.

Optional features include a key operated or self-opening gum and ashtray stubbing plate; anti-graffiti paint, vinyl personalisation, pyramid top, root fixing plate, and 3mm wall thickness. There are various colour choice options available too - even split colour if required!

L: 960mm x D: 480mm x H: 1030mm x Capacity: 240L x Weight: 85kg

TECHNICAL
DRAWINGS
AVAILABLE ON
REQUEST

PLEASE CONTACT
OUR SALES TEAM

Materials, Finishes & Options

Steel

Available in the options below;
 for further details on our **steel** visit our **materiality page >>**

Standard



Galvanised

Premium



Powder coated



Stainless steel



Corten

Colours

Available in a huge range of RAL colours.

Our most popular colours are;

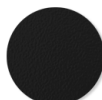

Jet black

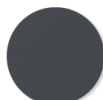

Graphite grey



Ultramarine



White

Fixtures

This product can be customised with a range of optional fixtures. If you have any further bespoke requirements **get in touch**, our sales team will be happy to help.



Ashtray



Lettering

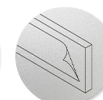

Custom decals

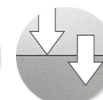

Surface Mount / Root fixed



Chelsea Litter Bin

The Chelsea Litter Bin is front opening and has a 90 litre capacity galvanised steel liner and a full length door hinge, with an integral ashtray. Manufactured from 3mm thick vandal resistant stainless steel it has durability and longevity. You can add a personal touch too, as logos or lettering can be incorporated to add a bespoke look to this product.

Available as a full stainless steel unit or a powder coated steel frame with timber clad door.

Contact our team for more information regarding prices and finishes.

L: 525mm x D: 260mm x H: 905mm x Capacity: 90L

**TECHNICAL
DRAWINGS
AVAILABLE ON
REQUEST**

**PLEASE CONTACT
OUR SALES TEAM**

Materials, Finishes & Options

Stainless steel

Available in the options below;
for further details on our **stainless steel**
visit our **materiality page >>**

Standard



Brushed
satin

Premium



Bright
polish



Bead
blasted



Mirror
Polished

Fixtures

This product can be customised with a range of optional
fixtures. If you have any further bespoke requirements
get in touch, our sales team will be happy to help.



Ashtray



Lettering

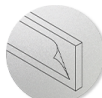

Custom
decals

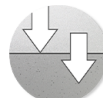

Surface Mount
/ Root fixed



Rushton Litter Bin

This is a smart, sophisticated, contemporary litter bin that also has some size to it too. The Rushton Litter Bin is surface mounted and has a capacity of 150 litres and comes complete with internal slots that will hold a bag liner. Manufactured from grade 304 solid stainless steel, this bin is scratch resistant and very durable. So, it's a litter management solution with style and substance.

With a free-standing base, the Rushton Litter Bin has a top opening, but a side opening feature is also available.

Top opening - Dia: 510mm x H: 840mm
Side opening - Dia: 510mm x H: 1065mm

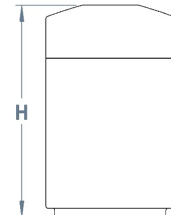
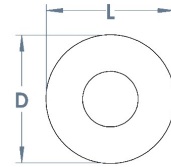

Materials, Finishes & Options

Stainless steel
Available in the options below;
for further details on our **stainless steel**
visit our **materiality page >>**

Standard

Premium



Brushed
satin



Bright
polish



Bead
blasted



Mirror
Polished



DDA
Compliant



Anti-skate
studs

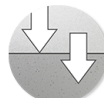

Surface mount
/ Root fixed

Fixtures
This Product can be customised with a range of optional
fixtures. If you have any further bespoke requirements
get in touch, our sales team will be happy to help.



Stoke Litter Bin

If you're looking for a smart, practical litter solution then the Stoke Litter Bin is an excellent choice. Manufactured from 3CR12 stainless steel then powder coated as standard this comes with a capacity of 135 litres complete with galvanised steel liner.

The surface mounted Stoke Litter Bin features a stylish curved covered top and comes complete with laser cut lettering and coloured panel and stainless-steel strip to door top too. A recycling version and an ashtray are optional extras.

L: 660mm x D: 400mm x H: 1085mm x Capacity: 135L

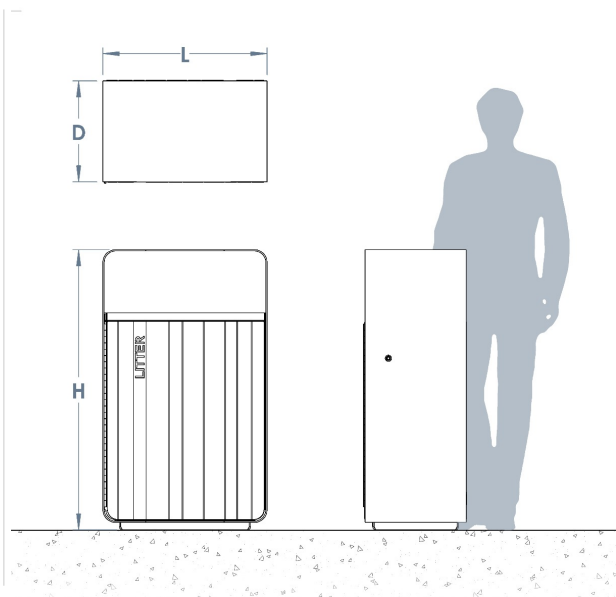

Materials, Finishes & Options

Steel
 Available in the options below;
 for further details on our **steel** visit our **materiality page >>**

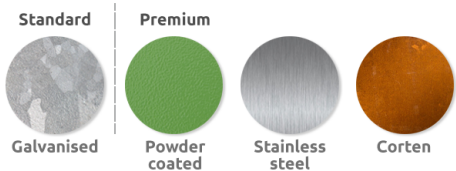

Colours
 Available in a huge range of RAL colours.
 Our most popular colours are;

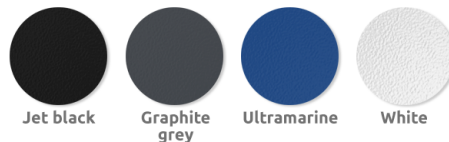

Fixtures
 This product can be customised with a range of optional fixtures. If you have any further bespoke requirements **get in touch**, our sales team will be happy to help.





Ascot Litter Bin

If you're looking for a smart, practical litter solution then the Ascot Litter Bin is an excellent choice. Manufactured from 3CR12 stainless steel then powder coated and clad in hard wearing timbers as standard, but also available with powder coated steel doors or our NEW charred timber option for a sleek, stylish finish. This comes with a capacity of 135 litres complete with galvanised steel liner.

The surface mounted Ascot Litter Bin features a stylish flat covered top and comes complete with laser cut lettering and coloured panel and stainless-steel strip to door top too. A recycling version and an ashtray are optional extras.

L: 660mm x D: 400mm x H: 1085mm x Capacity: 135L

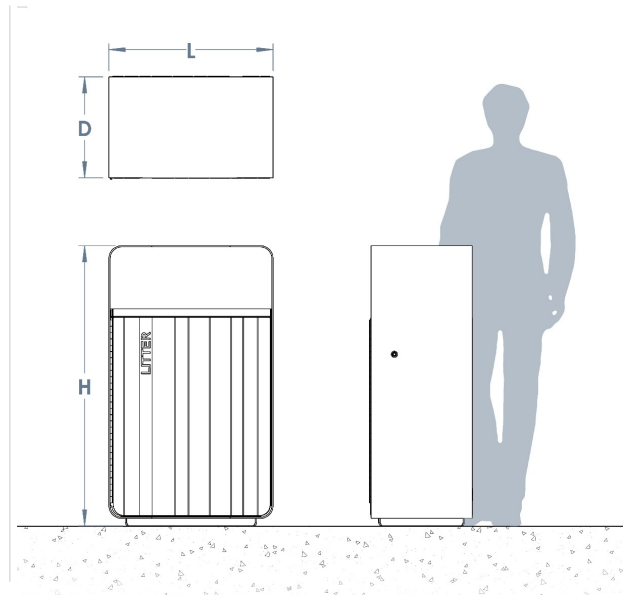

Materials, Finishes & Options

Litter Bin Body

Available in the options below;
 for further details on visit our [materiality page >>](#)

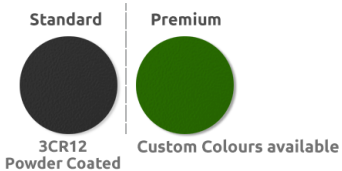

Door Cladding

Available in the options below;
 for further details speak to our sales team >>>

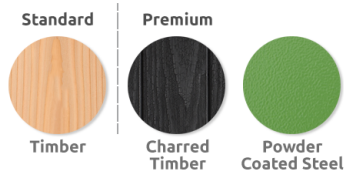

Fixtures

This product can be customised with a range of optional fixtures. If you have any further bespoke requirements **get in touch**, our sales team will be happy to help.





Cannock Litter Bin

This is a large 100L capacity bin, surface mounted, and manufactured from mild steel then hot dipped galvanised as standard. The Cannock Litter Bin also has a galvanised steel liner, and comes complete with door hinge.

You can even customise this litter bin as logos or lettering can be incorporated for personalisation, making it perfect for outdoor spaces such as in schools, parks, or anywhere that you want to add a bespoke touch to your street furniture.

H: 1180mm x Dia: 544mm x Capacity: 100L

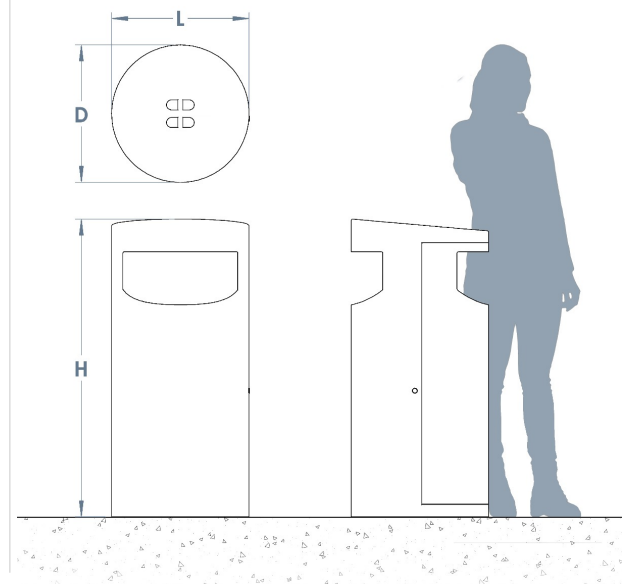

Materials, Finishes & Options

Steel
 Available in the options below;
 for further details on our **steel** visit our **materiality page >>**

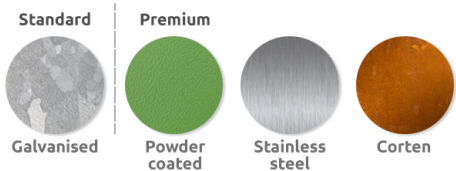

Colours
 Available in a huge range of RAL colours.
 Our most popular colours are;

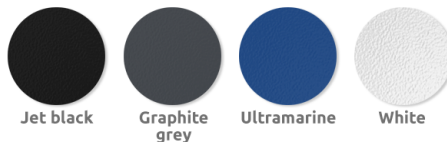

Fixtures
 This product can be customised with a range of optional fixtures. If you have any further bespoke requirements **get in touch**, our sales team will be happy to help.





Ormiston Litter Bin

This is perfect for aggressive outdoor environments such as industrial or coastal areas, due to the Ormiston Litter Bin having a galvanised mild steel frame. Its exterior is recycled plastic cladding, although timber cladding is also available on request, giving you a choice of looks to match the needs of your space.

This front opening litter bin is a great addition to any outdoor setting and matches perfectly the bench, seat and picnic table from the Ormiston range.

L: 500mm x D: 500mm x H: 720mm

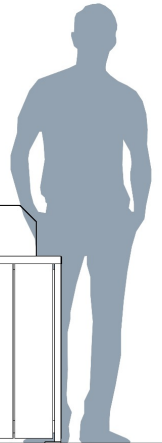
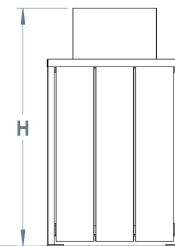
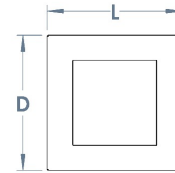

Materials, Finishes & Options

Cladding
 Available in the options below;
 for further details visit our [materiality page >>](#)



Steel
 Available in the options below;
 for further details on our [steel](#) visit our [materiality page >>](#)

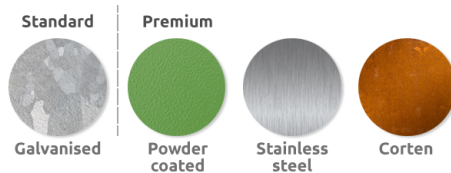

Fixtures
 This product can be customised with a range of optional fixtures. If you have any further bespoke requirements **get in touch**, our sales team will be happy to help.





Versio Orbis Litter Bin

Coming complete with a DIN triangular locking device, and available with or without an ashtray, the Versio Orbis Litter Bin is a popular and durable choice for many clients when choosing a litter bin for any environment - from busy city streets to schools to peaceful public parks.

The Versio Orbis Litter Bin is a circular double-sided steel litter bin manufactured from 5mm laser cut steel with a 40L capacity and a removable inner bin made of stainless steel.

H: 980mm x D: 410mm

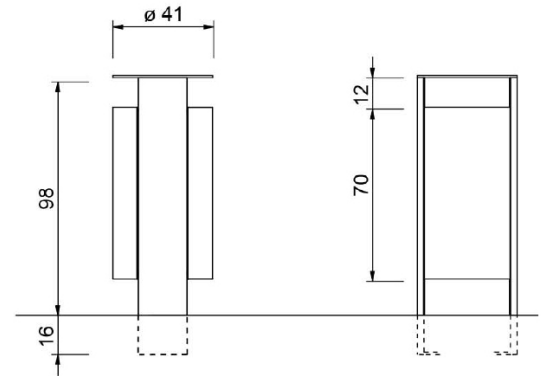

Materials, Finishes & Options

Steel
 Available in the options below;
 for further details on our **steel** visit our **materiality page >>**

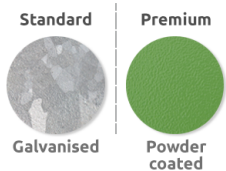

Colours
 Available in a huge range of **RAL** colours.
 Our most popular colours are;

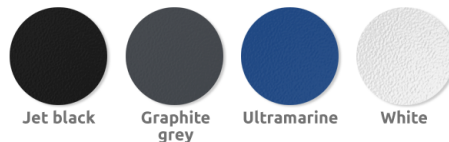

Fixtures
 This product can be customised with a range of optional fixtures. If you have any further bespoke requirements **get in touch**, our sales team will be happy to help.





Legio Litter Bin

If you want a litter bin that gives your outdoor space a touch of elegance, then the contemporary-looking Legio Litter Bin is a great choice. It's a circular double-sided steel litter bin manufactured from rolled 5mm laser cut steel with a 40L capacity, and hosting a DIN triangular locking device.

The removable inner bin is made of stainless steel and the Legio Litter Bin is available with or without an ashtray. Suitable for all outdoor environments.

Litter Bin - L: 380mm x D: 150mm x H: 1000mm x Capacity: 40L
 Cigarette Bin - D: 140mm x H: 880mm

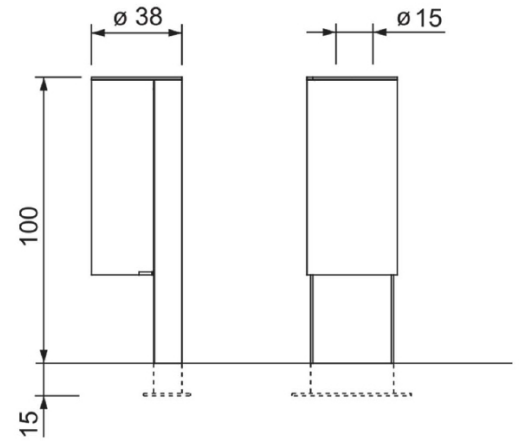

Materials, Finishes & Options

Steel
 Available in the options below;
 for further details on our **steel** visit our **materiality page >>**

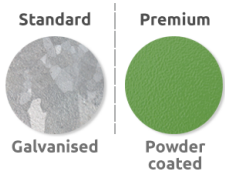

Colours
 Available in a huge range of RAL colours.
 Our most popular colours are;

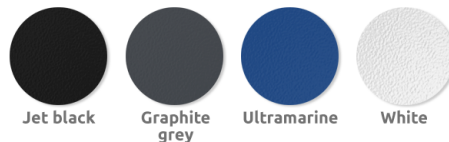

Fixtures
 This product can be customised with a range of optional fixtures. If you have any further bespoke requirements **get in touch**, our sales team will be happy to help.





Urbanis Rund 2 Litter Bin

Renowned for its practicality and durability, the Urbanis Rund 2 Litter Bin is a circular double-sided steel litter bin manufactured from steel. You have a choice of two capacity sizes (50L or 75L) and it has a removable inner bin made of stainless steel and a DIN triangular locking device.

The Urbanis Rund 2 Litter Bin comes available with or without an ashtray, and it really is a superb litter management solution for many outdoor spaces.

Capacity 50L - H: 710mm x D: 440mm
 Capacity 80L - H: 1000mm x D: 440mm

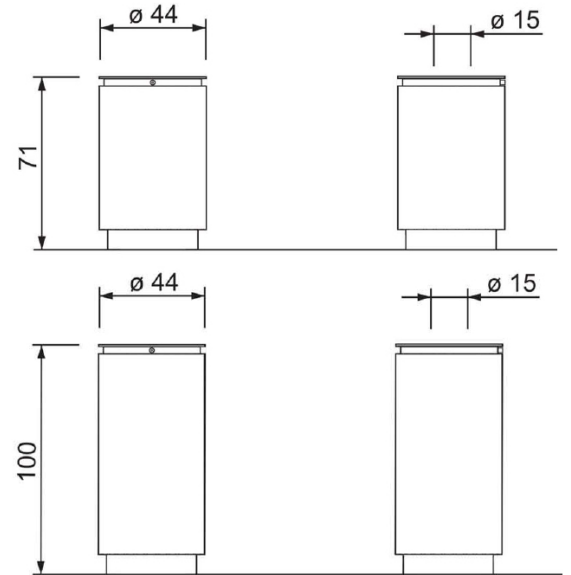

Materials, Finishes & Options

Steel
 Available in the options below;
 for further details on our **steel** visit our **materiality page >>**

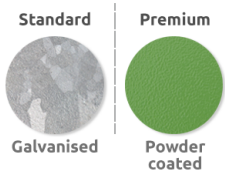

Colours
 Available in a huge range of RAL colours.
 Our most popular colours are;

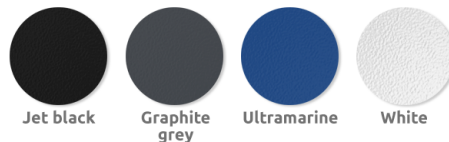

Fixtures
 This product can be customised with a range of optional fixtures. If you have any further bespoke requirements **get in touch**, our sales team will be happy to help.





Urbanis Quadrat Timber Litter Bin

If you want a square litter bin that adds a touch of personality as well as functionality to your outdoor space then the Urbanis Quadrat Timber Litter Bin is a superb option. This is a durable square litter bin manufactured from steel and clad in treated timber slats, and it gives you choice of size too, as it is available with either a 50L or 80L capacity.

The Urbanis Quadrat Timber Litter Bin has a removable inner bin made of stainless steel, a DIN triangular locking device, and is available with or without an ashtray. It really is a superb litter management solution for many outdoor spaces.

Capacity 50L - H: 710mm x D: 440mm
 Capacity 80L - H: 1000mm x D: 440mm

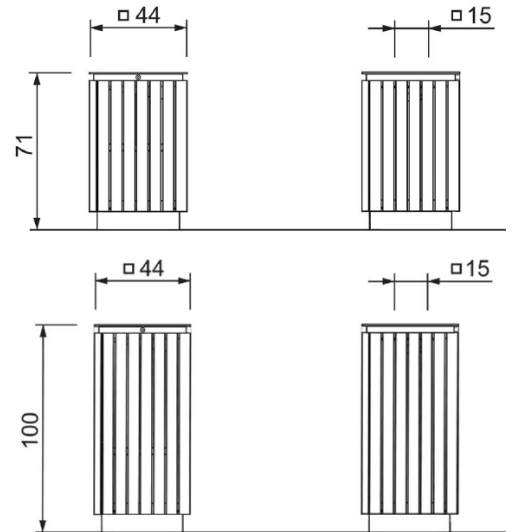

Materials, Finishes & Options

Steel
 Available in the options below;
 for further details on our **steel** visit our **materiality page >>**

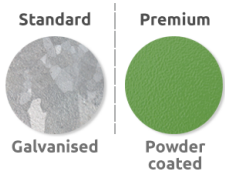

Timber
 Available in the options below;
 for further details on our **timber** visit our **materiality page >>**

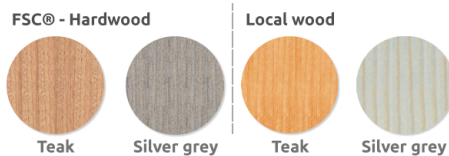

Fixtures
 This product can be customised with a range of optional fixtures. If you have any further bespoke requirements **get in touch**, our sales team will be happy to help.





Argen Litter Bin

The Argen Litter Bin is manufactured from 6mm rolled laser cut steel and is designed to be fitted to an existing post - making it a great choice for any number of outdoor spaces and environments. With a capacity of 35L, this litter bin has a removable inner bin made of stainless steel and a DIN triangular locking device.

The Argen Litter Bin is available with or without an ashtray, and really is a superb litter management solution for many outdoor spaces. Our bins really do contribute to a cleaner, tidier environment and are designed to blend in to your outdoor space; the Argen Litter Bin is a perfect example of this.

H: 800mm x D: 325mm x Capacity: 40L

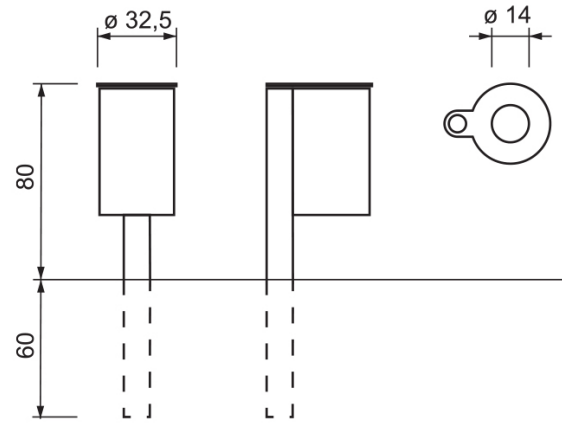

Materials, Finishes & Options

Steel
 Available in the options below;
 for further details on our **steel** visit our **materiality page >>**

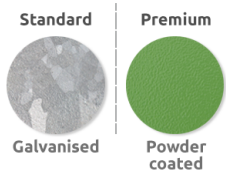

Colours
 Available in a huge range of RAL colours.
 Our most popular colours are;

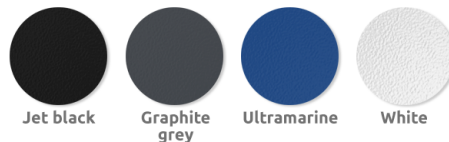

Fixtures
 This product can be customised with a range of optional fixtures. If you have any further bespoke requirements **get in touch**, our sales team will be happy to help.





Orla Litter Bin

Simple and stylish, the Orla Litter Bin is a contemporary design manufactured from 6mm rolled laser cut steel. It has a capacity of 40L and is available with either a dome or flat top, giving you a choice of looks. With a removable inner bin made of stainless steel and a DIN triangular locking device, it is available with or without an ashtray. It really is a superb litter management solution for many outdoor spaces.

Our bins really do contribute to a cleaner, tidier environment and are designed to blend in to your outdoor space, the Orla Litter Bin is a perfect example of this.

H: 800mm x D: 325mm x Capacity: 40L

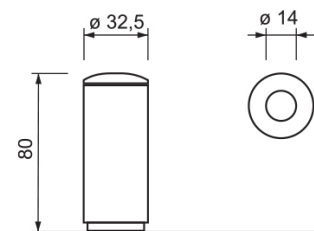
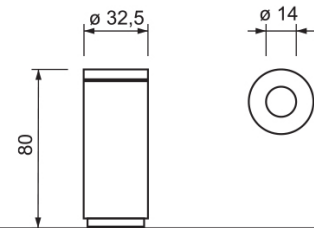

Materials, Finishes & Options

Steel
 Available in the options below;
 for further details on our **steel** visit our **materiality page >>**

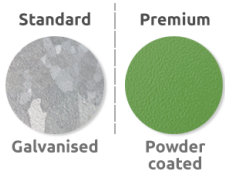

Colours
 Available in a huge range of RAL colours.
 Our most popular colours are;

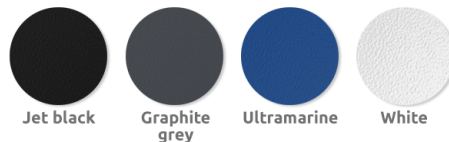

Fixtures
 This product can be customised with a range of optional fixtures. If you have any further bespoke requirements **get in touch**, our sales team will be happy to help.





Urbanis Rund 3 Litter Bin

Renowned for its practicality and durability, the Urbanis Rund 3 Litter Bin is a double-sided steel litter bin manufactured from rolled steel and is clad in timber. You have a choice of two capacity sizes (50L or 75L) and it has a removable inner bin made of stainless steel and a DIN triangular locking device.

The Urbanis Rund 3 Litter Bin comes available with or without an ashtray, and it really is a superb litter management solution for many outdoor spaces.

Capacity 50L - H: 710mm x D: 440mm
 Capacity 75L - H: 1000mm x D: 440mm

**TECHNICAL
 DRAWINGS
 AVAILABLE ON
 REQUEST**

**PLEASE CONTACT
 OUR SALES TEAM**

Materials, Finishes & Options

Steel
 Available in the options below;
 for further details on our **steel** visit our **materiality page >>**

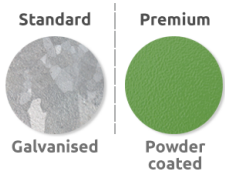

Timber
 Available in the options below;
 for further details on our **timber** visit our **materiality page >>**

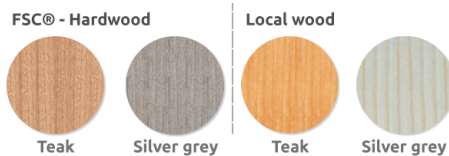

Fixtures
 This product can be customised with a range of optional fixtures. If you have any further bespoke requirements **get in touch**, our sales team will be happy to help.





Versio Corpus Litter Bin

From a range renowned for its practicality, the Versio Corpus Litter Bin is manufactured from 10mm laser cut steel and has a 50L capacity. With a removable inner bin made of stainless steel and a DIN triangular locking device, it is available with or without an ashtray. It really is a superb litter management solution for many outdoor spaces.

Our bins really do contribute to a cleaner, tidier environment and are designed to blend in to your outdoor space too, and the Versio Corpus Litter Bin is a perfect example of this.

L: 380mm x D: 350mm x H: 950mm

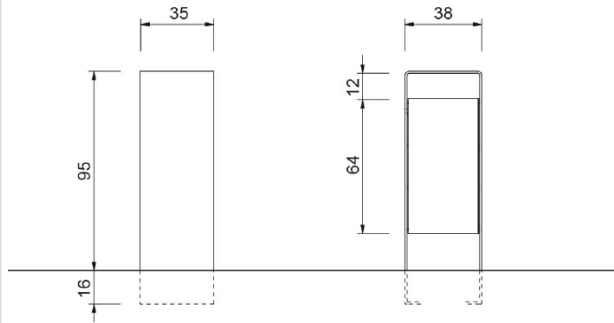

Steel
 Available in the options below;
 for further details on our **steel** visit our **materiality page >>**

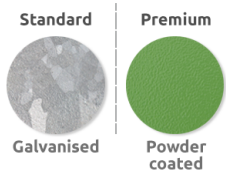

Materials, Finishes & Options

Colours
 Available in a huge range of RAL colours.
 Our most popular colours are;

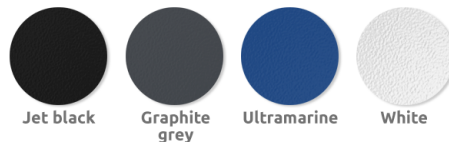

Fixtures
 This product can be customised with a range of optional fixtures. If you have any further bespoke requirements **get in touch**, our sales team will be happy to help.





Deacon Litter Bin

Due to its look and also its toughness and durability, the Deacon Litter Bin really is an ideal solution for waste problems in areas close to nature, as well as schools and inner cities where timber and bright colours are utilised to improve the environment. The Deacon Litter bin features a heavy timber frame, galvanised and powder coated steel door with customisable laser cut lettering and an inner galvanised steel frame to hold waste sacks.

It's available in either soft or hardwood and has a powder coating available in a range of colours on request. Customisable lettering gives the likes of schools, playgrounds and public parks the opportunity to personalise their outdoor space too, whilst it comes either surface mounted or root fixed.

L: 650mm x D: 500mm x H: 1000mm x Capacity: 120L

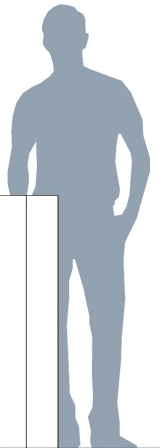
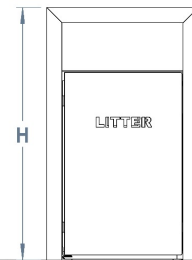
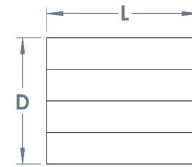

Materials, Finishes & Options

Steel
 Available in the options below;
 for further details on our **steel** visit our **materiality page >>**

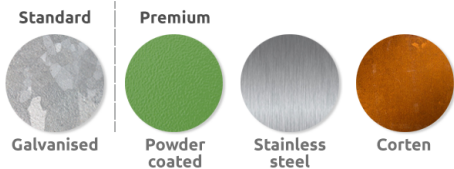

Timber
 Available in the options below;
 for further details on our **timber** visit our **materiality page >>**



Fixtures
 This product can be customised with a range of optional fixtures. If you have any further bespoke requirements **get in touch**, our sales team will be happy to help.





Thistleton Dual Litter Bin

The 240L capacity Thistleton Dual Litter Bin has a classic and rustic design with carefully selected timber slats and exposed black hinges and locks, which makes it absolutely ideal for placing in areas close to nature.

It comes with 2 x 120 Litre galvanised steel lined bins which separate waste, and is surface mounted and hosts lockable doors. Available in either hardwood or softwood, this is a superb choice for the more rural of outdoor spaces.

L: 985mm x D: 480mm (910mm with doors open) x H: 910mm x Capacity 240L

**TECHNICAL
 DRAWINGS
 AVAILABLE ON
 REQUEST**

**PLEASE CONTACT
 OUR SALES TEAM**

Materials, Finishes & Options

Steel
 Available in the options below;
 For further details on our **steel** visit our **materiality page >>**

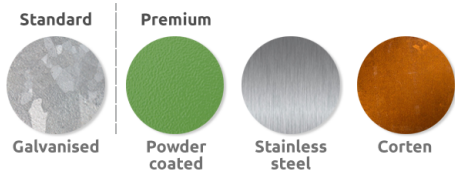

Timber
 Available in the options below;
 For further details on our **timber** visit our **materiality page >>**



Fixtures
 This Product can be customised with a range of optional fixtures. If you have any further bespoke requirements **get in touch**, our sales team will be happy to help.

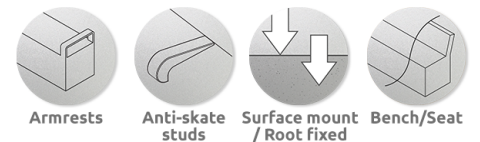



Garnock Litter Bin

Grade 304 stainless steel comes as standard with the Garnock Litter Bin. It's a front opening, modern-looking product and has a 90 litre capacity. With a galvanised steel liner and full length door hinge, this bin is manufactured from 2mm thick vandal resistant stainless steel, and comes with an integral ashtray.

An added bonus is that you can customise the Garnock Litter Bin, as logo's or lettering can be incorporated ensuring you have the choice of personalising your outdoor litter bins.

L: 550mm x D: 420mm x H: 971mm x Capacity: 90L

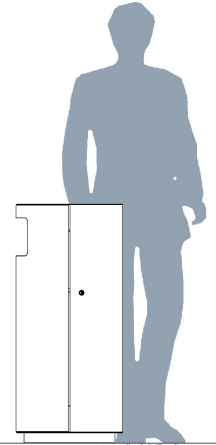
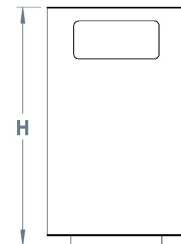
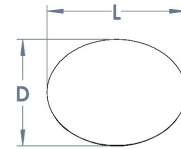

Materials, Finishes & Options

Stainless steel
 Available in the options below;
 for further details on our **stainless steel**
 visit our **materiality page >>**

Fixtures
 This product can be customised with a range of optional
 fixtures. If you have any further bespoke requirements
get in touch, our sales team will be happy to help.

Standard

Premium



Brushed
satin



Bright
polish

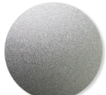

Bead
blasted



Mirror
Polished



Ashtray



Lettering

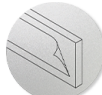

Custom
decals

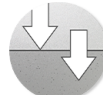

Surface Mount
/ Root fixed



Bradford Recycling Bin

Our new Bradford Recycling Bin's main body comes in grade 304 or 316 stainless steel for more aggressive environments such as industrial or coastal areas. It's also massively popular in densely populated areas such as outdoor shops and shopping centres.

It comes in a brushed satin finish, has a 90 Litre galvanised liner, and comes with an anti-tamper security lock making it a really effective and attractive solution to your outdoor litter disposal problems.

L: 1000mm x D: 500mm x H: 1310mm x Capacity: 180L

TECHNICAL
 DRAWINGS
 AVAILABLE ON
 REQUEST

PLEASE CONTACT
 OUR SALES TEAM

Materials, Finishes & Options

Stainless steel

Available in the options below; for further details on our stainless steel visit our [materiality page](#) >>

Standard



Brushed satin

Premium



Bright polish



Bead blasted



Mirror Polished

Fixtures

This product can be customised with a range of optional fixtures. If you have any further bespoke requirements **get in touch**, our sales team will be happy to help.



Ashtray



Lettering

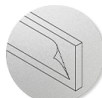

Custom decals

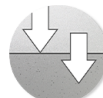

Surface Mount / Root fixed



Multiplicity Litter Bin

An excellent waste solution in a number of outdoor spaces, our new Multiplicity Litter Bin shares a visual vocabulary with the multiplicity illuminated bollard, in which robust verticals end in graceful winged forms. So, it's a modern looking bin suitable for many environments and places.

The litter bin is offered in single and double versions.

L: 361mm x D: 330mm / 662mm x H: 1172mm x Capacity: 68l / 136l



Materials, Finishes & Options

Fixtures

This product can be customised with a range of optional fixtures. If you have any further bespoke requirements **get in touch**, our sales team will be happy to help.



Ashtray



Lettering

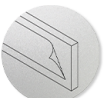

Custom
decals

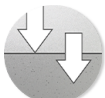

Surface Mount
/ Root fixed



FGP Litter Bin

A contemporary-yet-classic looking bin that will blend in nicely with many outdoor environments, the FGP Litter Bin is a handsome element that complements other pieces in the FGP collection.

The cast aluminium parts have a durable powder coated finish, and the bin has a cast aluminium rim and rotational-moulded base that are connected with vertical timber slats in between. Servicing is made easy through the cast aluminium top being hinged so that it swings up, whilst the attractive timber slats are available in the same species as the bench.

L: 497mm x D: 484mm x H: 937mm x Capacity: 64L



Materials, Finishes & Options

Timber

Available in the options below; for further details on our **timber** visit our **materiality page** >>

Fixtures

This product can be customised with a range of optional fixtures. If you have any further bespoke requirements **get in touch**, our sales team will be happy to help.

Standard

Premium



Douglas Fir



Iroko



Sapele



Cumaru



Ashtray



Lettering

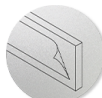

Custom
decals

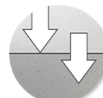

Surface Mount
/ Root fixed



Mac Litter Bin

A surface mounted, wrought iron effect litter bin ideal for the outdoors, the Mac Litter Bin is manufactured from ductile cast iron and has a primed coat with a forge top coat. It can be wall mounted and is also available in stainless steel.

Our bins really do contribute to a cleaner, tidier environment and are designed to blend in to your outdoor space, the Mac Litter Bin a perfect example of this.

L: 415mm x D: 360mm x H: 855mm

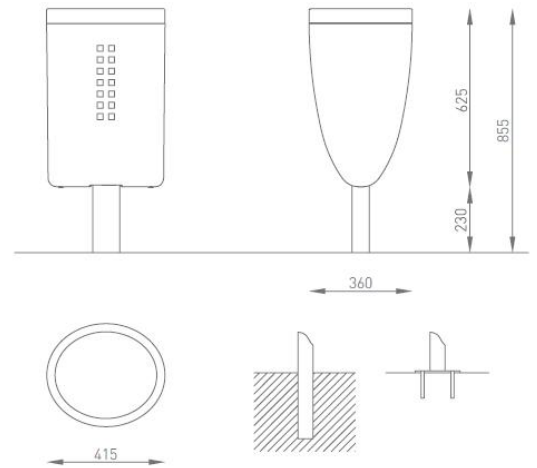

Materials, Finishes & Options

Fixtures

This product can be customised with a range of optional fixtures. If you have any further bespoke requirements **get in touch**, our sales team will be happy to help.



Ashtray



Lettering

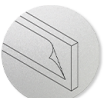

Custom
decals

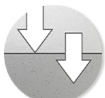

Surface Mount
/ Root fixed



Stainless Steel Cannock Litter Bin

The Stainless Steel Cannock is a large and highly durable Litter Bin, it is manufactured from grade 304 stainless steel and available as a surface or post mounted unit.

Suited for areas with high footfall, with the stain proof shell and easily accessible door.

optional ashtray and customised Decals available.

H: 1180mm x Dia: 544mm x Capacity: 100L

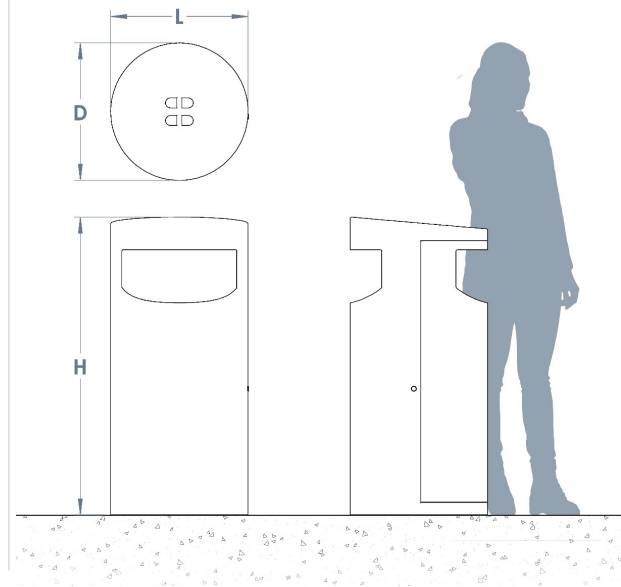

Materials, Finishes & Options

Stainless steel
 Available in the options below;
 for further details on our **stainless steel**
 visit our **materiality page >>**

Fixtures
 This product can be customised with a range of optional
 fixtures. If you have any further bespoke requirements
get in touch, our sales team will be happy to help.

Standard

Premium



Brushed
satin



Bright
polish



Bead
blasted



Mirror
Polished



Ashtray



Lettering



Custom
decals



post mounted



Sanitisation Point - Colombo

Sanitisation Point is a practical and elegant solution suitable for indoor use.

It is designed to be both a hand sanitisation station, and a distribution point for disposable gloves, masks, or wipes.

It is simple and intuitive to use, and specific decals can be applied for a visual indication.

The system also includes a bin with a steel inner liner, to ease the collection and disposal of waste hygienically.

Pre-drilled holes on the front side means the station can be equipped with a battery powered automatic dispenser of hand-sanitiser or with a stainless steel universal bottle holder.

*Price shown is for minimum order of 5 units. Single unit price available on request.

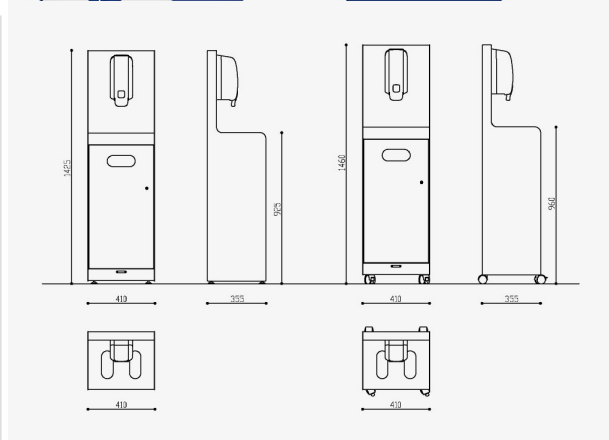

H: 1437mm x L: 408mm x D: 356mm | Capacity 60L | Weight 28kg

Materials, Finishes & Options



Sanitisation Point - Bering

Sanification Point BERING is a practical and intuitive solution for indoor use.

The system includes an openable compartment which can store one bag for waste collection and one box of devices, such as disposable gloves, face-masks or antibacterial wipes. To ease the use, specific decals can be applied for a clear visual indication.

Thanks to appropriate pre-arranged holes on the front side, the module can be equipped with a battery powered automatic dispenser of hand-sanitiser or with a stainless steel universal bottle-holder, making it an elegant and compact hand sanitisation station. The automatic dispenser comes with a practical drop-collector.

*Price shown is for minimum order of 5 units. Single unit price available on request.

[Sanitisation Point Brochure](#)

H: 1440mm x L: 303mm x D: 310mm | Capacity 22L | Weight 21 kg

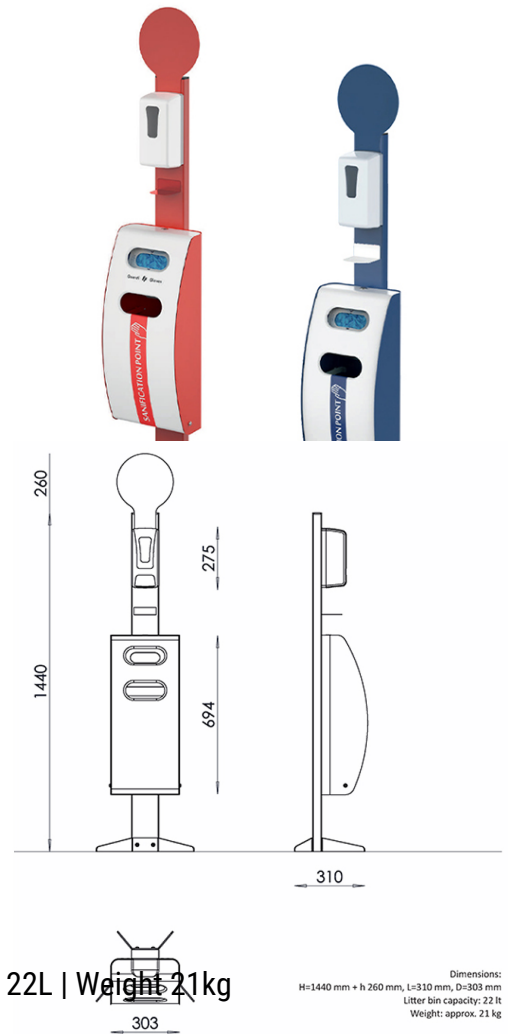

Dimensions:
 H=1440 mm + h 260 mm, L=310 mm, D=303 mm
 Litter bin capacity: 22 lt
 Weight: approx. 21 kg

Materials, Finishes & Options



Sanitisation Point - Magellano

Sanification Point MAGELLANO is a compact solution for the distribution of devices, such as disposable gloves, masks, or wipes, thanks to two removable shelves, easily fixable with knobs.

Suitable for indoor use, it can be also a hand sanitisation station: appropriate pre-arranged holes on the front side of the station, allow to place a battery powered automatic dispenser of hand-sanitiser or a stainless steel universal bottle-holder. The automatic dispenser comes with a practical drop-collector.

Thanks to an optional litterbin with elastic bag holder, the station can become also a point for the collection of waste.

*Price shown is for minimum order of 5 units. Single unit price available on request.
 H: 1440mm x L: 403mm x D: 330mm | Capacity 38L | Weight 14kg

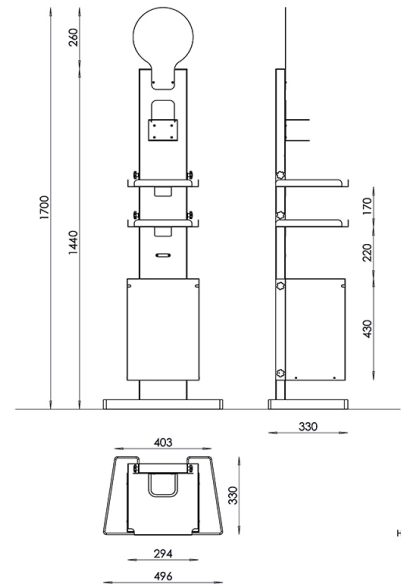

Dimensions:
 H=1440 mm + h 260,50 mm,
 L=403 mm, D=330 mm,
 Inner liner capacity: 38 lt
 Weight: approx. 14 kg

Materials, Finishes & Options



Sanitisation Point - Vespucci

Sanitisation Point VESPUCCI - is the perfect litter bin for indoor use, designed to ease the collection of disposed devices, such as masks, gloves or wipes.

A slit on the top allows to easily throw away the used devices, respecting safety and hygiene. Openable top lid. The bin can be customised with stickers.

*Price shown is for minimum order of 5 units. Single unit price available on request.
 H: 714.5mm x L: 325mm x D: 300mm | Capacity 60L | Weight 9kg

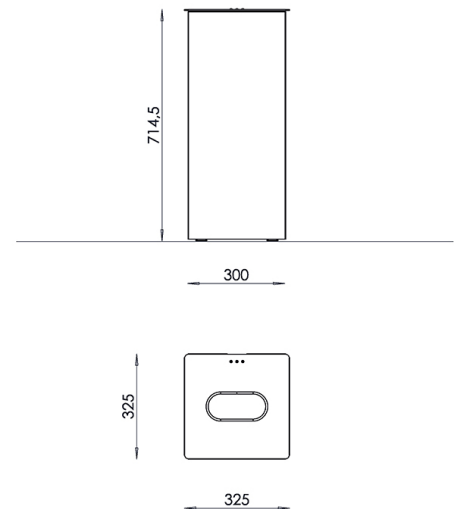

Dimensions (version with feet):
 H=714,5 mm, L=325 mm, D=300 mm
 Litter bin capacity: 60 lt
 Weight: approx. 9 kg

Materials, Finishes & Options