



FLOWCHEM

- ▶ Protect aggressive environments subject to chemical, thermal or mechanical attack with Flowcrete's range of low shrink vinyl ester resin lining and coating systems.

Superior Protection against Chemical Attack

Exposure to concentrated acids, alkalis, aggressive solvents and extreme heat can lead to severe degradation of the floor and wall coverings in any chemical processing environment, as well as metal walkways and structures and tank linings.

Flowcrete's unique shrinkage compensated Flowchem range has been engineered to support the toughest of environments, offering first class resistance to most corrosive agents and delivering exceptional protection against their potentially irreparable damage. All systems are fast cure systems, providing a thermal shock resistant finish to ensure a reliable and easily maintained finish.

What's more, with insulation, isolation and electrostatic performance benefits, the Flowchem range delivers the ultimate in antistatic corrosion protection to take on the chemical processing industries.

Transforming Chemical Processing Environments

Offering total protection against corrosive agents and chemical attack, Flowchem systems can support even the toughest of facilities in a range of applications.



Weather resistant protection



Chemical processing plants



Metal structure coatings

Performance Benefits

✓	Exceptional chemical resistance*
✓	Shrinkage compensated to reduce stress
✓	Withstands temperatures up to 185°C
✓	Coatings can be applied to a range of substrates
✓	Vertical systems available for tanks and silos
✓	Abrasion and impact resistant
✓	Withstands thermal shock
✓	Antistatic grades available to protect against shock
✓	UV resistant
✓	Fast cure systems minimise downtime

* A detailed chemical resistance chart is available upon request for all Flowchem VE systems. Please contact your local Technical Department for further assistance.



Technical Specifications

PRODUCT SELECTOR

How to choose the optimum product for your application:

- 1 Select your intended area of application.
- 2 Identify your possible system options.
- 3 Make your final selection using the ratings given.

SYSTEM PERFORMANCE GUIDE

The table shows how well the system complies with different performance characteristics using a scale from 1 to 5.

- 5 Excellent 4 Very Good 3 Good (pass) 2 Fair 1 Poor

System Options	Flowchem VE Roller Coat	RC Composite	Flowchem VE Spray Coat	Flowchem VE Self Levelling	Flowchem VE Glass Lining	Flowchem VE Honeycomb	Flowchem VE HD V - 5mm	Flowchem VE HD H - 5mm	Flowchem VE HD H - 10mm	Flowchem VE HD H - 15mm
AREAS OF APPLICATION	COATINGS			LININGS			FLOOR SCREEDS AND RENDERS			
Secondary Containment Bunds				✓	✓	✓	✓	✓	✓	✓
Storage and Warehousing	✓	✓		✓	✓		✓	✓	✓	✓
Waste Water Treatment			✓M		✓	✓				
Metal Tank Linings	✓M		✓M		✓M					
Liquid Processing		✓		✓	✓		✓	✓	✓	
Dry Powder Processing	✓			✓			✓	✓	✓	
Solvent Handling and Storage	✓	✓		✓	✓		✓		✓	✓
Explosion Risk (♦)	✓♦	✓♦			✓♦	✓♦	✓♦	✓♦	✓♦	✓♦
Plant and Battery Rooms	✓	✓	✓M	✓	✓		✓	✓	✓	
Clean Room Laboratories	✓	✓		✓			✓	✓		
Liquid Nitrogen Handling					✓		✓			
Tanker Handling Bays					✓		✓			✓
Flue Gas Desulphurisation Process					✓	✓	✓		✓	
PERFORMANCE CRITERIA										
Fire Safety	5	5	5	5	5	n/a	5	5	5	5
Slip Resistance	3	5	3	4	2/3	n/a	4	4	4	4
Impact Resistance	2	3	3	4	5	3/4	5	4	5	5
Thermal Resistance	5	5	5	5	5	5	5	5	5	5
Heavy Traffic	3	4	3	4	4	2/3	4	4	5	5
Impermeability	5	5	5	5	5	n/a	5	5	5	5
Wear Resistance	3	3	5	5	5	n/a	5	5	5	5
Chemical Resistance	5	5	5	5	5	5	5	5	5	5
Scratch Resistance	4	4	5	4	4	n/a	5	5	5	5
Cleanability	5	3	5	4	5	n/a	4	4	4	4
ESD Systems Available	♦	♦	n/a	n/a	♦	♦	♦	♦	♦	♦

♦ ESD Systems Available M Metal Substrate System

Chemical Base of System	Cement Based	Epoxy Resin	Polyurethane Resin	Vinyl Ester Resin
CHEMICAL CONDITIONS (Spillage)				
Acetic Acid - 30% at 20°C			✓	✓
Acetic Acid (glacial) - 100% at 40°C				✓
Citric Acid - 30% at 20°C		✓	✓	✓
Citric Acid - 100% at 100°C				✓
Hydrochloric Acid - 10% at 20°C			✓	✓
Hydrochloric Acid - 37% at 80°C				✓
Lactic Acid - 10% at 20°C		✓	✓	✓
Lactic Acid - 100% at 100°C				✓
Nitric Acid - 10% at 20°C			✓	✓
Nitric Acid - 50% at 20°C				✓
Sodium Hydroxide - 50% at 20°C	✓	✓	✓	✓
Sodium Hydroxide - 50% at 80°C				✓
Sulphuric Acid - 20% at 20°C		✓	✓	✓
Sulphuric Acid - 95% at 20°C				✓
Ethanol, Butanol and Methanol	✓		✓	✓
Sugars		✓	✓	✓
CHEMICAL CONDITIONS (Spillage)				
Steam Cleaning	✓		✓ (9mm)	✓
Maximum Temperature	200°C plus	60°C	110°C (9mm)	145 - 185°C
Ultimate Compressive Strength (Mpa)	50	60	70	120+



Superior Chemical Resistance

Flowchem's impressive performance benefits make the range suitable for application in a range of environments.

✓	Chemical processing
✓	Chemical storage
✓	Tank linings
✓	Wastewater treatment
✓	Plant rooms
✓	Outdoor walkways
✓	Concrete and metal structures



Standard Colours

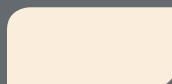

Cream
(close to RAL 9001)

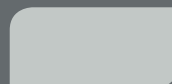

Light Grey
(close to RAL 7035)



Green
(close to RAL 6002)



Dark Grey
(close to RAL 7046)

The applied colours may differ from the examples shown.
For a full colour chart and samples, contact your local
Flowcrete office.



Flowchem VE RC (0.5–1 mm)

A roller coat shrinkage compensated vinyl ester resin based coating system with excellent chemical and mechanical resistance.

For protection of concrete walls, floors, kerbs, equipment bases, trenches and drains against aggressive chemicals, solvents and heavy duty mechanical plus thermal attack.



Thermal resistance:

Can withstand temperatures up to 145°C.



Chemical Resistant:

Protects against the majority of acids used in manufacturing processes.



Abrasion Resistant:

Extreme resistance against impact and heavy-duty traffic.



Fast Curing:

Minimises downtime for less interruption to industry.



UV Resistant:

UV light resistant grade is available. Prevents from yellowing effect.



Technical Profile

TEMPERATURE RESISTANCE	
ASTM D 648-56	Tolerant up to 145°C
SLIP RESISTANCE	
BS 7976-2	Dry >40 Low slip potential Wet: tailored profile
BARCOL HARDNESS	
ASTM 2583	>40
E-MODULUS	
ASTM D 695	3100 N/mm ²
FIRE RESISTANCE	
EN 13501-1	B _{FL} -s1
ABRASION RESISTANCE	
BS 8204-2 BS EN 13892-4	Special
FLEXURAL STRENGTH	
ASTM D 790	125 N/mm ²
TENSILE STRENGTH	
ASTM D 790	73 N/mm ²
ADHESION	
> 4 MPa (Note: substrate failure)	
DENSITY	
1.07	

SPEED OF CURE	20°C
Light Traffic	12 hours
Full Traffic	24 hours
Full Chemical Cure	72 hours

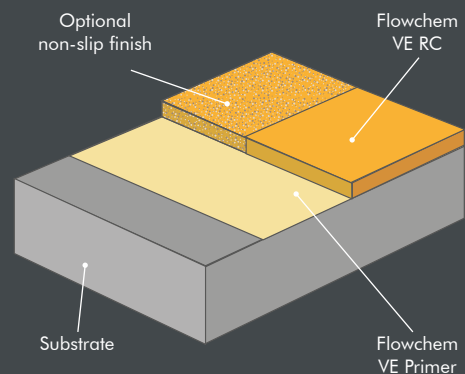

Flowchem VE SC (0.5–1 mm)

A versatile spray applied shrinkage compensated vinyl ester resin based coating system with outstanding all round resistance properties.

For the protection of concrete and metal structures subject to continuous or occasional exposure to heavy duty chemical, thermal and mechanical attack.



Thermal resistance:

Can withstand temperatures up to 145°C.



Chemical Resistant:

Protects against the majority of acids used in manufacturing processes.



Fast Application:

Spray applied for fast application on irregular surfaces.



Fast Curing:

Minimises downtime for less interruption to industry.



UV Resistant:

UV light resistant grade is available. Prevents from yellowing effect.



Technical Profile

TEMPERATURE RESISTANCE	
ASTM D 648-56	Tolerant up to 145°C
SLIP RESISTANCE	
BS 7976-2	Dry >40 Low slip potential
BARCOL HARDNESS	
ASTM 2583	>40
E-MODULUS	
ASTM D 695	3100 N/mm ²
FIRE RESISTANCE	
EN 13501-1	B _{FL} -s1
ABRASION RESISTANCE	
BS 8204-2 BS EN 13892-4	Special
FLEXURAL STRENGTH	
ASTM D 790	125 N/mm ²
TENSILE STRENGTH	
ASTM D 638	73 N/mm ²
ADHESION	
>4 MPa (Note:substrate failure)	
DENSITY	
1.7	

SPEED OF CURE	20°C
Light Traffic	12 hours
Full Traffic	24 hours
Full Chemical Cure	72 hours

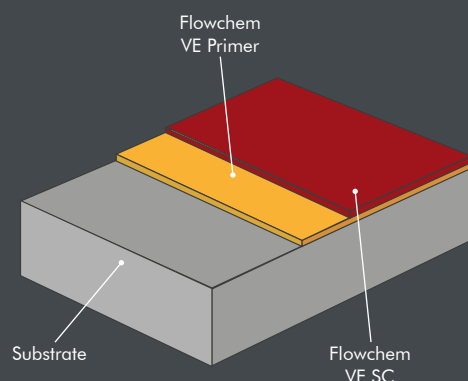

Standard Colours

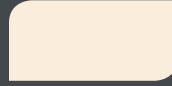

Cream
(close to RAL 9001)

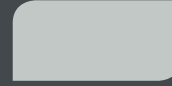

Light Grey
(close to RAL 7035)



Green
(close to RAL 6002)



Dark Grey
(close to RAL 7046)

The applied colours may differ from the examples shown.
For a full colour chart and samples, contact your local
Flowcrete office.

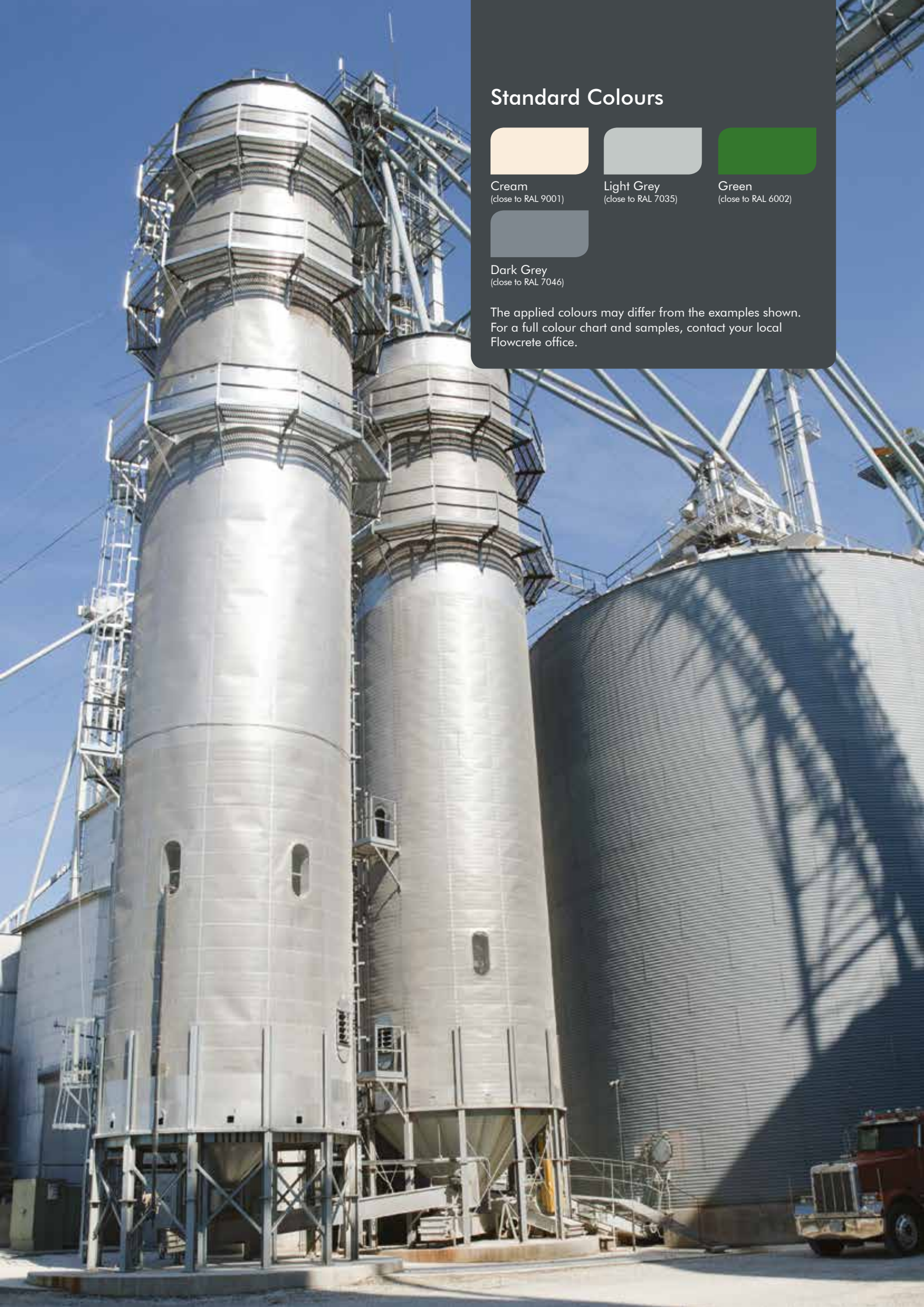

Technical Profile

TEMPERATURE RESISTANCE	
ASTM 648.56	145°C max
SLIP RESISTANCE	
BS 7976-2	Dry >40 Low slip potential
COMPRESSIVE STRENGTH	
ASTM D 695	120 N/mm ²
BARCOL HARDNESS	
ASTM D 2583	>40
E-MODULUS	
ASTM D 695	3100 N/mm ²
FIRE RESISTANCE	
EN 13501-1	B _{FL} -s1
ABRASION RESISTANCE	
BS 8204-2 BS EN 13892-4	Special

Flowchem VE SL (3 mm)

A horizontal self smoothing shrinkage compensated vinyl ester resin based floor screed system with excellent resistance properties.

For protection of concrete floors and bunds against aggressive chemicals, solvents and thermal attack in medium to heavy duty areas.



Thermal resistance up to 145°C



Excellent chemical resistance



Abrasion and impact resistant



Fast curing for minimum downtime

Standard SL Colours



Cream
(close to RAL 9001)

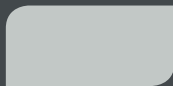

Light Grey
(close to RAL 7035)



Green
(close to RAL 6002)

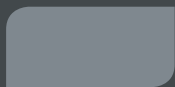

Dark Grey
(close to RAL 7046)

The applied colours may differ from the examples shown. For a full colour chart and samples, contact your local Flowcrete office.

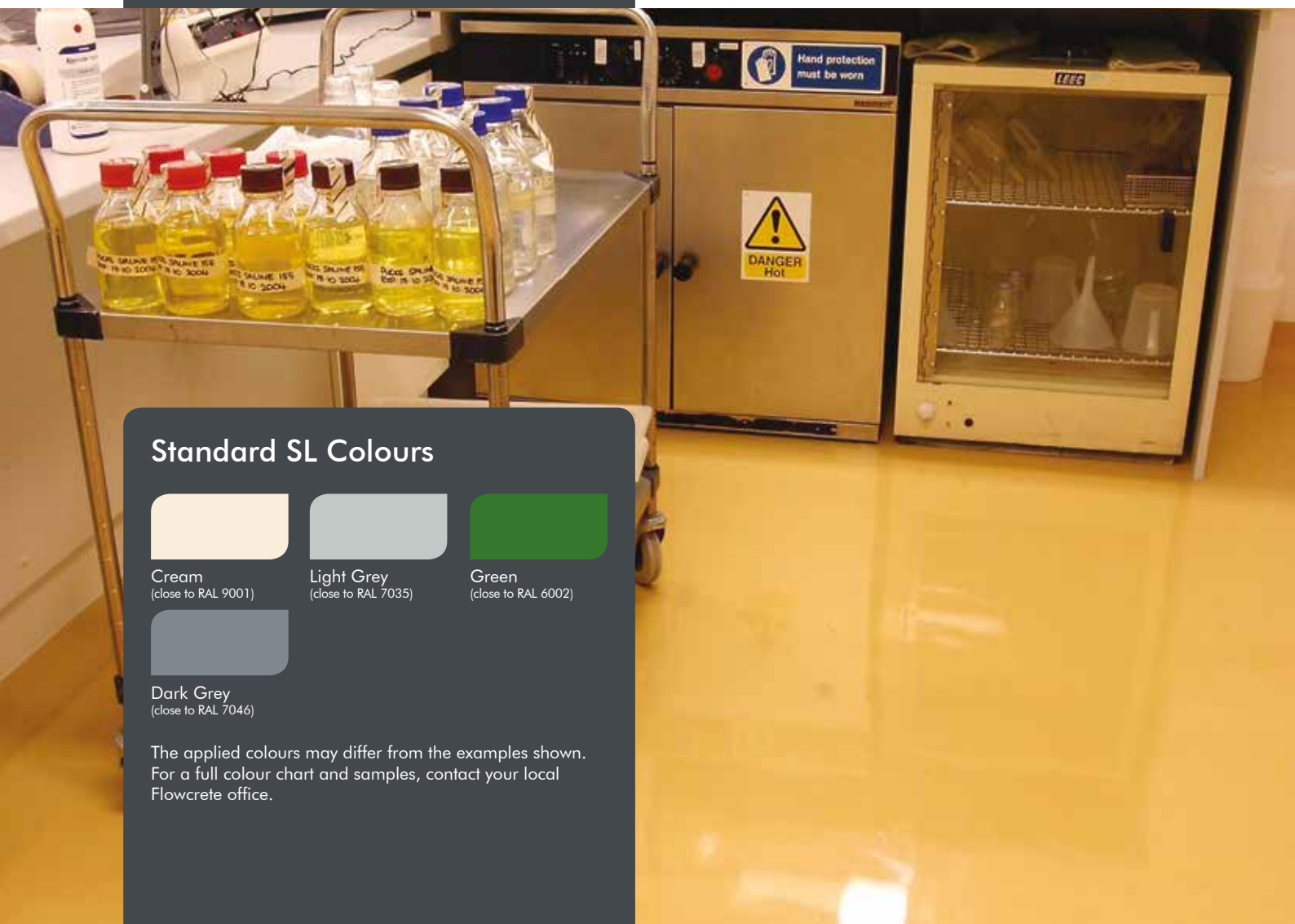

Standard GL Colours

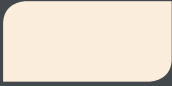

Cream
(close to RAL 9001)

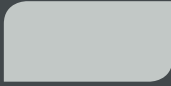

Light Grey
(close to RAL 7035)



Green
(close to RAL 6002)



Dark Grey
(close to RAL 7046)

The applied colours may differ from the examples shown. For a full colour chart and samples, contact your local Flowcrete office.



Technical Profile

TEMPERATURE RESISTANCE

Tolerant up to 165°C

SLIP RESISTANCE

BS 7976-2

Dry >40
Low slip potential
Wet: tailored profile

COMPRESSIVE STRENGTH

ASTM D-695

160 N/mm²

BARCOL HARDNESS

ASTM 2583

>50

E-MODULUS

ASTM D-695

3100 N/mm²

FIRE RESISTANCE

EN 13501-1

B_{FL}-s1

ABRASION RESISTANCE

BS 8204-2
BS EN 13892-4

Special

Flowchem VE GL (2–3 mm)

Shrinkage compensated vinyl ester resin based glass fibre reinforced lining system with high resistance properties.

Designed for the protection of concrete and metal structures from chemical, thermal and mechanical attack.



Thermal resistance up to 165°C



High abrasion and chemical resistance



Fast curing for minimum downtime



UV resistant



Technical Profile

TEMPERATURE RESISTANCE	
ASTM 648.56	Tolerant up to 160°C
SLIP RESISTANCE	
BS 7976-2	Dry >40 Low slip potential
COMPRESSIVE STRENGTH	
ASTM D 695	120 N/mm ²
BARCOL HARDNESS	
ASTM D 2483	>40
E-MODULUS	
ASTM D 695	24000 N/mm ²
FIRE RESISTANCE	
EN 13501-1	B _{FL} -s1
ABRASION RESISTANCE	
BS 8204-2 BS EN 13892-4	Special
FLEXURAL STRENGTH	
ASTM D 790	42 N/mm ²
TENSILE STRENGTH	
ASTM D 638	23 N/mm ²

SPEED OF CURE	20 °C
Light Traffic	12 hours
Full Traffic	24 hours
Full Chemical Cure	72 hours

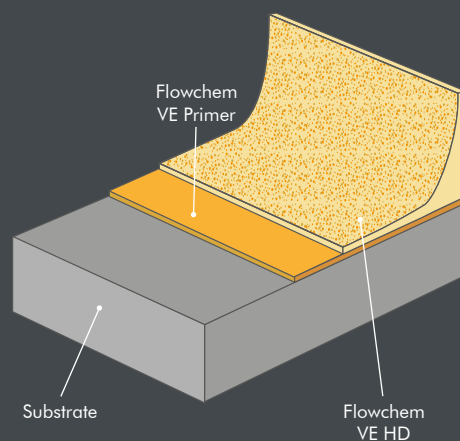

Flowchem VE HD (5–15 mm)

A horizontal (5–15mm) and vertical (5mm) trowel applied vinyl ester resin based screed system with chemical and mechanical resistance.

Protects concrete floors, walls and bunds against aggressive chemicals, solvents and thermal attack.



Thermal resistance:

Can withstand temperatures up to 160°C.



Chemical Resistant:

Protects against the majority of acids used in manufacturing processes.



Abrasion Resistant:

Holds its own against impact and heavy duty traffic.



Resistant:

Excellent resistance to scratches, tainting and dust.



Fast Curing:

Minimises downtime for less interruption to industry.



Technical Profile (Honeycomb C Board)

TEMPERATURE RESISTANCE

Softening point 125°C

COMPRESSIVE STRENGTH

ISO 844 1.3 N/mm²

E MODULUS

ISO 844 15 N/mm²

TENSILE STRENGTH (PERPENDICULAR)

NFT 56130 0.5 N/mm²

DENSITY

80kg/m²

SHEAR STRENGTH

ISO 1922 0.5 N/mm²

SHEAR MODULUS

8 N/mm²

ELECTRICAL CONDUCTANCE

3.5 Kilohms/cm²

Flowchem VE Honeycomb (10 mm)

An insulating honeycombed board with conductive fabric faces, used with the Flowchem VE GL resin lining.

This range provides resistance to continuous or occasional exposure from heavy duty chemical, thermal and mechanical attack.



Thermal resistance up to 145°C



Excellent chemical resistance



Abrasion and impact resistant



Fast curing for minimum downtime



Technical Profile

ELECTRICAL RESISTANCE	
EN IEC 61340-5-1	$5 \times 10^4 - 1 \times 10^9 \Omega$
TEMPERATURE RESISTANCE	
ASTM D 648-56	Tolerant up to 145°C
SLIP RESISTANCE	
BS 7976-2	Dry >40 Low slip potential
BARCOL HARDNESS	
ASTM 2583	>40
E-MODULUS	
ASTM D 695	3100 N/mm ²
FIRE RESISTANCE	
EN 13501-1	B _{FL} -s1
ABRASION RESISTANCE	
BS 8204-2 BS EN 13892-4	Special

Flowchem VE ESD RC (0.25 mm)

A rolled coat of shrinkage compensated vinyl ester resin with chemical and mechanical resistance.

Designed for the protection of concrete walls, floors, kerbs, trenches and drains against chemical and thermal attack.



Antistatic



Thermal resistance up to 145°C



Fast curing for minimum downtime



UV resistant

Flowchem VE ESD H (10 mm)

An electrostatic dissipating screed system with outstanding chemical and mechanical resistance.

For the protection of concrete floors and bunds against aggressive chemicals, solvents and thermal attack in medium to heavy duty areas.



Antistatic



Excellent chemical resistance



Thermal resistance up to 185°C



Fast curing for minimum downtime

Technical Profile

ELECTRICAL RESISTANCE	
EN IEC 61340-5-1	$5 \times 10^4 - 1 \times 10^9 \Omega$
TEMPERATURE RESISTANCE	
ASTM 648.56	185°C
SLIP RESISTANCE	
BS 7976-2	Dry >40 Low slip potential
BARCOL HARDNESS	
ASTM D 2583	>40
E-MODULUS	
ASTM D 695	2400 N/mm ²
FIRE RESISTANCE	
EN 13501-1	B _{FL} -s1
ABRASION RESISTANCE	
BS 8204-2 BS EN 13892-4	Special

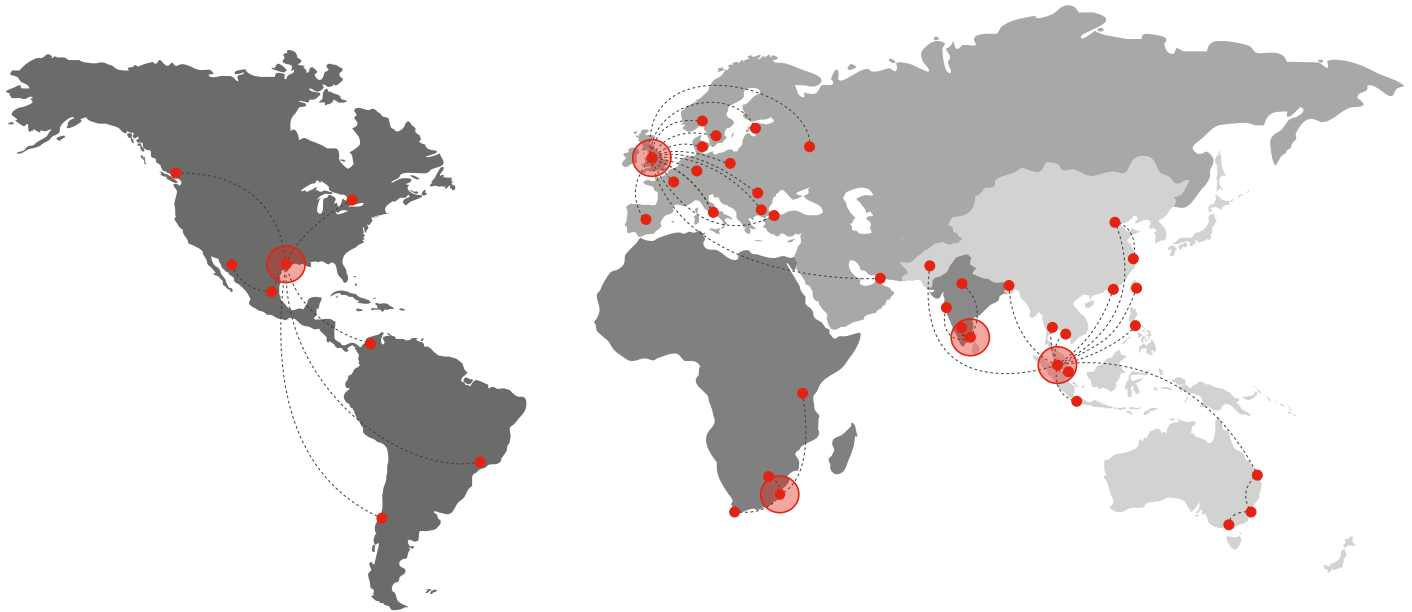

Flowcrete

World leader in seamless resin flooring solutions and other specialist coatings.

Europe & Middle East

Baltic States	+48 883 303 880	latvia@flowcrete.com
Bulgaria	+359 898 61 58 31	bulgaria@flowcrete.com
Denmark	+46 435 40 01 10	denmark@flowcrete.com
France	+33 1 60 61 74 42	france@flowcrete.com
Germany	+49 4187 50 29 470	germany@flowcrete.com
Italy	+39 339 4853258	italy@flowcrete.com
Norway	+47 6486 0830	norway@flowcrete.com
Poland	+48 22 879 8907	poland@flowcrete.com
Romania	+40 766 596 991	romania@flowcrete.com
Russia	+7 916 931 35 13	russia@flowcrete.com
Spain	+34 937 07 0872	spain@flowcrete.com
Sweden	+46 435 40 01 10	sweden@flowcrete.com
Turkey	+90 212 294 6567	turkey@flowcrete.com
UAE	+971 4 886 4728	uae@flowcrete.com
UK	+44 1270 753 000	uk@flowcrete.com

Africa

East Africa	+254 20 682 1011	eastafrica@flowcrete.com
South Africa	+27 31 701 0017	southafrica@flowcrete.com

India

India	+91 44 4017 6600	india@flowcrete.com
-------	------------------	---------------------

Asia Pacific

Australia	+61 7 3205 7115	australia@flowcrete.com
Bangladesh	+88 02 985 7222	bangladesh@flowcrete.com
China	+86 10 8472 1912	china@flowcrete.com
Hong Kong	+852 2795 0478	hongkong@flowcrete.com
Indonesia	+62 21 252 3201	indonesia@flowcrete.com
Malaysia	+60 3 6277 9575	malaysia@flowcrete.com
Pakistan	+92 337 3159272	pakistan@flowcrete.com
Philippines	+63 2 834 6506	philippines@flowcrete.com
Singapore	+65 6848 7166	singapore@flowcrete.com
Taiwan	+886 916 954 291	taiwan@flowcrete.com
Thailand	+66 2539 3424	thailand@flowcrete.com
Vietnam	+84 28 6287 0846	vietnam@flowcrete.com

Americas

Brazil	+55 11 3230 1107	brazil@flowcrete.com
Canada	+1 604 628 1782	canada@flowcrete.com
Chile	+56 2 2938 1962	chile@flowcrete.com
Colombia	+57 1 381 9254	colombia@flowcrete.com
Mexico	+01 800 099 0468	mexico@flowcrete.com
USA	+1 936 539 6700	usa@flowcrete.com

*Whilst every care has been taken to ensure that the information included in this document was accurate at the time of printing, Flowcrete reserves the right to change product specifications at any time without prior notice. The photographs and colours reproduced in this publication are within the constraints of the printing process and are not to be used for matching purposes. All photographs are used for approximate representation only and may not show the actual products on offer. E&OE.