

## ROCKSILK® RAINSCREEN SLAB INSTALLATION GUIDE - MASONRY OUTER LEAF

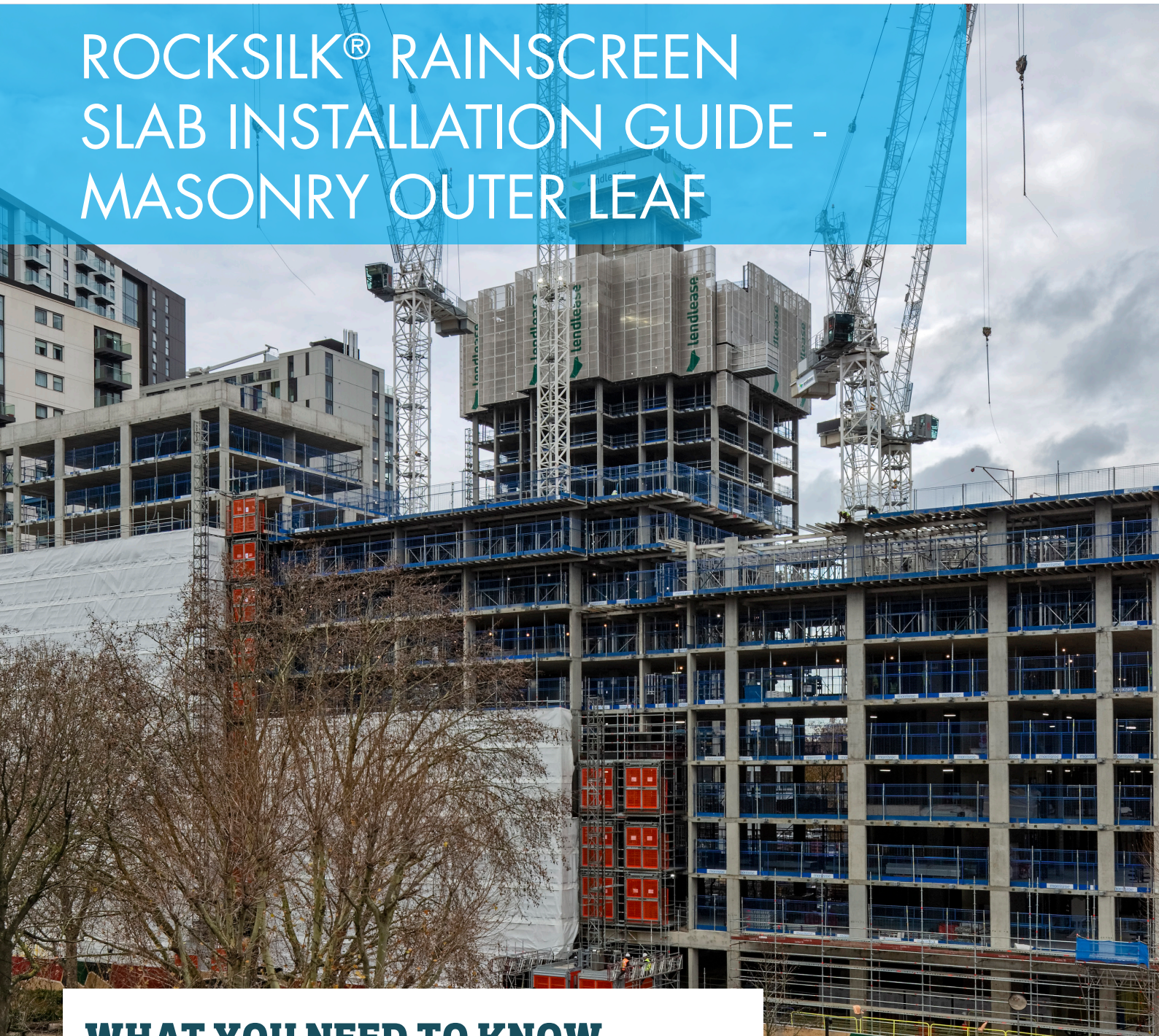

### WHAT YOU NEED TO KNOW

## CONTENTS

	Page
Safety considerations	3
Typical System	4
BBA Certified Solutions	5
Pre-Installation considerations	6
Placement	8
Installation Sequence	13
Cutting	14
Detailing Considerations	15
Fixings	16
Compression Sleeves	18
Maintenance	19
Site Check List	20

# SAFETY CONSIDERATIONS

## STORAGE

Rocksilk® RainScreen Slab should be stored properly and handled in such a way as to ensure that the product remains clean and undamaged.

The shrink-wrapped pallets used for the supply of Rocksilk® RainScreen Slab are designed for short-term protection only. For longer term protection on site, the products should either be stored indoors or under cover and off the ground. Rocksilk® RainScreen Slab should not be left permanently exposed to the elements.

If the main hood is removed or damaged, the remaining packs should be kept under cover indoors or protected from the elements by a weatherproof cover. In coastal locations where weather is more extreme and bird damage is more common, use additional covering or store indoors.

The products must be protected from prolonged exposure to sunlight, and stored dry and flat.

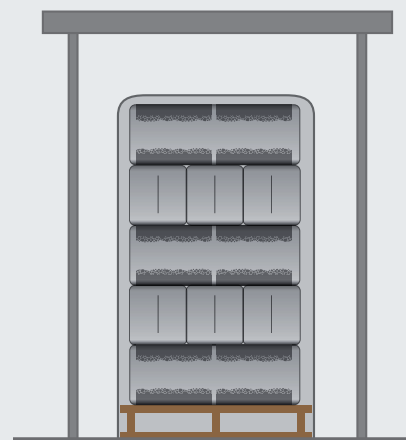

✓ Slabs protected from weathering potential

## HANDLING

Rocksilk® RainScreen Slab is light and easy to handle; care should be exercised to avoid crushing their edges or corners. If damaged, the product should be discarded. Damaged, contaminated or wet product must not be used.

During construction exposed areas of slabs should always be covered at the end of a day's work or in heavy rain. Polyethylene covers should be used to provide protection and prevent work from becoming saturated.

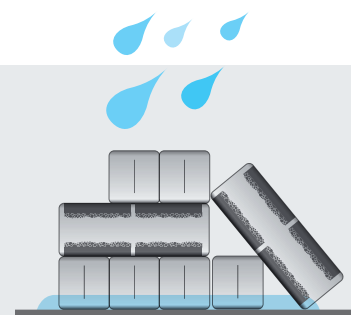

✗ Slabs exposed to the elements

## SAFETY EQUIPMENT AND TOOLS

It is recommended that the following Personal Protective Equipment should be used while handling the product:

**PPE:** Dust mask (FFP1 minimum), gloves, safety glasses

**Tools:** Knife or fine-toothed saw, tape measure

It is recommended that dust masks, gloves and long-sleeved clothing should be worn during cutting and handling of the product.



# TYPICAL PARTIAL-FILL BEHIND MASONRY SYSTEMS

## SYSTEM USING BRICK TIE CHANNELS

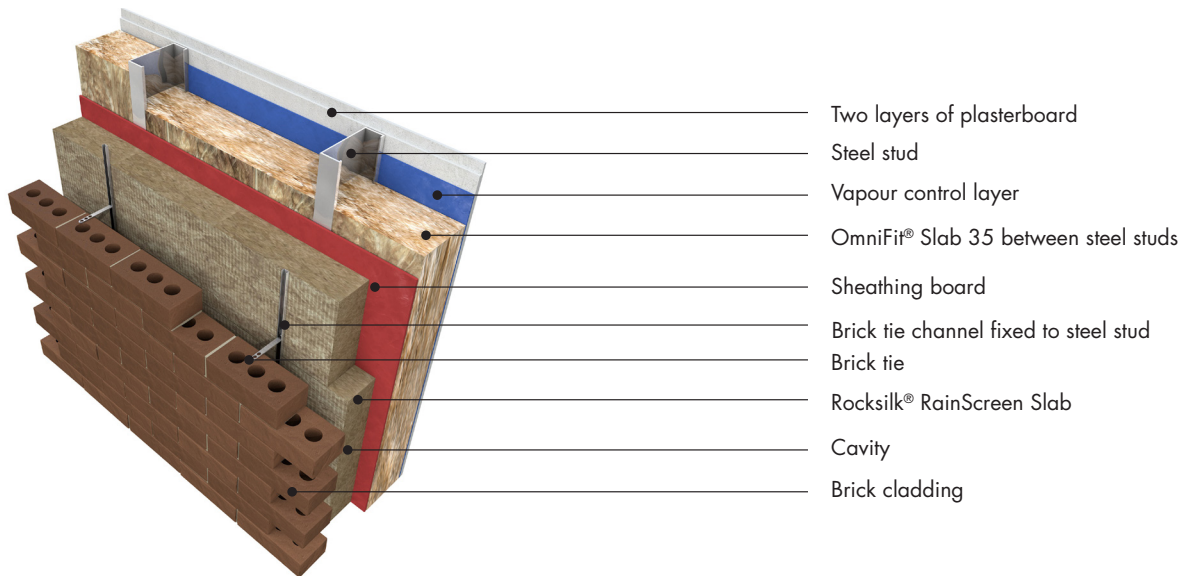

### Note:

- The brick restraint system used shall be suitable for the specific project being considered and fitted in accordance with the instructions and recommendations of the system manufacturer. If brick tie channels are used to retain the Rocksilks® RainScreen Slab to the inner leaf, then they shall be at a maximum of 455mm vertical centres otherwise supplementary insulation fixings must be used.
- The brick tie channels shall be fixed at a distance equal to the design thickness of the Rocksilks® RainScreen Slab and so that it is kept in continuous intimate contact with the sheathing board but not compressed.
- The brick restraint system must be stainless steel as per BS EN 845-1.

## SYSTEM USING BRICK TIES AND RETAINING DISCS

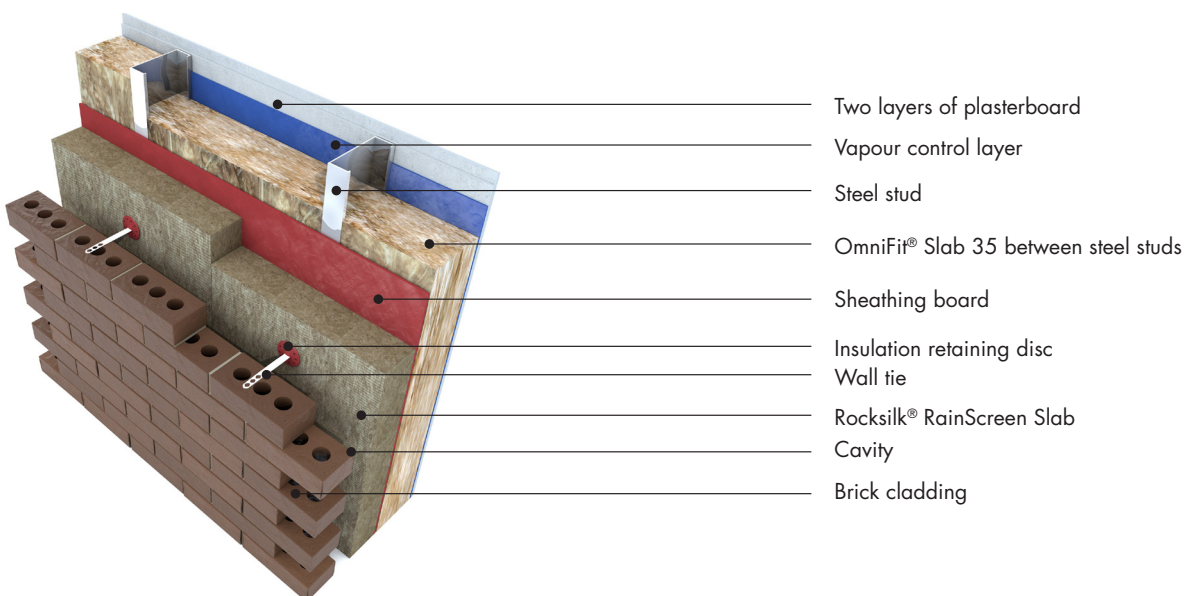

# BBA CERTIFIED SOLUTIONS



TIMBER FRAME  
SINGLE LAYER

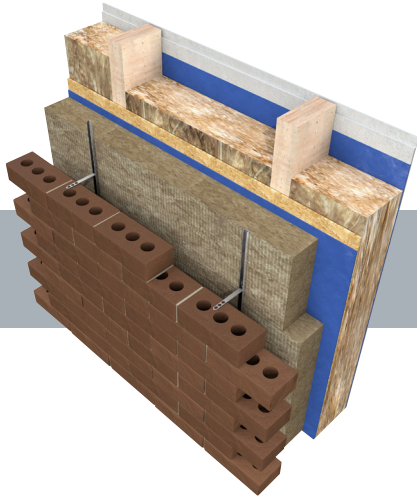

TIMBER FRAME  
DOUBLE LAYER

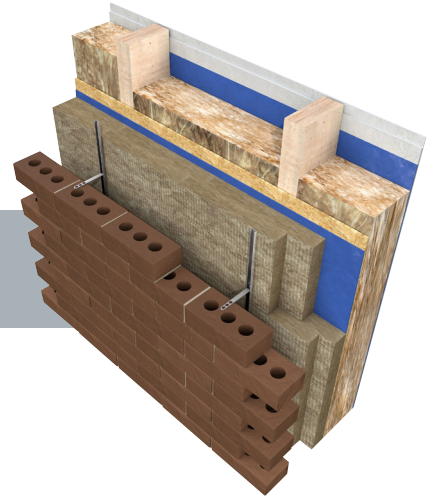

STEEL FRAME  
WITH WALL TIES

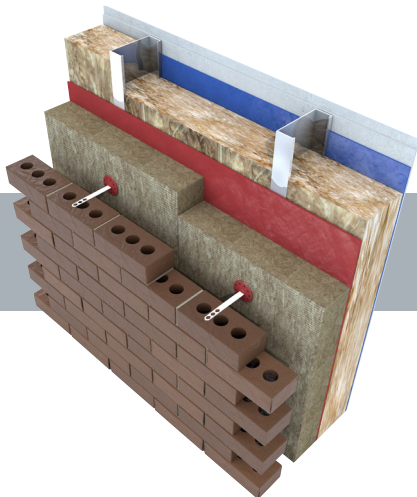

STEEL FRAME  
WITH BRICK  
RESTRAINT SYSTEMS

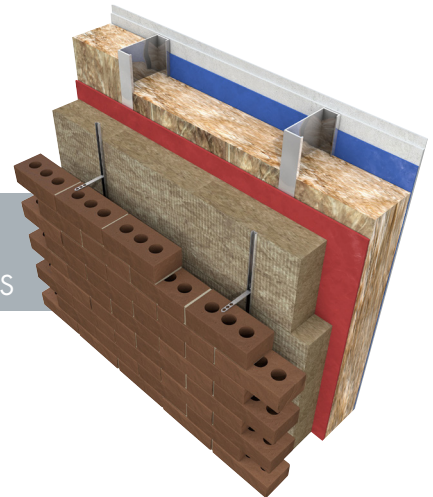

CROSS LAMINATED  
TIMBER

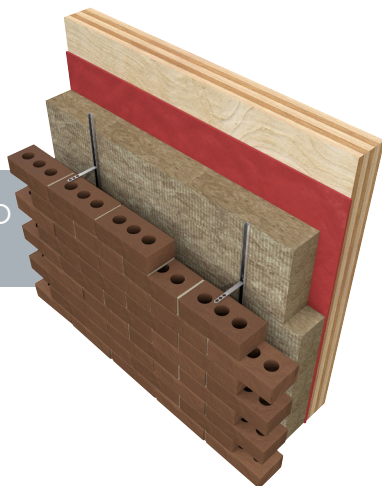

# PRE-INSTALLATION CONSIDERATIONS

## RAINSCREEN MASONRY OUTER DUAL LAYERING USING A SFS OR TIMBER FRAME

### Retaining discs

1. The wall ties should be fixed into studs at 455mm vertical centres
2. The inner layer should be installed in a portrait orientation in line with edges of the slab being in the centre of the SFS or timber studs and between the wall ties
3. Should it be necessary, the first row of slabs can be fixed through the centre of the slabs directly into the sheathing board for additional support
4. The outer layer of RocksilK® RainScreen Slab should be installed in a portrait orientation with the slabs fixed in position using the wall ties and retaining discs
5. In the final assembly, the slabs are held in position by the retaining discs on the wall ties.

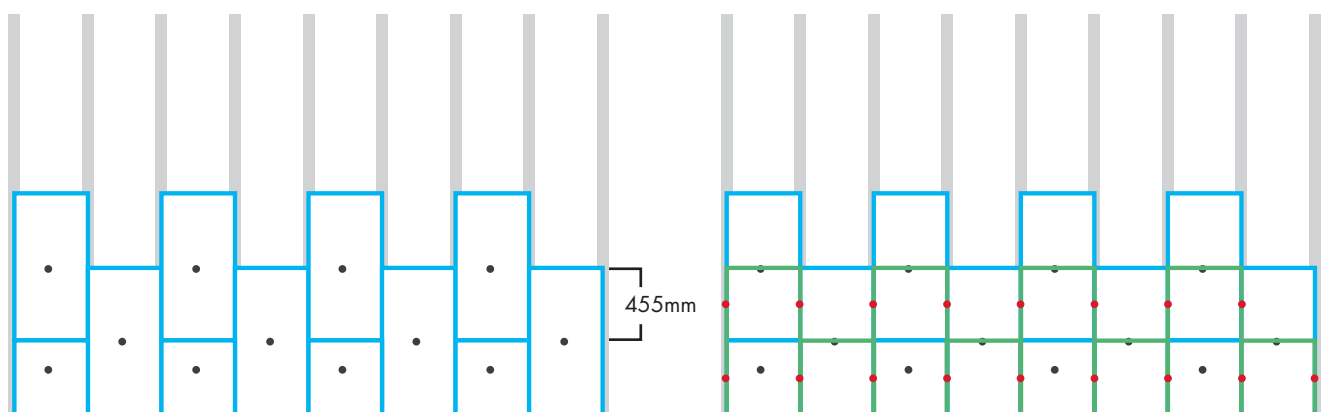

- KEY:
- SFS studs
  - First layer of RocksilK® RainScreen Slab
  - Second layer of RocksilK® RainScreen Slab
  - Fixings
  - Wall ties with retaining discs

# PRE-INSTALLATION CONSIDERATIONS

## RAINSCREEN MASONRY OUTER DUAL LAYERING USING A SFS OR TIMBER FRAME

### Brick tie channels

1. The inner layer should be installed in a landscape orientation with the edges of the slabs staggered from the stud lines
2. Should it be necessary, the first rows of slabs can be fixed with fixings through the centre of the slabs directly into the sheathing board for temporary support
3. The outer layer of Rocksilks® RainScreen Slab should be installed in a landscape orientation staggered by minimum 100mm to the first layer, again with the slab edges not running in line with the SFS or timber stud line
4. Once the first 2 layers have been installed then the brick tie channels can be installed with the fixings fixed directly into the studs. Care should be taken to ensure that each full slab is held firmly in place by a minimum of two brick tie channels
5. Further layers of Rocksilks® RainScreen Slab can then be installed behind the vertical channels in a landscape orientation fixed back to the superstructure using the brick tie channels
6. In the final assembly the slabs are held in position by the brick tie channels
7. When installing dual layers totalling 180mm or above, compression sleeves must be used to firmly fix the brick tie channels back to the sheathing board (see page 8 for more information).

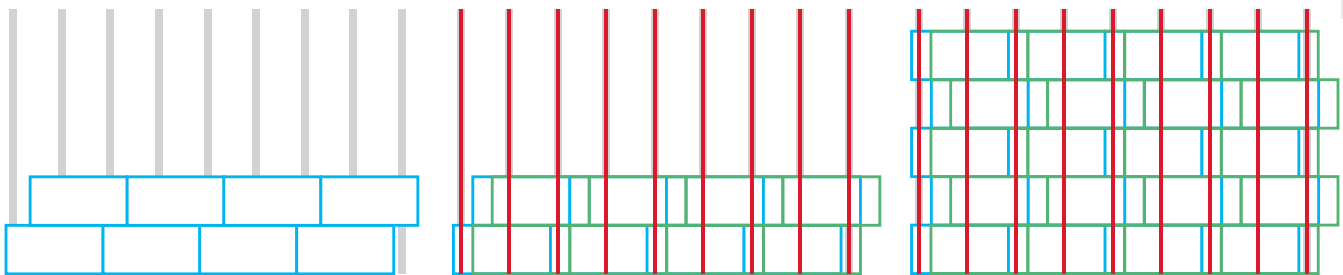

- KEY:
- SFS or timber studs
  - First layer of Rocksilks® RainScreen Slab
  - Second layer of Rocksilks® RainScreen Slab
  - Brick tie channels

# PLACEMENT

## USING BRICK TIE CHANNELS

### JOINTS BETWEEN SLABS SHOULD BE STAGGERED

Joints between slabs should be staggered by a minimum of 100mm and coincidental joints should be avoided.

Slabs should be installed in a landscape orientation.



### To avoid gaps between slabs

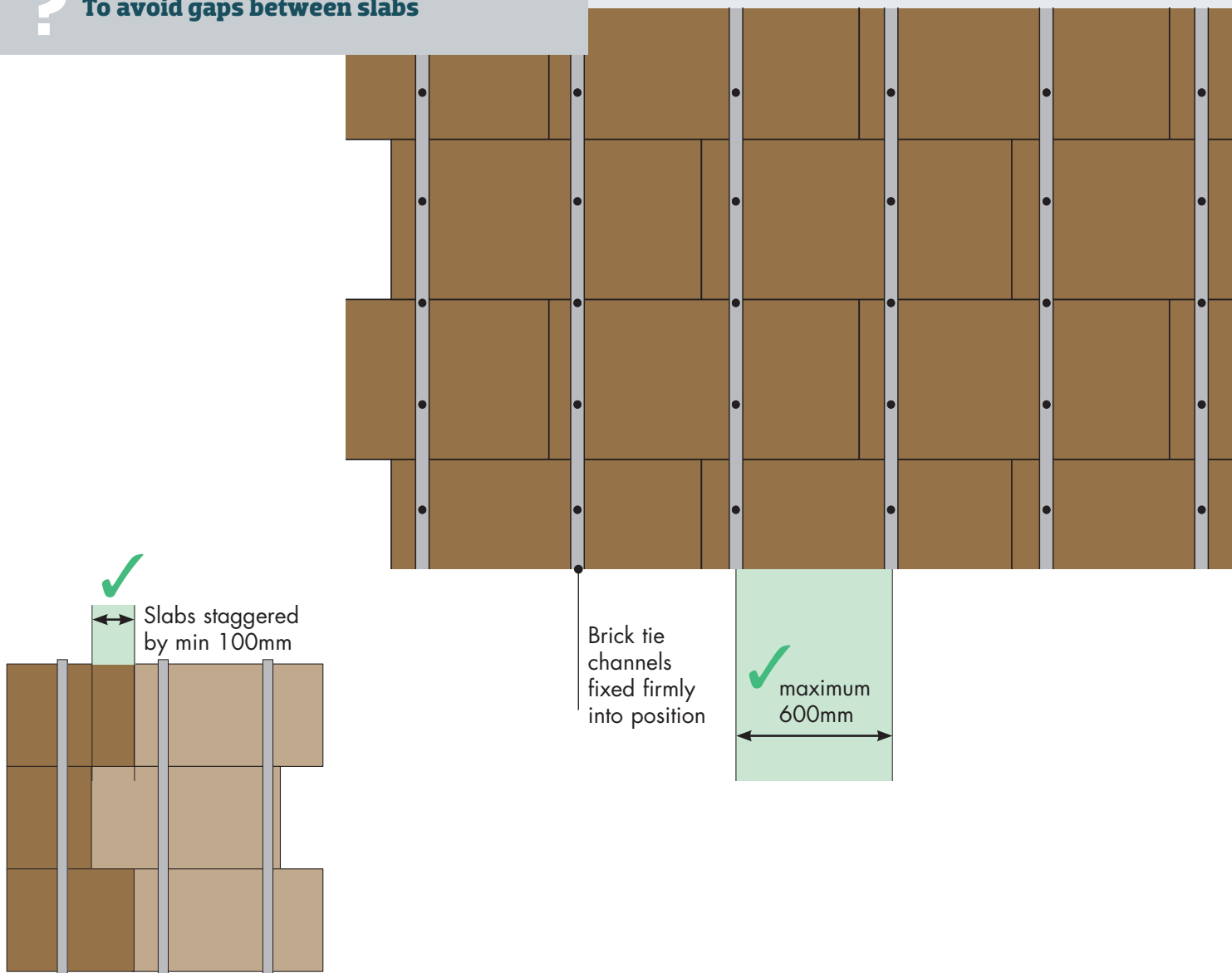



# PLACEMENT

## USING RETAINING DISCS

Discs and wall ties should be fixed along stud lines at maximum 455mm centres to lie within mortar joints and slabs should then be friction fitted between wall ties such that the discs fall between slab joints. Retaining discs are used to retain insulation back to the sheathing board.



Slabs can be installed in either landscape or portrait orientation.

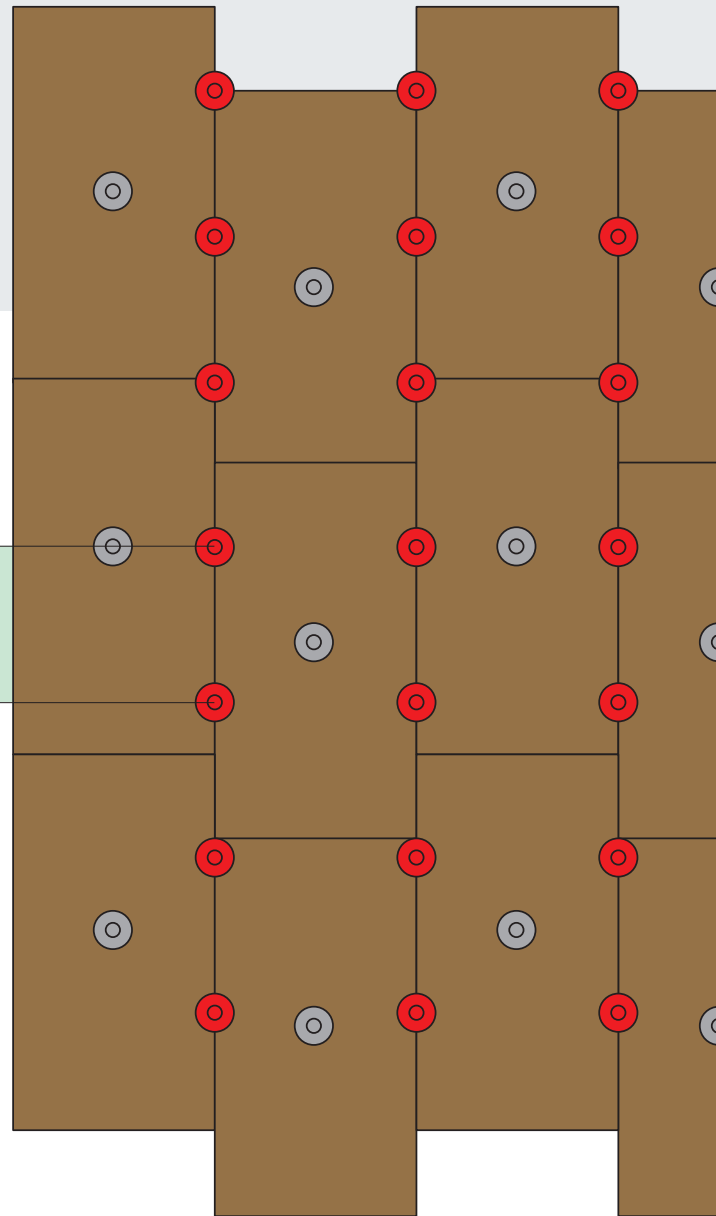
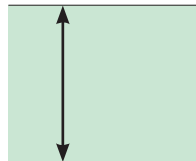

**To ensure a simple to install, strong fit of Rocksilk® RainScreen Slab to sheathing board**

✓ Maximum 455mm



FIXING:  Wall tie and retaining disc  
 Metal washer

# PLACEMENT

## DOUBLE-FACED

IT DOESN'T MATTER WHICH WAY ROUND IT IS INSTALLED

Installed with either face in continuous intimate contact with the substrate without affecting its durability or thermal properties.

## SLABS TO BE IN CONTACT WITH EACH OTHER

Installed such that they are tightly butted together at joints and staggered by minimum 100mm.

**?** To avoid coincidental joints and maintain thermal and acoustic performance

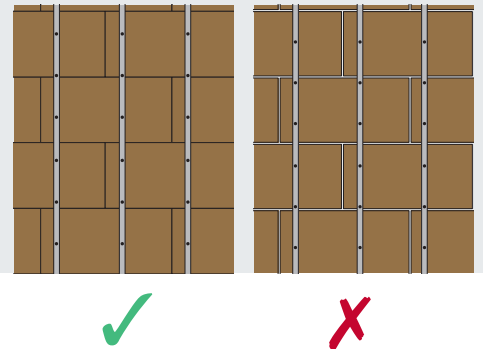

## INTIMATE CONTACT WITH SUBSTRATE

Rocksilk® RainScreen Slab should be in continuous intimate contact with the building substrate. The nature of the insulation material lends itself to accommodate any irregularities in the surface of the substrate.

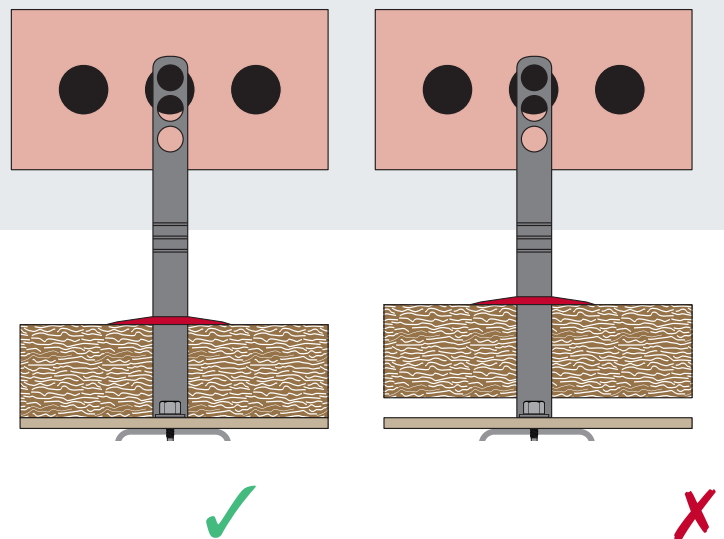

# PLACEMENT

## COMPRESSION FIT INTO PLACE

Rocksilk® RainScreen Slab should be cut slightly oversize and compression fitted into place.

**?** To create a snug fit between slabs, reducing the chance for air gaps and ensuring thermal efficiency.

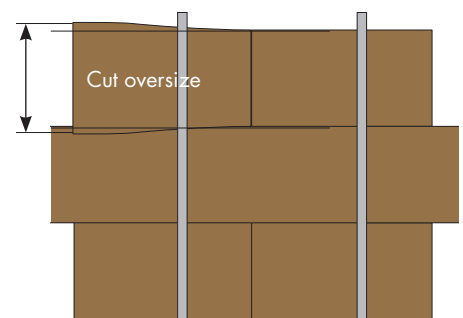
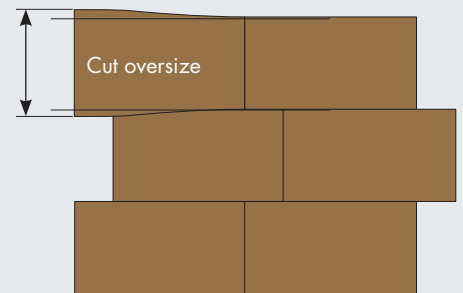

## MAINTAIN A CAVITY

Make sure a cavity remains between the insulation and the external cladding. Approved Document C and NHBC guidance state that the residual cavity should not be less than 50mm wide.

Brick tie channel

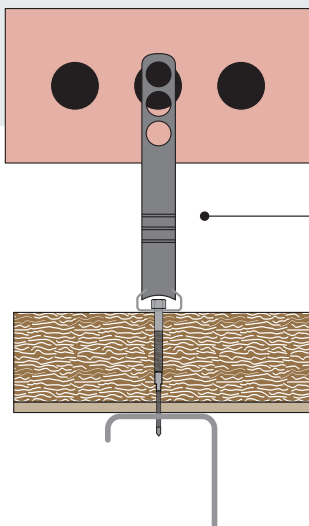

Cavity width of 50mm or above

Retaining disc

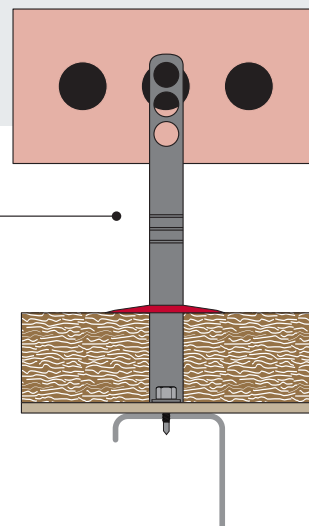

# PLACEMENT

## ROCKSILK® RAINSCREEN SLAB BELOW DPC

Rocksilk® RainScreen Slab does not absorb water by capillary action and may therefore be used in situations where it bridges the DPC's of the inner and outer leaf.

### ? To simplify installation

- Two layers of plasterboard
- Vapour control layer
- Timber stud
- OmniFit® Slab 35
- Breather membrane
- Sheathing board
- Brick tie
- Screw fixed through insulation to timber stud
- Brick tie channel fixed to timber stud
- Rocksilk® RainScreen Slab
- Cavity
- Brick cladding
- SFS sole plate
- Damp proof course
- Damp proof course
- Concrete slab
- Brick tie

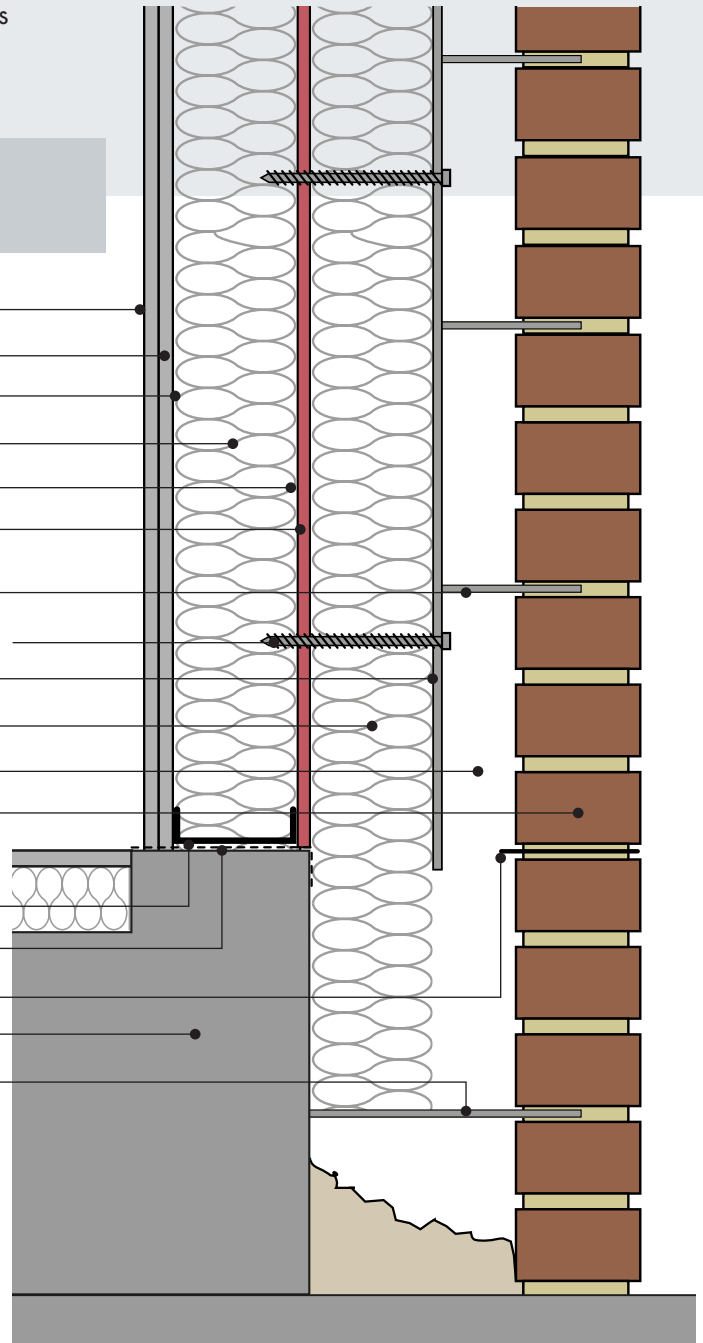

# INSTALLATION SEQUENCE

Place the first layer of Rocksilk® RainScreen Slab in position against the backing structure and temporarily pin in place using an insulation retainer into the sheathing board.

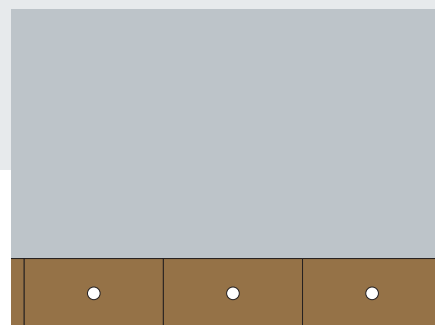

Offer up the brick tie channel e.g. Ancon 25/14 channel or ACS 25/15 Framefix Ultra Channel and fix in position fixings recommended by the manufacturer. Do not fix beyond the 600mm height of the first layer of Rocksilk® RainScreen Slab.

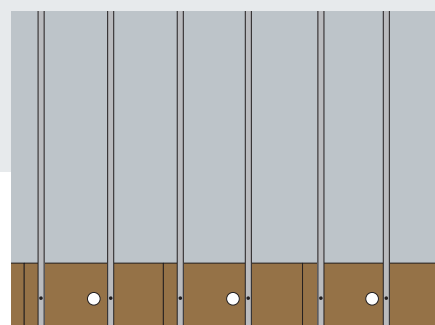

Temporary insulation fasteners can be removed if required.

From above, slide the next row of Rocksilk® RainScreen Slab into place behind the brick tie channel. The slabs will be retained in position by the channel and supported by the row of slabs below.

Fix the channel back to the steel frame using the fixing pattern recommended by the fixing manufacturer e.g. Ancon or ACS, to the height of the next layer of Rocksilk® RainScreen Slab. This procedure should be repeated for every new layer of brick tie channels.

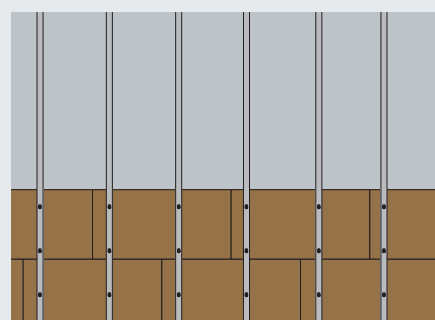

# CUTTING

## CUT NEATLY AROUND PENETRATIONS AND CONSTRUCTION DETAILS - CUT OVERSIZE BY 5MM

Cut neatly around penetrations and construction details using a sharp bladed knife or insulation saw. When cutting around penetrations, cut oversize by 5mm to allow some local compression of the slab around the feature to ensure a snug fit.

? **To maximise thermal performance.**

✓ Leave 5mm overcut

✗ Cut directly up to penetrations

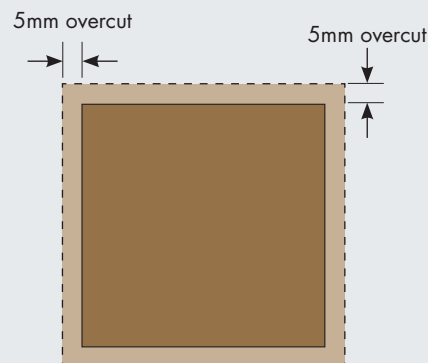

## CUT NEATLY WITH A SHARP INSULATION SAW/KNIFE

Cut neatly with a fine serrated saw or a large bladed knife.

? **Gives a factory quality cut and prevents tearing**

✓ Use insulation saw or knife

✗ Rip using coarse blade



## AREAS THAT CANNOT ACCEPT FULL SLAB SHOULD USE A SLAB SECTION

Areas of insulation that do not require a full slab (aside from corners where a full slab must be used) can be filled using a slab section where the section is cut slightly oversize to give a snug fit and fixed at 600mm intervals in the centre of the section. Each slab section should receive one non-combustible fixing and washer in addition to any other fixings as required to maintain continuity of the insulation.

✓ Slab cut and snug fit

✗ Loose fit for cut slab section

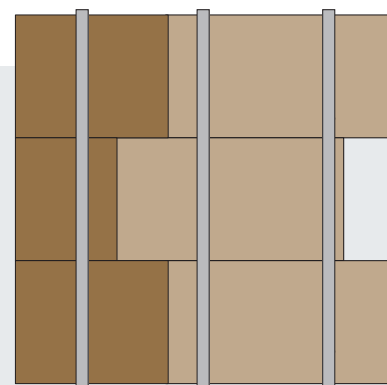

# DETAILING CONSIDERATIONS

## WINDOW DETAILS

Cut slabs to fit neatly around window details. Additional fixings and washers may be required to firmly retain the slabs and ensure continuity of the insulation layer. Fixings should have a minimum of one non-combustible (metal) washer per cut slab in addition to other fixings.

Additional fixings and brick tie channels should be fixed into the border studs or secondary support studs of the penetration detail.

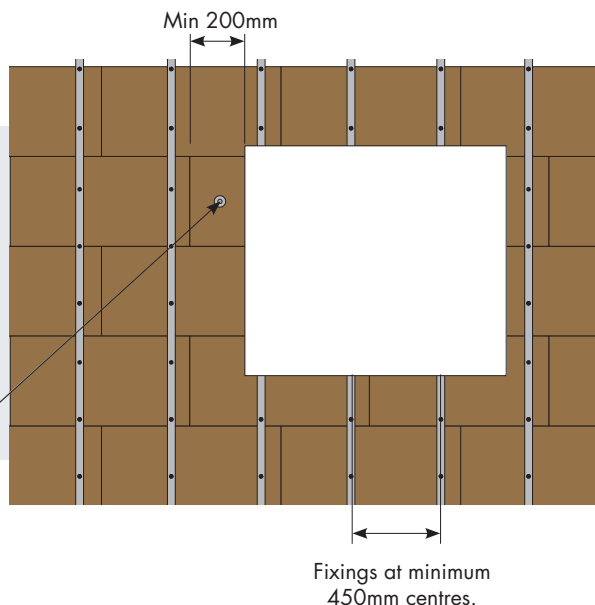

WASHER:  Metal

For small slab sections that cannot take a brick tie channel, metal fixings should be used to hold the slab against the substrate.

## INSTALLATION AROUND SERVICE PENETRATIONS

Product should be offered up to penetration applying sufficient pressure to allow a small indent to be made in the product. An indent should be made on the face that will come into contact with the substrate when the product is installed.

Cut a slot in the product with an insulation saw or large bladed knife. Install the product over the penetration, taking care not to damage the external face of the slab. Ensure that the product is in intimate contact with neighbouring slabs. Secure the slab to the wall substrate with mechanical fixings in accordance with the design specification. Consideration should be made to ensure appropriate fire stopping measures are used around penetrations, especially plastic.



**? Ensures a tight fitment of slabs around penetrations, ensuring maximum thermal efficiency.**

## CAVITY BARRIERS

Cavity barriers should be installed to meet the requirements of *Approved Document B - England and Wales, Handbook Section 2 - Scotland and Technical Booklet E - Northern Ireland*.

# FIXINGS

## FIXINGS AND WASHERS

When installing the first layer of Rocksilk® RainScreen Slab, polypropylene or metal washers should be used to fix the slabs against the sheathing board. This means that the joints between the slabs stay tightly butted ensuring maximum thermal performance.

✓ Fixings used for temporary support if necessary

WASHER:  Polypropylene or metal

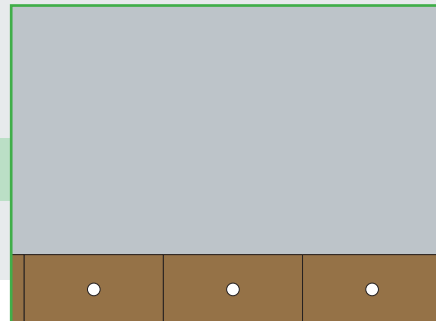

## DON'T OVERTIGHTEN MECHANICAL FIXINGS

Ensure that mechanical fixings are not overtightened, surface compression of the product is not recommended.

? **This compromises the thermal performance and can lead to localised moisture pooling.**

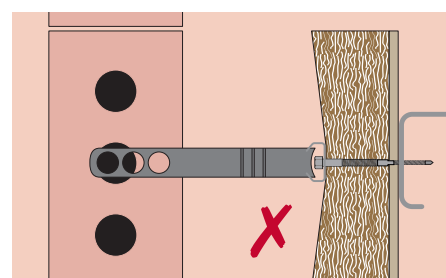
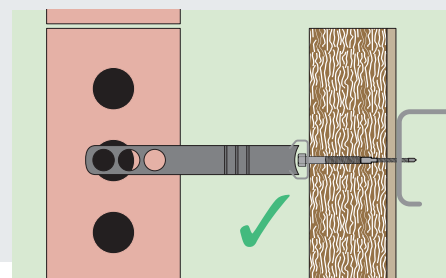



# FIXINGS

## FIXINGS TO USE

Exact fixings will depend on the type of substrate. Suitable Fixing Manufacturers:

Hilti: 0800 886100 Ejot: 01977 687040 Fischer: 01491 827900 Fixfast: 0800 304 7616

Consult fixing manufacturer guidance. A minimum of one non-combustible fixing should be provided for each slab and must be provided in addition to other fixings. Fixings should be corrosion resistant and provide satisfactory in-service performance for the design life of the building.



**Ensure equipment does not damage the product during the fixing process e.g. drill chucks.**

## CORNER DETAILS - ADDITIONAL FIXINGS

Rocksilk® RainScreen Slab should be installed using additional fixings around corner details, where fixings are added to each slab corner such that it is fixed firmly to the super structure.

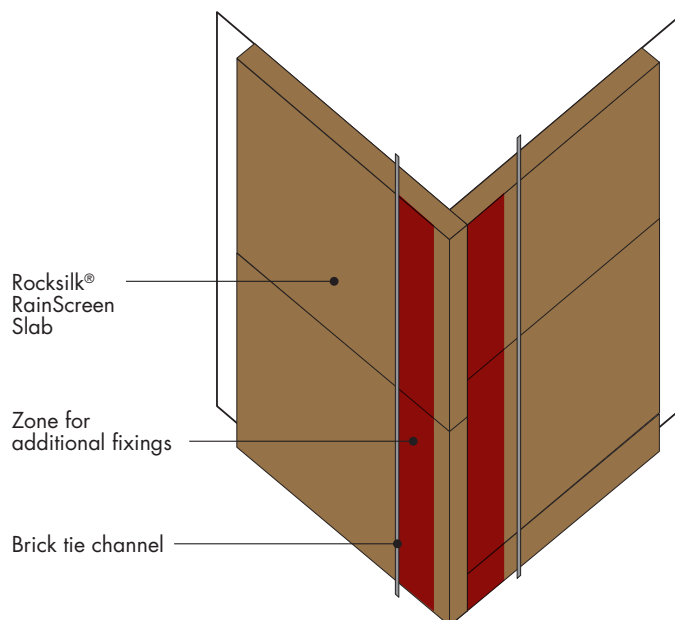

## WASHER MINIMUM DIAMETER OF 70MM

When installing the fixings to retain the insulation, a washer with a minimum diameter of 70mm must be used, to ensure optimum strength of fixing between Rocksilk® RainScreen Slab and substrate.

✓ Washer 70mm or ABOVE

✗ Washer BELOW 70mm

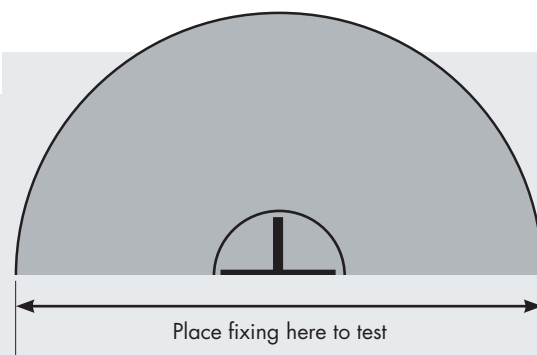

# COMPRESSION SLEEVES

When using Rocksilk® RainScreen Slab up to 180mm with Ancon 25/14 Restraint System, the screws can be installed directly through the insulation. When using greater thicknesses, Ancon recommend Compression Sleeves (the same depth as the insulation) should be used around the fixing screws to provide the necessary support.

When using Rocksilk® RainScreen Slab with ACS 25/15 Framefix Ultra Channel, ACS recommend Compression Sleeves (the same depth as the insulation) should be used around the fixing screws to provide the necessary support irrespective of insulation thickness.

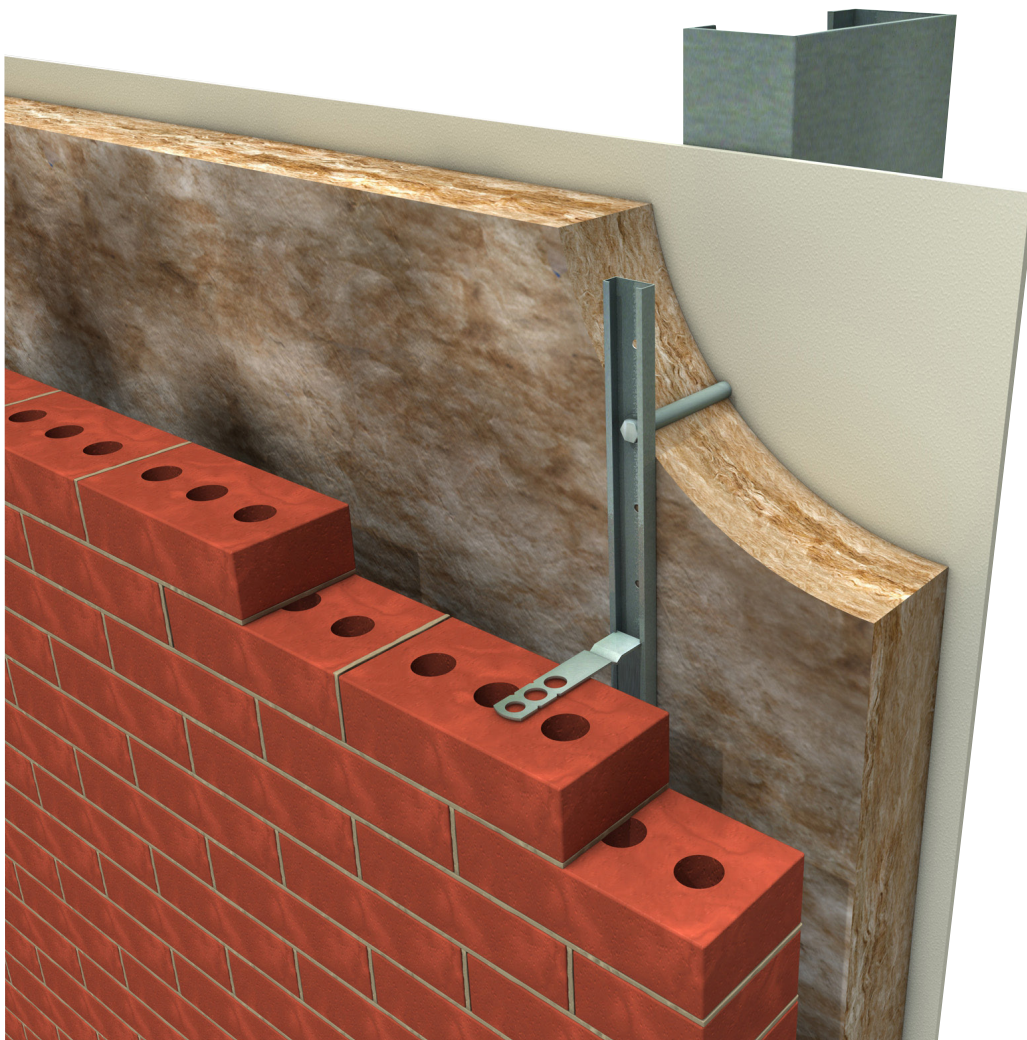

# MAINTENANCE

## ROLLING FRONT - BEST PRACTICE

Rocksilk® RainScreen Slab is designed with a water repellent additive to be weather resistant, however it should be covered up with the outer leaf masonry as work proceeds, on the basis of an advancing front.

✓ Outer leaf masonry installed to reduce weathering.

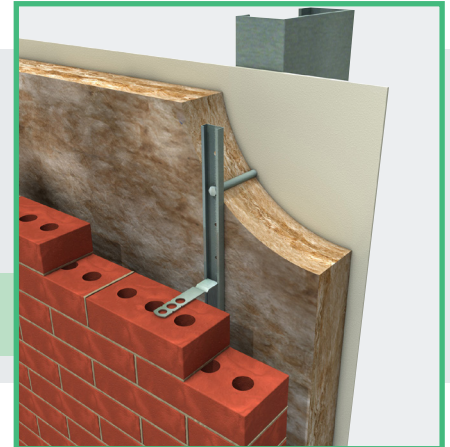

## PARAPET / ROOF LEVEL PROTECTION DURING INSTALLATION

The top edge of the slabs should be covered and any run off water directed away from running down the face of the slabs.

Breather membrane

Rocksilk® RainScreen Slab

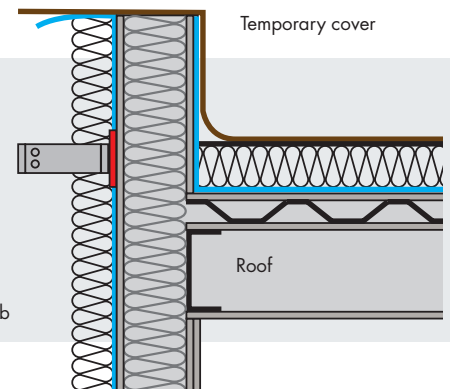

## CONSTRUCTION REPAIRS

In the event of small repairs being needed on site, we recommend the replacement of full slabs wherever possible before installing the brick restraint channels or the insulating retaining clips on the frame cramps.

✓ Full slab replacement after damage      ✗ Small patched repair

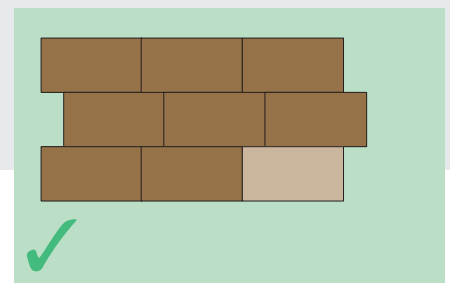
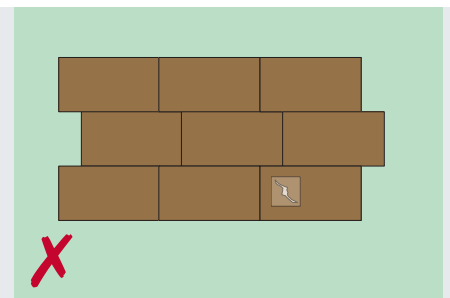

## SITE CHECK LIST ROCKSILK® RAINSCREEN SLAB

System type?	<input type="checkbox"/> Cladding	<input type="checkbox"/> Brickwork
Is the product plain or have a Black Glass Veil facing?	<input type="checkbox"/> Plain	<input type="checkbox"/> BGV
Has the product been stored off-ground and undercover?	<input type="checkbox"/> Yes	<input type="checkbox"/> No
Is there a breather membrane being used in the construction?	<input type="checkbox"/> Yes	<input type="checkbox"/> No
- If yes, is the breather behind or in front of the insulation layer?	<input type="checkbox"/> Behind	<input type="checkbox"/> In front
Does the product being installed appear dry at the time of survey?	<input type="checkbox"/> Yes	<input type="checkbox"/> No
Has a single or double layer* of insulation been used?	<input type="checkbox"/> Yes	<input type="checkbox"/> No
- If double layered, have layers been staggered?	<input type="checkbox"/> Yes	<input type="checkbox"/> No
Has the product been mechanically damaged during installation?	<input type="checkbox"/> Yes	<input type="checkbox"/> No
Have the slabs been installed in "portrait" or "landscape" orientation?	<input type="checkbox"/> Portrait	<input type="checkbox"/> Landscape
Is the primary fixing washer a metal washer?	<input type="checkbox"/> Yes	<input type="checkbox"/> No
Is there a minimum of one metal washer on every slab?	<input type="checkbox"/> Yes	<input type="checkbox"/> No
Are the secondary fixing washers plastic or metal?	<input type="checkbox"/> Plastic	<input type="checkbox"/> Metal
Do washers have a minimum head diameter of 70mm?	<input type="checkbox"/> Yes	<input type="checkbox"/> No
Are all washers fixed so as to be flush with the surface of the slab?	<input type="checkbox"/> Yes	<input type="checkbox"/> No
Have additional fixings & washers been used around windows, corners or other features?	<input type="checkbox"/> Yes	<input type="checkbox"/> No
Are all slabs closely butted together such that there are no visible gaps between them?	<input type="checkbox"/> Yes	<input type="checkbox"/> No
Has the slab been cut to fit neatly over brackets?	<input type="checkbox"/> Yes	<input type="checkbox"/> No
Is the insulation bridged by any component of the construction other than the bracket?	<input type="checkbox"/> Yes	<input type="checkbox"/> No
Is there at least a 50mm residual cavity?	<input type="checkbox"/> Yes	<input type="checkbox"/> No
If installed to parapet level, has the product been protected?	<input type="checkbox"/> Yes	<input type="checkbox"/> No
Have multiple cut pieces been avoided where possible?	<input type="checkbox"/> Yes	<input type="checkbox"/> No
Have slab joints been staggered by at least 100mm?	<input type="checkbox"/> Yes	<input type="checkbox"/> No
What percentage of the installation is exposed to the elements?	<input type="text"/>	
What percentage of the installation of insulation has been completed?	<input type="text"/>	

\*Rocksilk(R) RainScreen Slab BBA certified in single or double layer only.  
This checklist is for on-site install guidance only, and is not a confirmation that Knauf Insulation has inspected or approved install of Rocksilk(R) RainScreen Slab during or after construction.

# KNAUFINSULATION

## CONTACTS

### Specification Team

[knaufinsulation.co.uk/findmyrep](http://knaufinsulation.co.uk/findmyrep)

### Technical Services Team

01744 766 666

[technical.uk@knaufinsulation.com](mailto:technical.uk@knaufinsulation.com)

For more information please visit

[knaufinsulation.co.uk/Rainscreen-solutions](http://knaufinsulation.co.uk/Rainscreen-solutions)



**Knauf Insulation Ltd** PO Box 10, Stafford Road, St.Helens, Merseyside, WA10 3NS. UK

For more information please visit [knaufinsulation.co.uk](http://knaufinsulation.co.uk)

All rights reserved, including those of photomechanical reproduction and storage in electronic media. Extreme caution was observed when putting together and processing the information, text and illustrations in this document. Nevertheless, errors cannot be completely ruled out. The publisher and editors cannot assume legal responsibility or any liability for incorrect information and consequences thereof. The publisher and editors will be grateful for improvement suggestions and details of possible errors pointed out. For the most up-to-date document versions and product information, please always refer to our website.