



The versatile gate for entrances, wide passageways and escape routes

The mSwing swing door is our specialist in versatility! This starts at the entrances: mSwing is used wherever passage is authorised by staff at a gate or reception desk. Either as a single or a double swing door, depending on the number of visitors expected. It is not only the right choice for the monitored access of visitors, but also for visitors with baggage and for those delivering materials. Its wide barrier elements also make it ideal for wheelchair access.

Thanks to the mPost card-reader pillar, operators can also provide passage using card-reading devices. mSwing, however, is particularly important for setting up escape routes. It is always used whenever many people are present in a building at the same time and appropriately wide escape routes are required. With its passageway width of up to 2400 mm as a double door, and automatic opening if there is a power outage or alarm signal, mSwing also ensures safe paths out of the building in emergency situations.



Free escape routes

The swing doors allow free passage in the case of a power outage, and a defined position can be set up for when there is an emergency signal. The barrier elements automatically return to the closed position after removal of the alarm contact or the return of electricity.



Comfortable passage

The smoothly operating motor drive makes the access process particularly comfortable, and its sensitive impact detection ensures maximum user safety.

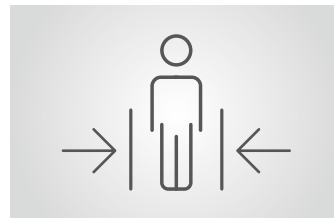

Secure access control

Interlocking in the closed state (optional) prevents any forced entry.

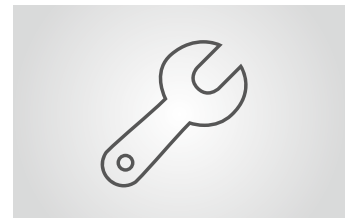

Rapid installation

Our pedestrian gates are supplied ready for installation. All the selected options have already been installed, and the corresponding parameters preset, before delivery to the point of use. This, and the drilling templates, considerably shorten commissioning times.

mSwing



Swing doors





- > As single or double doors for visitor entrances, passage with baggage, transport routes and wheelchair-friendly access
- > For unobstructed escape routes in emergencies
- > Compact accommodation of drive and control systems in the centre column
- > Low impact forces for maximum personal safety
- > Designed for 10,000,000 opening and closing cycles



Technical data	mSwing
Application	Indoor and outdoor
Passage width	Standard: 1000 mm Wide Lane: 1200 mm (more on request)
Barrier element height	Standard: 994 mm (more on request)
Opening/closing time	2,0–5,5 s, depending on barrier element dimensions
Opening angle	Adjustable from 0 – ±300°
Drive technology	MHTM™
Control system	MGC
Voltage	100–240 V AC, 50/60 Hz
Power consumption	Maximum 45 W
Duty cycle	100%
Housing material	Aluminium
Housing height	1092 mm
Housing diameter	Maximum 183 mm
Enclosure rating	IP 54
Weight	About 40 kg (without blocking element)
Temperature range	–30 to +55 °C

Features	
Direction of passage	Uni- or bi-directional
Emergency release	Can be parameterised: fixed position or freely turning
Control system inputs and outputs	8 digital inputs, 4 digital outputs, and 6 relay outputs
Configuration	Via USB interface from external

Standard colours	
	
White aluminium (similar to RAL 9006)	Jet black (similar to RAL 9005)

Potential applications				
				

mSwing – side view

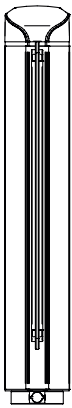

mSwing – front view

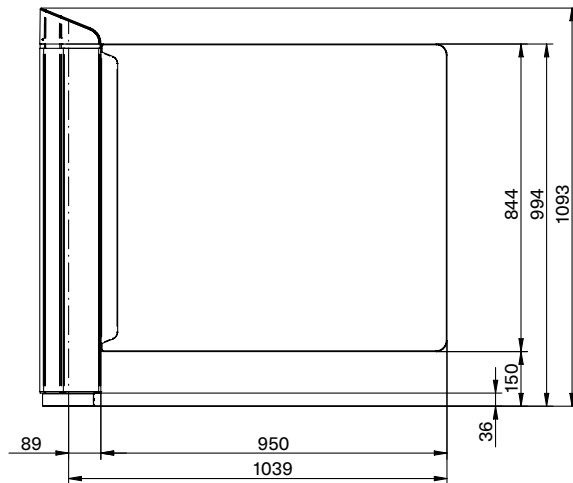

mSwing with U bar – front view

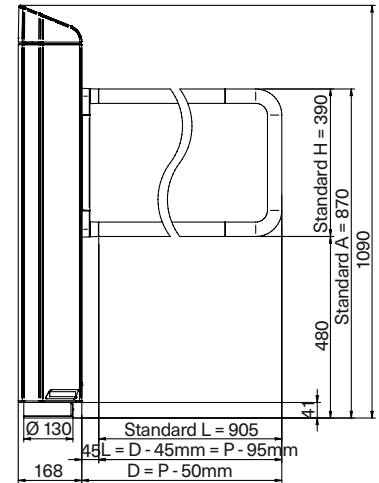

mSwing – top view



mSwing with U bar – top view

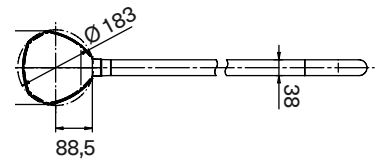

Line configuration with mTripod and mSwing as double swing gate

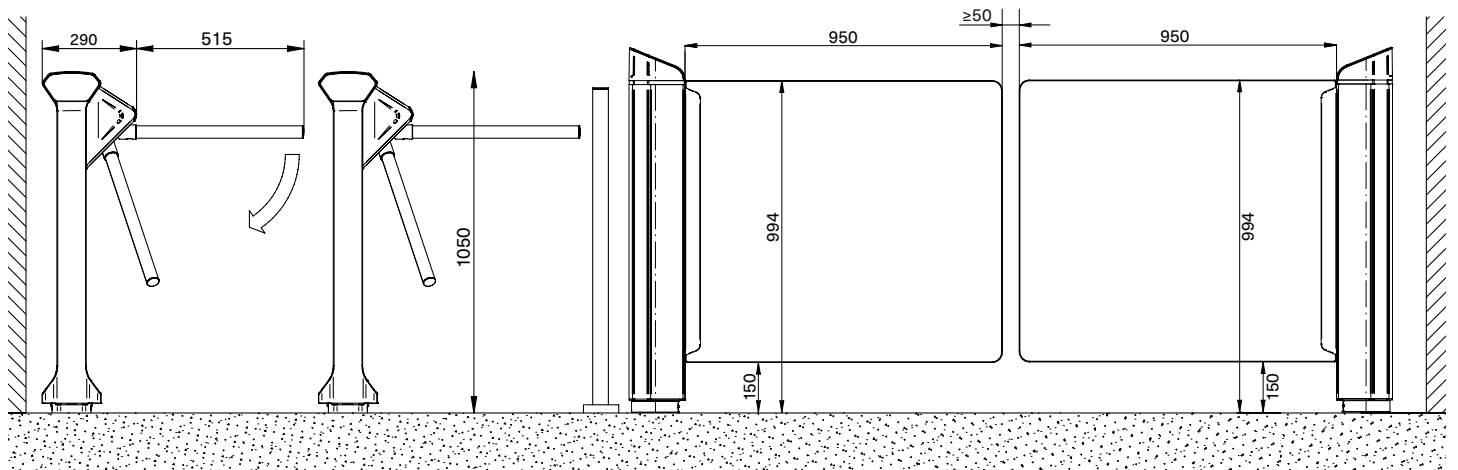

Access to Progress

Magnetic stands for pioneering products – in every way. Our access control systems for vehicles or pedestrians clear the way for thousands of people every day – at car parks, toll gates, stations, airports and in buildings. Our technology is also pioneering, however: with innovative drives, intelligent control systems and well thought-out details it provides maximum safety and longevity. Are you also on the path to Magnetic?



Vehicle barriers

Access barriers
Parking barriers
Toll barriers
Special barriers



Pedestrian gates

Turnstiles
Swing gates
Tripod gates
Retractable gates
Wing gates



Terminals

Cars
Trucks

Germany
MAGNETIC AUTOCONTROL GMBH
Grienmatt 20
79650 Schopfheim
Phone +49 7622 695-5
Fax +49 7622 695-800
E-mail info@magnetic-germany.com

Australia
MAGNETIC AUTOMATION PTY LTD
38 Metrolink Circuit
Campbellfield, VIC 3061
Phone +61 3 9339 2900
E-mail info@magnetic-oz.com

Austria
FAAC GMBH
Münchner Bundesstraße 123
5020 Salzburg
Phone +43 662 853395-0
E-mail at.info@faacgroup.com

Benelux countries
FAAC BENELUX NV/SA
Industriezone 3B
8490 Jabbeke
Belgium
Phone +32 50 320202
E-mail info@magnetic-benelux.com

MAGNETIC AUTOCONTROL GMBH
www.magnetic-access.com

Brazil
MAGNETIC AUTOCONTROL LTDA
Rua Toledo Barbosa 491.
03061-000 Belenzinho
São Paulo - SP - Brasil
Phone +55 11 5660 8500
E-mail info@magnetic-br.com

China
MAGNETIC CONTROL SYSTEMS CO., LTD
No. 3 Building, No. 51
Lane 1159, Kang Qiao (East) Road
Kang Qiao Industrial Zone, Shanghai
Phone +86 21 68182970
E-mail info@magnetic-cn.com

France
FAAC FRANCE
377 Rue Ferdinand Perrier
69808 St Priest Cedex
Phone +33 4 72 21 86 89
E-mail info@magnetic-fr.com

India
MAGNETIC FAAC INDIA PVT LTD.
PRS Centre
Plot No. 373 to 376, 2nd Floor (West Wing)
1st Cross Street, Nehru Nagar
Old Mahabalipuram Road
Kottivakkam (Opp Rayala Technopark,
Perungudi)
Chennai 600041
Phone +91 44 421 23297
E-mail info@magnetic-india.com

Ireland
NATIONAL AUTOMATION LTD
Boyle Business Park,
Boyle, Co. Roscommon
F52 V590
Phone + 353 71 9663893
E-mail sales@nal.ie

Italy
FAAC S.P.A. SOC. UNIPERSONALE
Via Calari, 10
40069 Zola Predosa (BO)
Phone +39 05161724
E-mail controlloaccessi@faacgroup.com

Middle East
FAAC MIDDLE EAST FZE
Dubai Silicon Oasis
PO Box 54886
Dubai
United Arab Emirates
Phone +971 4 3724193
E-mail info@magnetic-uae.com

N. and S. America (excl. Brazil)
FAAC INTERNATIONAL, INC
3160 Murell Road
Rockledge, FL 32955
USA
Phone +1 321 635 8585
E-mail info@magnetic-usa.com

Russia
FAAC RUSSIA
111141, г. Москва,
3-й проезд Перова Поля,
дом 8, стр. 1
Phone +7 (495) 646-87-40
E-mail info@faac.ru

Scandinavia
FAAC NORDIC AB
Box 125
284 22 Perstorp
Sweden
Phone +46 435 77 95 03
E-mail info@magnetic-nordic.com

Southeast Asia
MAGNETIC CONTROL SYSTEMS SDN. BHD
No. 17, Jalan Anggerik Mokara 31/54
Taman Perindustrian Kota Kemuning
40460 Shah Alam
Selangor Darul Ehsan
Malaysia
Phone +60 3 5123 0033
E-mail info@magnetic-malaysia.com

Spain
CLEM, S.A.U.
Avda. de la Fuente Nueva, nº 12 –
Nave 8–18
28703 San Sebastián de los Reyes
Madrid
Phone: +34 91 358 11 10
E-mail: info@clem.es

United Kingdom
FAAC ENTRANCE SOLUTIONS UK LIMITED
Phone 0333 006 3443
E-mail SALES.ESUK@FAACTECHNOLOGIES.COM